



YORK
INDUSTRIES

ISO 9001 : 2008

Quality Manufacturing since 1942

Timing Pulleys, Gears, Belts, Belt Tensioners & Assemblies

- Stock Timing Pulleys
- Custom Pulleys/Assemblies
- Universal Belt Tensioners
- Timing Belts
- Custom Gears/Assemblies
- Pulley Stock & Flanges

www.york-ind.com
Tel: 800-354-8466
Fax: 800-354-8485

RoHS
Compliant







What makes York Industries an Ideal Manufacturer/Supplier?

York Industries is the expert in small synchronous drives, with over **70 years** of success in manufacturing custom and standard timing pulleys, gears, gear racks, and custom assemblies, and as a supplier of timing belts. Our traditional values of quality and dependability have endured due to a policy of continual reinvestment that provides the company with the most up-to-date equipment for both manufacturing and inspection. Our new line of belt tensioners is a patented product of York Industries.

Single-Source Manufacturing & Customer Service

You will find that York Industries is different. The level of quality, precision and customer service we provide – from prototype to production – consistently surpasses the expectations of our customers. We quote machined-to-print solutions for your cost savings analysis. You will have a single, dedicated customer service representative... someone who knows who you are and is experienced with your needs and preferences.

ISO 9001:2008 Registered

Every stock or custom component or assembly produced at our facility is manufactured to our own uncompromising standards. York is ISO 9001:2008 certified. All products are RoHS compliant.

Quality Manufacturing

Quality...York's obsession! We take quality very seriously, from review of prints to the final inspection. Your orders are manufactured with award-winning precision, on-time delivery, and courteous, one-on-one customer service.

Technology Support

In addition to expert engineering assistance, York's proprietary DriveWorks® 2 software — a full-featured engineering tool for designing and analyzing drive systems — is provided to you without cost or obligation.

Flexibility

Upon request, York offers:

- Just-In-Time delivery
- Web-based supply chain participation
- Statistical Process Control (SPC)
- Bar coding

York Industries will gladly cross-reference any competitors' stock part numbers. At York, we are experts at adapting to whatever needs or requirements our customers may have.



TABLE OF CONTENTS

2MM GT

Pulleys	6mm wide	9-10
	9mm wide	11-12
Pulley stock		13-14
Flanges		15
Belts		16-21

3MM GT

Pulleys	9mm wide	23-24
	15mm wide	25-26
Pulley stock		27-28
Flanges		29
Belts		30-33

.080 PITCH

Pulleys	1/4 wide	35-36
	3/8 wide	37-38
Pulley stock		39-40
Flanges		41
Belts:	neoprene	42-43
	urethane/polyester	44-45
	urethane/kevlar	46-47
	trumotion	48-49

.0816 (40 DP)

Pulleys	3/16 wide	51-56
	5/16 wide	57-62
Pulley stock		63-64
Flanges		65
Belts:	urethane/polyester	66-67
	urethane/kevlar	68-69

3MM HTD

Pulleys	6mm wide	71-72
	9mm wide	73-74
	15mm wide	75-76
Pulley stock:	aluminum	77-78
	steel	79-80
Flanges:	aluminum	81
	steel	82
Belts:	neoprene	83-85
	trumotion	86-88

5MM HTD

Pulleys	9mm wide	89-90
	15mm wide	91-92
Pulley stock:	aluminum	93-94
	steel	95-96
Flanges:	aluminum	97
	steel	98

Belts:	neoprene	99-100
	trumotion	101-102

1/5 PITCH

Pulleys	1/4 wide	103-104
	3/8 wide alum.	105-113
	3/8 wide steel	114-120
Pulley stock:	aluminum	121, 122
	steel	123, 124
Flanges:	aluminum	125
	steel	126
Belts:	neoprene	127-129
	urethane/polyester	130
	urethane/kevlar	131
	twin power neoprene	132
	trumotion	133-135

3/8 PITCH

Pulleys	1/2 wide	137-138
Pulley stock:	aluminum	139
	steel	140
Flanges:	aluminum	141
Belts:	neoprene	142-143
	urethane/polyester	144
	urethane/kevlar	145
	twin power neoprene	146
	trumotion	147

ENGINEERING PAGES

Tolerances & Specifications	E2-E6
Engineering Data	E7
Automated Drive Design Software	E8-E27
Belt Materials And Construction	E28
TruMotion Belts	E29
ShaftSaver vs std. set screws	E30
Shaft-Saver - Gripping Torque Values	E31

TENSIONERS

Specifications & Engineering Data	T1-T38
-----------------------------------	--------

SPACERS

Mounting Your Tensioner With Spacers	T39
--------------------------------------	-----

CUSTOM ASSEMBLIES

Custom Pulleys and Assemblies	P1
Custom Gears and Assemblies	G1



STOCK PRODUCTS

York Industries

Manufacturing to customized specifications, and providing specialized design assistance, fast turnaround at every stage from prototype to production, and award winning quality since 1942.

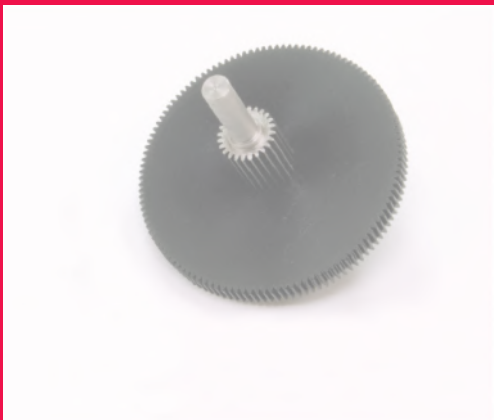

2MM GT2

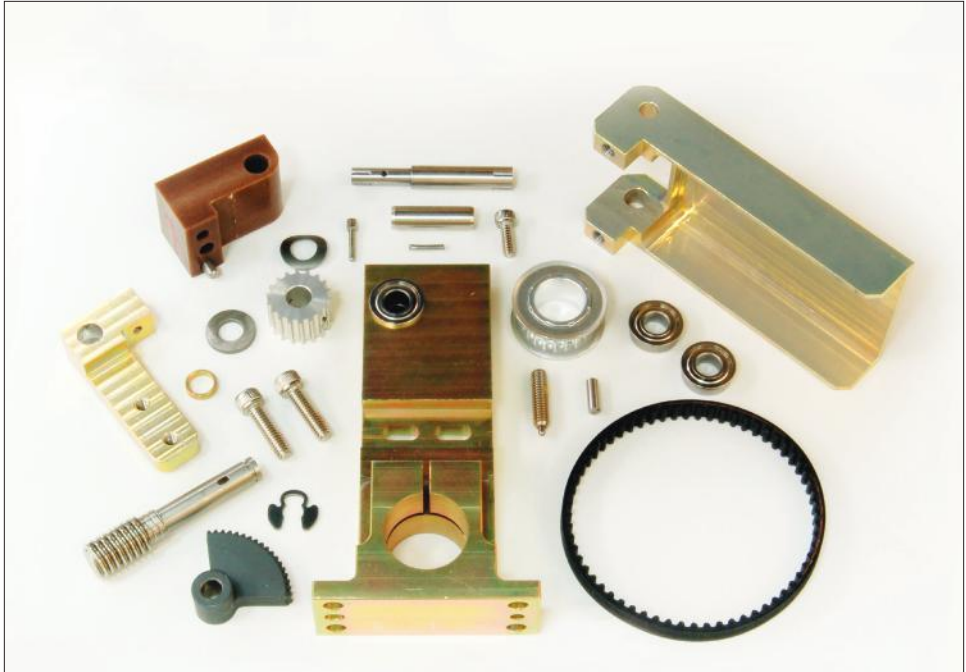

ALUMINUM WITH CLEAR ANODIZE (RoHS compliant)

FOR BELTS UP TO 6MM WIDE

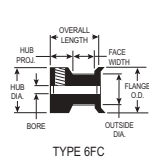

TYPE 6FC

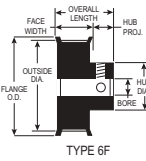

TYPE 6F

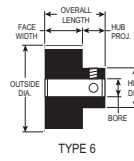

TYPE 6



PART NUMBER	NO. OF GROOVES	PITCH DIA.	OUTSIDE DIA.	FLANGE O.D.	TYPE	BORE (+.001) (-.000)	FACE WIDTH	OVERALL LENGTH	HUB PROJ.	HUB DIA.	SET SCREWS
12-2GT06-6A X 1/8	12	.301	.281	.480	6FC	1250	.285	9/16	15/64	.480	4-40(1)
SAV-12-2GT06-6A X 1/8	12	.301	.281	.480	6FC	1250	.285	9/16	15/64	.480	4-40(1)
14-2GT06-6A X 1/8	14	.351	.331	.530	6FC	1250	.285	9/16	15/64	.530	4-40(1)
SAV-14-2GT06-6A X 1/8	14	.351	.331	.530	6FC	1250	.285	9/16	15/64	.530	4-40(1)
15-2GT06-6A X 3/16	15	.376	.356	.555	6FC	1875	.285	9/16	15/64	.555	6-40(1)
SAV-15-2GT06-6A X 3/16	15	.376	.356	.555	6FC	1875	.285	9/16	15/64	.555	6-40(1)
16-2GT06-6A X 3/16	16	.401	.381	.580	6FC	1875	.285	9/16	15/64	.580	6-40(1)
SAV-16-2GT06-6A X 3/16	16	.401	.381	.580	6FC	1875	.285	9/16	15/64	.580	6-40(1)
18-2GT06-6A X 1/4	18	.451	.431	.635	6FC	2500	.285	9/16	15/64	.635	6-40(2)
SAV-18-2GT06-6A X 1/4	18	.451	.431	.635	6FC	2500	.285	9/16	15/64	.635	6-40(2)
20-2GT06-6A X 1/4	20	.501	.481	.685	6FC	2500	.285	9/16	15/64	.685	6-40(2)
SAV-20-2GT06-6A X 1/4	20	.501	.481	.685	6FC	2500	.285	9/16	15/64	.685	6-40(2)
21-2GT06-6A X 1/4	21	.526	.506	.710	6FC	2500	.285	9/16	15/64	.710	6-40(2)
SAV-21-2GT06-6A X 1/4	21	.526	.506	.710	6FC	2500	.285	9/16	15/64	.710	6-40(2)
22-2GT06-6A X 1/4	22	.551	.531	.740	6FC	2500	.285	9/16	15/64	.740	6-40(2)
SAV-22-2GT06-6A X 1/4	22	.551	.531	.740	6FC	2500	.285	9/16	15/64	.740	6-40(2)
18-2GT06-1A X 3/16	18	.451	.431	.635	6F	1875	.389	5/8	15/64	.312	6-40(2)
SAV-18-2GT06-1A X 3/16	18	.451	.431	.635	6F	1875	.389	5/8	15/64	.312	6-40(2)
20-2GT06-1A X 3/16	20	.501	.481	.685	6F	1875	.389	5/8	15/64	.364	6-40(2)
SAV-20-2GT06-1A X 3/16	20	.501	.481	.685	6F	1875	.389	5/8	15/64	.364	6-40(2)
21-2GT06-1A X 3/16	21	.526	.506	.710	6F	1875	.389	5/8	15/64	.390	6-40(2)
SAV-21-2GT06-1A X 3/16	21	.526	.506	.710	6F	1875	.389	5/8	15/64	.390	6-40(2)
22-2GT06-1A X 3/16	22	.551	.531	.740	6F	1875	.389	5/8	15/64	.390	6-40(2)
SAV-22-2GT06-1A X 3/16	22	.551	.531	.740	6F	1875	.389	5/8	15/64	.390	6-40(2)
24-2GT06-1A X 1/4	24	.602	.582	.790	6F	2500	.389	11/16	19/64	.442	6-40(2)
SAV-24-2GT06-1A X 1/4	24	.602	.582	.790	6F	2500	.389	11/16	19/64	.442	6-40(2)
28-2GT06-1A X 1/4	28	.702	.682	.895	6F	2500	.389	11/16	19/64	.494	6-40(2)
SAV-28-2GT06-1A X 1/4	28	.702	.682	.895	6F	2500	.389	11/16	19/64	.494	6-40(2)
30-2GT06-1A X 1/4	30	.752	.732	.945	6F	2500	.389	11/16	19/64	.546	8-32(2)
SAV-30-2GT06-1A X 1/4	30	.752	.732	.945	6F	2500	.389	11/16	19/64	.546	8-32(2)
32-2GT06-1A X 1/4	32	.802	.782	1.000	6F	2500	.389	11/16	19/64	.598	8-32(2)
SAV-32-2GT06-1A X 1/4	32	.802	.782	1.000	6F	2500	.389	11/16	19/64	.598	8-32(2)
36-2GT06-1A X 1/4	36	.902	.882	1.105	6F	2500	.389	11/16	19/64	.676	8-32(2)
SAV-36-2GT06-1A X 1/4	36	.902	.882	1.105	6F	2500	.389	11/16	19/64	.676	8-32(2)
40-2GT06-1A X 1/4	40	1.003	.983	1.210	6F	2500	.405	23/32	5/16	.754	8-32(2)
SAV-40-2GT06-1A X 1/4	40	1.003	.983	1.210	6F	2500	.405	23/32	5/16	.754	8-32(2)

“SAV-” in front of any standard timing pulley part # represents the Shaft-Saver version. Shaft-Saver pulleys have special setscrews that grip without damage to the shaft and allow easy pulley removal and realignment. For additional information, see our Shaft-Saver Engineering Section.

York also manufactures custom pulleys and complete assemblies
 email:support@york-ind.com web: www.york-ind.com



ALUMINUM WITH CLEAR ANODIZE (RoHS compliant)

FOR BELTS UP TO 6MM WIDE

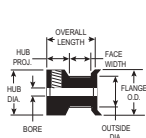

TYPE 6FC

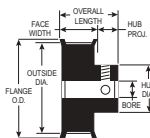

TYPE 6F

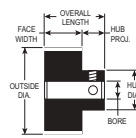

TYPE 6

PART NUMBER	NO. OF GROOVES	PITCH DIA.	OUTSIDE DIA.	FLANGE O.D.	TYPE	BORE		OVERALL LENGTH	HUB PROJ.	HUB DIA.	SET SCREWS
						(+001)	(-000)				
42-2GT06-1A X 1/4	42	1.053	1.033	1.260	6F	.2500	.405	23/32	5/16	.806	8-32(2)
SAV-42-2GT06-1A X 1/4	42	1.053	1.033	1.260	6F	.2500	.405	23/32	5/16	.806	8-32(2)
44-2GT06-1A X 1/4	44	1.103	1.083	1.315	6F	.2500	.405	23/32	5/16	.858	8-32(2)
SAV-44-2GT06-1A X 1/4	44	1.103	1.083	1.315	6F	.2500	.405	23/32	5/16	.858	8-32(2)
48-2GT06-1A X 1/4	48	1.203	1.183	1.420	6F	.2500	.405	23/32	5/16	.936	8-32(2)
SAV-48-2GT06-1A X 1/4	48	1.203	1.183	1.420	6F	.2500	.405	23/32	5/16	.936	8-32(2)
60-2GT06-1A X 1/4	60	1.504	1.484	1.730	6F	.2500	.405	23/32	5/16	1.222	8-32(2)
SAV-60-2GT06-1A X 1/4	60	1.504	1.484	1.730	6F	.2500	.405	23/32	5/16	1.222	8-32(2)
60-2GT06-2A X 1/4	60	1.504	1.484	-	6	.2500	.375	3/4	3/8	1.148	8-32(2)
SAV-60-2GT06-2A X 1/4	60	1.504	1.484	-	6	.2500	.375	3/4	3/8	1.148	8-32(2)
72-2GT06-2A X 1/4	72	1.805	1.785	-	6	.2500	.375	3/4	3/8	1.195	8-32(2)
SAV-72-2GT06-2A X 1/4	72	1.805	1.785	-	6	.2500	.375	3/4	3/8	1.195	8-32(2)
80-2GT06-2A X 5/16	80	2.005	1.985	-	6	.3125	.375	3/4	3/8	1.500	8-32(2)
SAV-80-2GT06-2A X 5/16	80	2.005	1.985	-	6	.3125	.375	3/4	3/8	1.500	8-32(2)
90-2GT06-2A X 5/16	90	2.256	2.236	-	6	.3125	.375	3/4	3/8	1.500	8-32(2)
SAV-90-2GT06-2A X 5/16	90	2.256	2.236	-	6	.3125	.375	3/4	3/8	1.500	8-32(2)
100-2GT06-2A X 5/16	100	2.506	2.486	-	6	.3125	.375	3/4	3/8	1.500	8-32(2)
SAV-100-2GT06-2A X 5/16	100	2.506	2.486	-	6	.3125	.375	3/4	3/8	1.500	8-32(2)
120-2GT06-2A X 3/8	120	3.008	2.988	-	6	.3750	.375	3/4	3/8	1.500	10-32(2)
SAV-120-2GT06-2A X 3/8	120	3.008	2.988	-	6	.3750	.375	3/4	3/8	1.500	10-32(2)

“SAV-” in front of any standard timing pulley part # represents the Shaft-Saver version. Shaft-Saver pulleys have special setscrews that grip without damage to the shaft and allow easy pulley removal and realignment. For additional information, see our Shaft-Saver Engineering Section.

ALUMINUM WITH CLEAR ANODIZE (RoHS compliant)

FOR BELTS UP TO 9MM WIDE

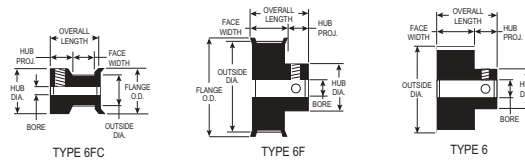

PART NUMBER	NO. OF GROOVES	PITCH DIA.	OUTSIDE DIA.	FLANGE O.D.	TYPE	BORE (+.001 / -.000)	FACE WIDTH	OVERALL LENGTH	HUB PROJ.	HUB DIA.	SET SCREWS
12-2GT09-6A X 1/8	12	.301	.281	.480	6FC	1250	.410	11/16	15/64	.480	4-40(1)
SAV-12-2GT09-6A X 1/8	12	.301	.281	.480	6FC	1250	.410	11/16	15/64	.480	4-40(1)
14-2GT09-6A X 1/8	14	.351	.331	.530	6FC	1250	.410	11/16	15/64	.530	4-40(1)
SAV-14-2GT09-6A X 1/8	14	.351	.331	.530	6FC	1250	.410	11/16	15/64	.530	4-40(1)
15-2GT09-6A X 3/16	15	.376	.356	.555	6FC	1875	.410	11/16	15/64	.555	6-40(1)
SAV-15-2GT09-6A X 3/16	15	.376	.356	.555	6FC	1875	.410	11/16	15/64	.555	6-40(1)
16-2GT09-6A X 3/16	16	.401	.381	.580	6FC	1875	.410	11/16	15/64	.580	6-40(1)
SAV-16-2GT09-6A X 3/16	16	.401	.381	.580	6FC	1875	.410	11/16	15/64	.580	6-40(1)
18-2GT09-6A X 1/4	18	.451	.431	.635	6FC	2500	.410	11/16	15/64	.635	6-40(2)
SAV-18-2GT09-6A X 1/4	18	.451	.431	.635	6FC	2500	.410	11/16	15/64	.635	6-40(2)
20-2GT09-6A X 1/4	20	.501	.481	.685	6FC	2500	.410	11/16	15/64	.685	6-40(2)
SAV-20-2GT09-6A X 1/4	20	.501	.481	.685	6FC	2500	.410	11/16	15/64	.685	6-40(2)
21-2GT09-6A X 1/4	21	.526	.506	.710	6FC	2500	.410	11/16	15/64	.710	6-40(2)
SAV-21-2GT09-6A X 1/4	21	.526	.506	.710	6FC	2500	.410	11/16	15/64	.710	6-40(2)
22-2GT09-6A X 1/4	22	.551	.531	.740	6FC	2500	.410	11/16	15/64	.740	6-40(2)
SAV-22-2GT09-6A X 1/4	22	.551	.531	.740	6FC	2500	.410	11/16	15/64	.740	6-40(2)
18-2GT09-1A X 3/16	18	.451	.431	.635	6F	1875	.514	3/4	15/64	.312	6-40(2)
SAV-18-2GT09-1A X 3/16	18	.451	.431	.635	6F	1875	.514	3/4	15/64	.312	6-40(2)
20-2GT09-1A X 3/16	20	.501	.481	.685	6F	1875	.514	3/4	15/64	.364	6-40(2)
SAV-20-2GT09-1A X 3/16	20	.501	.481	.685	6F	1875	.514	3/4	15/64	.364	6-40(2)
21-2GT09-1A X 3/16	21	.526	.506	.710	6F	1875	.514	3/4	15/64	.390	6-40(2)
SAV-21-2GT09-1A X 3/16	21	.526	.506	.710	6F	1875	.514	3/4	15/64	.390	6-40(2)
22-2GT09-1A X 3/16	22	.551	.531	.740	6F	1875	.514	3/4	15/64	.390	6-40(2)
SAV-22-2GT09-1A X 3/16	22	.551	.531	.740	6F	1875	.514	3/4	15/64	.390	6-40(2)
24-2GT09-1A X 1/4	24	.602	.582	.790	6F	2500	.514	13/16	19/64	.442	6-40(2)
SAV-24-2GT09-1A X 1/4	24	.602	.582	.790	6F	2500	.514	13/16	19/64	.442	6-40(2)
28-2GT09-1A X 1/4	28	.702	.682	.895	6F	2500	.514	13/16	19/64	.494	6-40(2)
SAV-28-2GT09-1A X 1/4	28	.702	.682	.895	6F	2500	.514	13/16	19/64	.494	6-40(2)
30-2GT09-1A X 1/4	30	.752	.732	.945	6F	2500	.514	13/16	19/64	.546	8-32(2)
SAV-30-2GT09-1A X 1/4	30	.752	.732	.945	6F	2500	.514	13/16	19/64	.546	8-32(2)
32-2GT09-1A X 1/4	32	.802	.782	1.000	6F	2500	.514	13/16	19/64	.598	8-32(2)
SAV-32-2GT09-1A X 1/4	32	.802	.782	1.000	6F	2500	.514	13/16	19/64	.598	8-32(2)
36-2GT09-1A X 1/4	36	.902	.882	1.105	6F	2500	.514	13/16	19/64	.676	8-32(2)
SAV-36-2GT09-1A X 1/4	36	.902	.882	1.105	6F	2500	.514	13/16	19/64	.676	8-32(2)
40-2GT09-1A X 1/4	40	1.003	.983	1.210	6F	2500	.530	27/32	5/16	.754	8-32(2)
SAV-40-2GT09-1A X 1/4	40	1.003	.983	1.210	6F	2500	.530	27/32	5/16	.754	8-32(2)

“SAV-” in front of any standard timing pulley part # represents the Shaft-Saver version. Shaft-Saver pulleys have special setscrews that grip without damage to the shaft and allow easy pulley removal and realignment. For additional information, see our Shaft-Saver Engineering Section.

York also manufactures custom pulleys and complete assemblies
 email:support@york-ind.com web: www.york-ind.com



ALUMINUM WITH CLEAR ANODIZE (RoHS compliant)

FOR BELTS UP TO 9MM WIDE

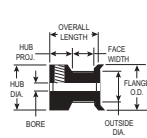

TYPE 6FC

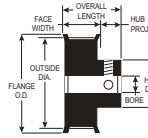

TYPE 6F

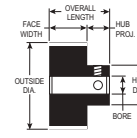

TYPE 6

PART NUMBER	NO. OF GROOVES	PITCH DIA.	OUTSIDE DIA.	FLANGE O.D.	BORE TYPE	BORE (+.001) (-.000)	FACE WIDTH	OVERALL LENGTH	HUB PROJ.	HUB DIA.	SET SCREWS
42-2GT09-1A X 1/4	42	1.053	1.033	1.260	6F	.2500	.530	27/32	5/16	.806	8-32(2)
SAV-42-2GT09-1A X 1/4	42	1.053	1.033	1.260	6F	.2500	.530	27/32	5/16	.806	8-32(2)
44-2GT09-1A X 1/4	44	1.103	1.083	1.315	6F	.2500	.530	27/32	5/16	.858	8-32(2)
SAV-44-2GT09-1A X 1/4	44	1.103	1.083	1.315	6F	.2500	.530	27/32	5/16	.858	8-32(2)
48-2GT09-1A X 1/4	48	1.203	1.183	1.420	6F	.2500	.530	27/32	5/16	.936	8-32(2)
SAV-48-2GT09-1A X 1/4	48	1.203	1.183	1.420	6F	.2500	.530	27/32	5/16	.936	8-32(2)
60-2GT09-1A X 1/4	60	1.504	1.484	1.730	6F	.2500	.530	27/32	5/16	1.222	8-32(2)
SAV-60-2GT09-1A X 1/4	60	1.504	1.484	1.730	6F	.2500	.530	27/32	5/16	1.222	8-32(2)
60-2GT09-2A X 1/4	60	1.504	1.484	—	6	.2500	.500	7/8	3/8	1.148	8-32(2)
SAV-60-2GT09-2A X 1/4	60	1.504	1.484	—	6	.2500	.500	7/8	3/8	1.148	8-32(2)
72-2GT09-2A X 1/4	72	1.805	1.785	—	6	.2500	.500	7/8	3/8	1.195	8-32(2)
SAV-72-2GT09-2A X 1/4	72	1.805	1.785	—	6	.2500	.500	7/8	3/8	1.195	8-32(2)
80-2GT09-2A X 5/16	80	2.005	1.985	—	6	.3125	.500	7/8	3/8	1.500	8-32(2)
SAV-80-2GT09-2A X 5/16	80	2.005	1.985	—	6	.3125	.500	7/8	3/8	1.500	8-32(2)
90-2GT09-2A X 5/16	90	2.256	2.236	—	6	.3125	.500	7/8	3/8	1.500	8-32(2)
SAV-90-2GT09-2A X 5/16	90	2.256	2.236	—	6	.3125	.500	7/8	3/8	1.500	8-32(2)
100-2GT09-2A X 5/16	100	2.506	2.486	—	6	.3125	.500	7/8	3/8	1.500	8-32(2)
SAV-100-2GT09-2A X 5/16	100	2.506	2.486	—	6	.3125	.500	7/8	3/8	1.500	8-32(2)
120-2GT09-2A X 3/8	120	3.008	2.988	—	6	.3750	.500	7/8	3/8	1.500	10-32(2)
SAV-120-2GT09-2A X 3/8	120	3.008	2.988	—	6	.3750	.500	7/8	3/8	1.500	10-32(2)

“SAV.” in front of any standard timing pulley part # represents the Shaft-Saver version. Shaft-Saver pulleys have special setscrews that grip without damage to the shaft and allow easy pulley removal and realignment. For additional information, see our Shaft-Saver Engineering Section.

ALUMINUM 6061-T6 (RoHS compliant)

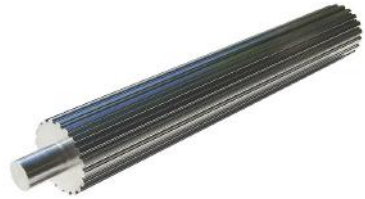
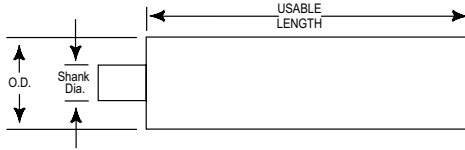

PART NUMBER	NO. OF GROOVES	PITCH DIA.	OUTSIDE DIA.	SHANK DIA.	USEABLE LENGTH
12-2GT-P-2A	12	.301	.281	5/16	2"
13-2GT-P-2A	13	.326	.306	3/8	2"
14-2GT-P-3A	14	.351	.331	3/8	3"
15-2GT-P-3A	15	.376	.356	7/16	3"
16-2GT-P-3A	16	.401	.381	7/16	3"
17-2GT-P-3A	17	.426	.406	7/16	3"
18-2GT-P-3A	18	.451	.431	1/2	3"
19-2GT-P-3A	19	.476	.456	1/2	3"
20-2GT-P-4A	20	.501	.481	3/8	4"
21-2GT-P-4A	21	.526	.506	3/8	4"
22-2GT-P-4A	22	.551	.531	3/8	4"
23-2GT-P-4A	23	.576	.556	3/8	4"
24-2GT-P-5A	24	.602	.582	1/2	5"
26-2GT-P-5A	26	.652	.632	1/2	5"
28-2GT-P-5A	28	.702	.682	1/2	5"
30-2GT-P-6A	30	.752	.732	1/2	6"
32-2GT-P-6A	32	.802	.782	1/2	6"
34-2GT-P-6A	34	.852	.832	1/2	6"
36-2GT-P-6A	36	.902	.882	1/2	6"
38-2GT-P-6A	38	.952	.932	1/2	6"

York also manufactures custom pulleys and complete assemblies
 email:support@york-ind.com web: www.york-ind.com



ALUMINUM 6061-T6 (RoHS compliant)

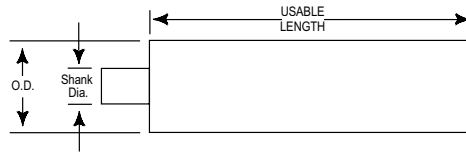
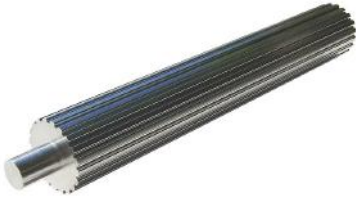

PART NUMBER	NO. OF GROOVES	PITCH DIA.	OUTSIDE DIA.	SHANK DIA.	USEABLE LENGTH
40-2GT-P-7A	40	1.003	.983	1/2	7"
42-2GT-P-7A	42	1.053	1.033	1/2	7"
43-2GT-P-7A	43	1.078	1.058	1/2	7"
44-2GT-P-7A	44	1.103	1.083	1/2	7"
45-2GT-P-7A	45	1.128	1.108	1/2	7"
46-2GT-P-7A	46	1.153	1.133	1/2	7"
48-2GT-P-7A	48	1.203	1.183	1/2	7"
49-2GT-P-7A	49	1.228	1.208	1/2	7"
52-2GT-P-7A	52	1.303	1.283	1/2	7"
55-2GT-P-7A	55	1.379	1.359	1/2	7"
56-2GT-P-7A	56	1.404	1.384	1/2	7"
60-2GT-P-8A	60	1.504	1.484	1/2	8"
65-2GT-P-8A	65	1.629	1.609	1/2	8"
70-2GT-P-8A	70	1.754	1.734	1/2	8"
72-2GT-P-8A	72	1.805	1.785	1/2	8"
75-2GT-P-8A	75	1.880	1.860	1/2	8"
80-2GT-P-8A	80	2.005	1.985	3/4	8"
90-2GT-P-8A	90	2.256	2.236	3/4	8"
96-2GT-P-8A	96	2.406	2.386	3/4	8"
100-2GT-P-8A	100	2.506	2.486	3/4	8"
110-2GT-P-8A	110	2.757	2.737	3/4	8"
120-2GT-P-8A	120	3.008	2.988	3/4	8"

ALUMINUM (RoHS compliant)

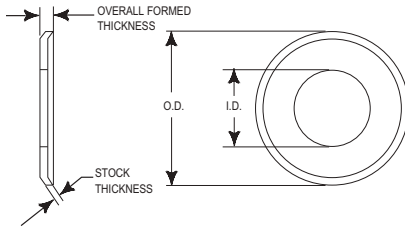

PART NUMBER	INSIDE DIA.	OUTSIDE DIA.	STOCK THICKNESS	OVERALL FORMED THICKNESS
10-2GT-F9A	.155	.425	.025	.045
11-2GT-F9A	.181	.450	.025	.045
12-2GT-F9A	.205	.480	.025	.045
13-2GT-F9A	.230	.505	.025	.045
14-2GT-F9A	.255	.530	.025	.045
15-2GT-F9A	.280	.555	.025	.045
16-2GT-F9A	.305	.580	.025	.045
18-2GT-F9A	.355	.635	.032	.052
20-2GT-F9A	.405	.685	.032	.052
21-2GT-F9A	.430	.710	.032	.052
22-2GT-F9A	.452	.740	.032	.052
24-2GT-F9A	.504	.790	.032	.052
25-2GT-F9A	.530	.815	.032	.052
26-2GT-F9A	.556	.840	.032	.052
28-2GT-F9A	.574	.895	.032	.052
30-2GT-F9A	.626	.945	.032	.052
32-2GT-F9A	.678	1.000	.032	.052
33-2GT-F9A	.704	1.025	.032	.052
34-2GT-F9A	.722	1.050	.032	.052
35-2GT-F9A	.748	1.080	.032	.052
36-2GT-F9A	.774	1.105	.032	.052
38-2GT-F9A	.826	1.155	.032	.052
40-2GT-F9A	.874	1.210	.040	.060
42-2GT-F9A	.926	1.260	.040	.060
44-2GT-F9A	.978	1.315	.040	.060
45-2GT-F9A	1.004	1.340	.040	.060
48-2GT-F9A	1.058	1.420	.040	.060
50-2GT-F9A	1.110	1.470	.040	.060
54-2GT-F9A	1.200	1.575	.040	.060
60-2GT-F9A	1.356	1.730	.040	.060

York also manufactures custom pulleys and complete assemblies
 email: support@york-ind.com web: www.york-ind.com



BLACK NEOPRENE, Fiberglass Cord (RoHS compliant)

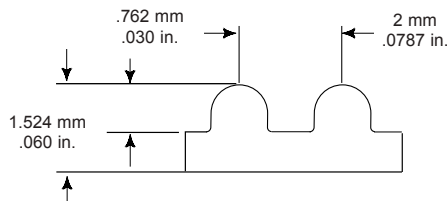

BELT NUMBER	WIDTHS				PITCH LENGTH (MM)	NO. OF TEETH
	4MM	6MM	9MM	12MM		
74-2GT	04	06	09	12	74	37
76-2GT	04	06	09	12	76	38
100-2GT	04	06	09	12	100	50
112-2GT	04	06	09	12	112	56
126-2GT	04	06	09	12	126	63
132-2GT	04	06	09	12	132	66
134-2GT	04	06	09	12	134	67
136-2GT	04	06	09	12	136	68
140-2GT	04	06	09	12	140	70
142-2GT	04	06	09	12	142	71
152-2GT	04	06	09	12	152	76
158-2GT	04	06	09	12	158	79
160-2GT	04	06	09	12	160	80
164-2GT	04	06	09	12	164	82
166-2GT	04	06	09	12	166	83
172-2GT	04	06	09	12	172	86
180-2GT	04	06	09	12	180	90
186-2GT	04	06	09	12	186	93
192-2GT	04	06	09	12	192	96
200-2GT	04	06	09	12	200	100
202-2GT	04	06	09	12	202	101
208-2GT	04	06	09	12	208	104
210-2GT	04	06	09	12	210	105
212-2GT	04	06	09	12	212	106
216-2GT	04	06	09	12	216	108
220-2GT	04	06	09	12	220	110
224-2GT	04	06	09	12	224	112
232-2GT	04	06	09	12	232	116
236-2GT	04	06	09	12	236	118
240-2GT	04	06	09	12	240	120

If you don't see the belt you need – call York!

YORK
ISO 9001: 2008 Registered

303 Nassau Blvd., Garden City Park, NY 11040

Tel: 1-800 354 8466 Fax: 1-800 354 8485

BLACK NEOPRENE, Fiberglass Cord (RoHS compliant)

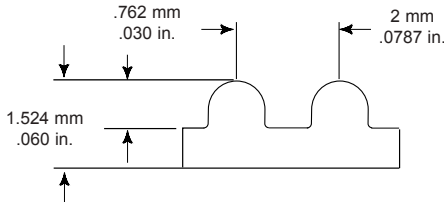

BELT NUMBER	WIDTHS				PITCH LENGTH (MM)	NO. OF TEETH
	4MM	6MM	9MM	12MM		
242-2GT	04	06	09	12	242	121
250-2GT	04	06	09	12	250	125
252-2GT	04	06	09	12	252	126
258-2GT	04	06	09	12	258	129
264-2GT	04	06	09	12	264	132
278-2GT	04	06	09	12	278	139
280-2GT	04	06	09	12	280	140
286-2GT	04	06	09	12	286	143
288-2GT	04	06	09	12	288	144
300-2GT	04	06	09	12	300	150
318-2GT	04	06	09	12	318	159
320-2GT	04	06	09	12	320	160
322-2GT	04	06	09	12	322	161
332-2GT	04	06	09	12	332	166
346-2GT	04	06	09	12	346	173
350-2GT	04	06	09	12	350	175
356-2GT	04	06	09	12	356	178
364-2GT	04	06	09	12	364	182
370-2GT	04	06	09	12	370	185
380-2GT	04	06	09	12	380	190
386-2GT	04	06	09	12	386	193
392-2GT	04	06	09	12	392	196
400-2GT	04	06	09	12	400	200
406-2GT	04	06	09	12	406	203
420-2GT	04	06	09	12	420	210
428-2GT	04	06	09	12	428	214
430-2GT	04	06	09	12	430	215
456-2GT	04	06	09	12	456	228

Need a clean, low dust belt? See TruMotion belts.

York also manufactures custom pulleys and complete assemblies
 email:support@york-ind.com web: www.york-ind.com



BLACK NEOPRENE, Fiberglass Cord (RoHS compliant)

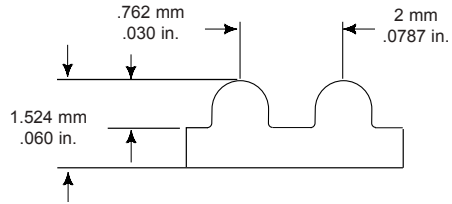

BELT NUMBER	WIDTHS				PITCH LENGTH (MM)	NO. OF TEETH
	4MM	6MM	9MM	12MM		
470-2GT	04	06	09	12	470	235
474-2GT	04	06	09	12	474	237
488-2GT	04	06	09	12	488	244
502-2GT	04	06	09	12	502	251
504-2GT	04	06	09	12	504	252
528-2GT	04	06	09	12	528	264
544-2GT	04	06	09	12	544	272
552-2GT	04	06	09	12	552	276
576-2GT	04	06	09	12	576	288
600-2GT	04	06	09	12	600	300
640-2GT	04	06	09	12	640	320
660-2GT	04	06	09	12	660	330
696-2GT	04	06	09	12	696	348
744-2GT	04	06	09	12	744	372
1164-2GT	04	06	09	12	1164	582
1700-2GT	04	06	09	12	1700	850

If you don't see the belt you need – call York!

YORK

ISO 9001: 2008 Registered

303 Nassau Blvd., Garden City Park, NY 11040

Tel: 1-800 354 8466 Fax: 1-800 354 8485

Cream Colored Engineered Polymer with Fiberglass Cord (RoHS compliant)

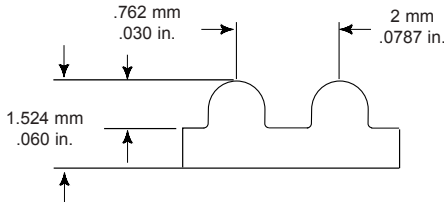

BELT NUMBER	WIDTHS				PITCH LENGTH (MM)	NO. OF TEETH
	4MM	6MM	9MM	12MM		
TM-74-2GT	04	06	09	12	74	37
TM-76-2GT	04	06	09	12	76	38
TM-100-2GT	04	06	09	12	100	50
TM-112-2GT	04	06	09	12	112	56
TM-126-2GT	04	06	09	12	126	63
TM-132-2GT	04	06	09	12	132	66
TM-134-2GT	04	06	09	12	134	67
TM-136-2GT	04	06	09	12	136	68
TM-140-2GT	04	06	09	12	140	70
TM-142-2GT	04	06	09	12	142	71
TM-152-2GT	04	06	09	12	152	76
TM-158-2GT	04	06	09	12	158	79
TM-160-2GT	04	06	09	12	160	80
TM-164-2GT	04	06	09	12	164	82
TM-166-2GT	04	06	09	12	166	83
TM-172-2GT	04	06	09	12	172	86
TM-180-2GT	04	06	09	12	180	90
TM-186-2GT	04	06	09	12	186	93
TM-192-2GT	04	06	09	12	192	96
TM-200-2GT	04	06	09	12	200	100
TM-202-2GT	04	06	09	12	202	101
TM-208-2GT	04	06	09	12	208	104
TM-210-2GT	04	06	09	12	210	105
TM-212-2GT	04	06	09	12	212	106
TM-216-2GT	04	06	09	12	216	108
TM-220-2GT	04	06	09	12	220	110
TM-224-2GT	04	06	09	12	224	112
TM-232-2GT	04	06	09	12	232	116
TM-236-2GT	04	06	09	12	236	118
TM-240-2GT	04	06	09	12	240	120

If you don't see the belt you need – call York!

York also manufactures custom pulleys and complete assemblies
 email:support@york-ind.com web: www.york-ind.com



Cream Colored Engineered Polymer with Fiberglass Cord (RoHS compliant)

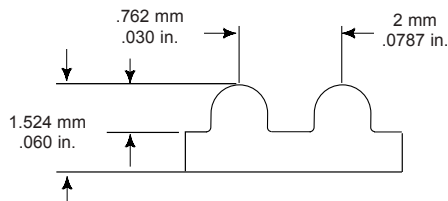

BELT NUMBER	WIDTHS				PITCH LENGTH (MM)	NO. OF TEETH
	4MM	6MM	9MM	12MM		
TM-242-2GT	04	06	09	12	242	121
TM-250-2GT	04	06	09	12	250	125
TM-252-2GT	04	06	09	12	252	126
TM-258-2GT	04	06	09	12	258	129
TM-264-2GT	04	06	09	12	264	132
TM-278-2GT	04	06	09	12	278	139
TM-280-2GT	04	06	09	12	280	140
TM-286-2GT	04	06	09	12	286	143
TM-288-2GT	04	06	09	12	288	144
TM-300-2GT	04	06	09	12	300	150
TM-318-2GT	04	06	09	12	318	159
TM-320-2GT	04	06	09	12	320	160
TM-322-2GT	04	06	09	12	322	161
TM-332-2GT	04	06	09	12	332	166
TM-346-2GT	04	06	09	12	346	173
TM-350-2GT	04	06	09	12	350	175
TM-356-2GT	04	06	09	12	356	178
TM-364-2GT	04	06	09	12	364	182
TM-370-2GT	04	06	09	12	370	185
TM-380-2GT	04	06	09	12	380	190
TM-386-2GT	04	06	09	12	386	193
TM-392-2GT	04	06	09	12	392	196
TM-400-2GT	04	06	09	12	400	200
TM-406-2GT	04	06	09	12	406	203
TM-420-2GT	04	06	09	12	420	210
TM-428-2GT	04	06	09	12	428	214
TM-430-2GT	04	06	09	12	430	215
TM-456-2GT	04	06	09	12	456	228

If you don't see the belt you need – call York!

Cream Colored Engineered Polymer with Fiberglass Cord (RoHS compliant)

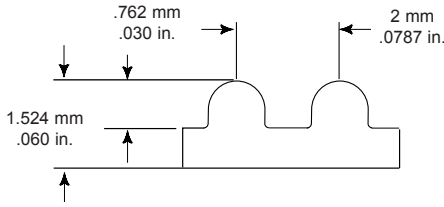

BELT NUMBER	WIDTHS				PITCH LENGTH (MM)	NO. OF TEETH
	4MM	6MM	9MM	12MM		
TM-470-2GT	04	06	09	12	470	235
TM-474-2GT	04	06	09	12	474	237
TM-488-2GT	04	06	09	12	488	244
TM-502-2GT	04	06	09	12	502	251
TM-504-2GT	04	06	09	12	504	252
TM-528-2GT	04	06	09	12	528	264
TM-544-2GT	04	06	09	12	544	272
TM-552-2GT	04	06	09	12	552	276
TM-576-2GT	04	06	09	12	576	288
TM-600-2GT	04	06	09	12	600	300
TM-640-2GT	04	06	09	12	640	320
TM-660-2GT	04	06	09	12	660	330
TM-696-2GT	04	06	09	12	696	348
TM-744-2GT	04	06	09	12	744	372
TM-1164-2GT	04	06	09	12	1164	582
TM-1700-2GT	04	06	09	12	1700	850

If you don't see the belt you need – call York!



3MM GT2

3MM GT2



TIMING BELT PULLEYS

3MM GT2 PITCH

ALUMINUM WITH CLEAR ANODIZE (RoHS compliant)

FOR BELTS UP TO 9MM WIDE

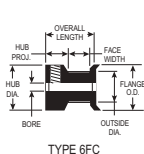

TYPE 6FC

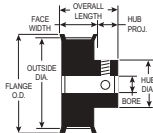

TYPE 6F

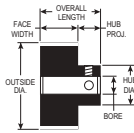

TYPE 6



PART NUMBER	NO. OF GROOVES	PITCH DIA.	OUTSIDE DIA.	FLANGE O.D.	TYPE	BORE (+.001 (-.000))		OVERALL LENGTH	HUB DIA.	SET SCREWS (2@90°)
						FACE WIDTH	FACE			
16-3GT09-6A X 1/8	16	.602	.572	.710	6FC	1.250	.401	.691	.710	6-40
SAV-16-3GT09-6A X 1/8	16	.602	.572	.710	6FC	1.250	.401	.691	.710	6-40
17-3GT09-6A X 1/8	17	.639	.609	.740	6FC	1.250	.401	.691	.740	6-40
SAV-17-3GT09-6A X 1/8	17	.639	.609	.740	6FC	1.250	.401	.691	.740	6-40
18-3GT09-1A X 3/16	18	.677	.647	.790	6F	1.875	.506	.821	.442	4-40
SAV-18-3GT09-1A X 3/16	18	.677	.647	.790	6F	1.875	.506	.821	.442	4-40
19-3GT09-1A X 3/16	19	.714	.684	.827	6F	1.875	.506	.821	.479	4-40
SAV-19-3GT09-1A X 3/16	19	.714	.684	.827	6F	1.875	.506	.821	.479	4-40
20-3GT09-1A X 3/16	20	.752	.722	.895	6F	1.875	.506	.821	.500	4-40
SAV-20-3GT09-1A X 3/16	20	.752	.722	.895	6F	1.875	.506	.821	.500	4-40
21-3GT09-1A X 3/16	21	.790	.760	.895	6F	1.875	.506	.821	.500	4-40
SAV-21-3GT09-1A X 3/16	21	.790	.760	.895	6F	1.875	.506	.821	.500	4-40
22-3GT09-1A X 3/16	22	.827	.797	.945	6F	1.875	.506	.821	.562	4-40
SAV-22-3GT09-1A X 3/16	22	.827	.797	.945	6F	1.875	.506	.821	.562	4-40
24-3GT09-1A X 1/4	24	.902	.872	1.025	6F	2.500	.506	.821	.625	6-40
SAV-24-3GT09-1A X 1/4	24	.902	.872	1.025	6F	2.500	.506	.821	.625	6-40
25-3GT09-1A X 1/4	25	.940	.910	1.060	6F	2.500	.506	.821	.625	6-40
SAV-25-3GT09-1A X 1/4	25	.940	.910	1.060	6F	2.500	.506	.821	.625	6-40
26-3GT09-1A X 1/4	26	.977	.947	1.105	6F	2.500	.506	.821	.625	6-40
SAV-26-3GT09-1A X 1/4	26	.977	.947	1.105	6F	2.500	.506	.821	.625	6-40
28-3GT09-1A X 1/4	28	1.053	1.023	1.173	6F	2.500	.506	.821	.701	6-40
SAV-28-3GT09-1A X 1/4	28	1.053	1.023	1.173	6F	2.500	.506	.821	.701	6-40
30-3GT09-1A X 1/4	30	1.128	1.098	1.250	6F	2.500	.506	.821	.776	8-32
SAV-30-3GT09-1A X 1/4	30	1.128	1.098	1.250	6F	2.500	.506	.821	.776	8-32
32-3GT09-1A X 1/4	32	1.203	1.173	1.323	6F	2.500	.506	.821	.851	8-32
SAV-32-3GT09-1A X 1/4	32	1.203	1.173	1.323	6F	2.500	.506	.821	.851	8-32
34-3GT09-1A X 1/4	34	1.278	1.248	1.398	6F	2.500	.527	.833	.921	8-32
SAV-34-3GT09-1A X 1/4	34	1.278	1.248	1.398	6F	2.500	.527	.833	.921	8-32
36-3GT09-1A X 1/4	36	1.353	1.323	1.478	6F	2.500	.527	.833	1.000	8-32
SAV-36-3GT09-1A X 1/4	36	1.353	1.323	1.478	6F	2.500	.527	.833	1.000	8-32
38-3GT09-1A X 1/4	38	1.429	1.399	1.549	6F	2.500	.527	.833	1.075	8-32
SAV-38-3GT09-1A X 1/4	38	1.429	1.399	1.549	6F	2.500	.527	.833	1.075	8-32
40-3GT09-1A X 1/4	40	1.504	1.474	1.625	6F	2.500	.527	.833	1.150	8-32
SAV-40-3GT09-1A X 1/4	40	1.504	1.474	1.625	6F	2.500	.527	.833	1.150	8-32
42-3GT09-1A X 1/4	42	1.579	1.549	1.730	6F	2.500	.527	.833	1.150	8-32
SAV-42-3GT09-1A X 1/4	42	1.579	1.549	1.730	6F	2.500	.527	.833	1.150	8-32

“SAV.” in front of any standard timing pulley part # represents the Shaft-Saver version. Shaft-Saver pulleys have special setscrews that grip without damage to the shaft and allow easy pulley removal and realignment. For additional information, see our Shaft-Saver Engineering Section.

York also manufactures custom pulleys and complete assemblies
 email:support@york-ind.com web: www.york-ind.com



ALUMINUM WITH CLEAR ANODIZE (RoHS compliant)

FOR BELTS UP TO 9MM WIDE

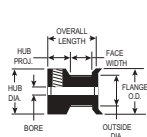

TYPE 6FC

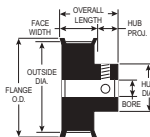

TYPE 6F

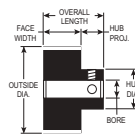

TYPE 6

PART NUMBER	NO. OF GROOVES	PITCH DIA.	OUTSIDE DIA.	FLANGE O.D.	BORE (+.001) (-.000)	FACE WIDTH	OVERALL LENGTH	HUB DIA.	SET SCREWS (2@90°)
44-3GT09-1A X 1/4	44	1.654	1.624	1.775	6F	.2500	.527	.833	8-32
SAV-44-3GT09-1A X 1/4	44	1.654	1.624	1.775	6F	.2500	.527	.833	8-32
45-3GT09-1A X 1/4	45	1.692	1.662	1.775	6F	.2500	.527	.833	8-32
SAV-45-3GT09-1A X 1/4	45	1.692	1.662	1.775	6F	.2500	.527	.833	8-32
48-3GT09-2A X 5/16	48	1.805	1.775	—	6	.3125	.500	.875	8-32
SAV-48-3GT09-2A X 5/16	48	1.805	1.775	—	6	.3125	.500	.875	8-32
50-3GT09-2A X 5/16	50	1.880	1.850	—	6	.3125	.500	.875	8-32
SAV-50-3GT09-2A X 5/16	50	1.880	1.850	—	6	.3125	.500	.875	8-32
56-3GT09-2A X 5/16	56	2.105	2.075	—	6	.3125	.500	.875	8-32
SAV-56-3GT09-2A X 5/16	56	2.105	2.075	—	6	.3125	.500	.875	8-32
60-3GT09-2A X 5/16	60	2.256	2.226	—	6	.3125	.500	.875	8-32
SAV-60-3GT09-2A X 5/16	60	2.256	2.226	—	6	.3125	.500	.875	8-32
62-3GT09-2A X 5/16	62	2.331	2.301	—	6	.3125	.500	.875	8-32
SAV-62-3GT09-2A X 5/16	62	2.331	2.301	—	6	.3125	.500	.875	8-32
68-3GT09-2A X 5/16	68	2.557	2.527	—	6	.3125	.500	.875	8-32
SAV-68-3GT09-2A X 5/16	68	2.557	2.527	—	6	.3125	.500	.875	8-32
72-3GT09-2A X 5/16	72	2.707	2.677	—	6	.3125	.500	.875	8-32
SAV-72-3GT09-2A X 5/16	72	2.707	2.677	—	6	.3125	.500	.875	8-32
74-3GT09-2A X 5/16	74	2.782	2.752	—	6	.3125	.500	.875	8-32
SAV-74-3GT09-2A X 5/16	74	2.782	2.752	—	6	.3125	.500	.875	8-32
80-3GT09-2A X 5/16	80	3.008	2.978	—	6	.3125	.500	.875	8-32
SAV-80-3GT09-2A X 5/16	80	3.008	2.978	—	6	.3125	.500	.875	8-32

“SAV-” in front of any standard timing pulley part # represents the Shaft-Saver version. Shaft-Saver pulleys have special setscrews that grip without damage to the shaft and allow easy pulley removal and realignment. For additional information, see our Shaft-Saver Engineering Section.

TIMING BELT PULLEYS

3MM GT2 PITCH

ALUMINUM WITH CLEAR ANODIZE (RoHS compliant)

FOR BELTS UP TO 15MM WIDE

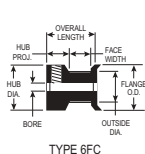

TYPE 6FC

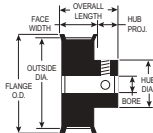

TYPE 6F

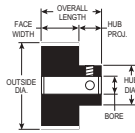

TYPE 6



PART NUMBER	NO. OF GROOVES	PITCH DIA.	OUTSIDE DIA.	FLANGE O.D.	TYPE	BORE (+.001 (-.000))		OVERALL LENGTH	HUB DIA.	SET SCREWS (2@90°)
						FACE WIDTH	FACE			
16-3GT15-6A X 1/8	16	.602	.572	.710	6FC	1250	.637	.927	.710	6-40
SAV-16-3GT15-6A X 1/8	16	.602	.572	.710	6FC	1250	.637	.927	.710	6-40
17-3GT15-6A X 1/8	17	.639	.609	.740	6FC	1250	.637	.927	.740	6-40
SAV-17-3GT15-6A X 1/8	17	.639	.609	.740	6FC	1250	.637	.927	.740	6-40
18-3GT15-1A X 3/16	18	.677	.647	.790	6F	1875	.742	1.057	.442	4-40
SAV-18-3GT15-1A X 3/16	18	.677	.647	.790	6F	1875	.742	1.057	.442	4-40
19-3GT15-1A X 3/16	19	.714	.684	.827	6F	1875	.742	1.057	.479	4-40
SAV-19-3GT15-1A X 3/16	19	.714	.684	.827	6F	1875	.742	1.057	.479	4-40
20-3GT15-1A X 3/16	20	.752	.722	.895	6F	1875	.742	1.057	.500	4-40
SAV-20-3GT15-1A X 3/16	20	.752	.722	.895	6F	1875	.742	1.057	.500	4-40
21-3GT15-1A X 3/16	21	.790	.760	.895	6F	1875	.742	1.057	.500	4-40
SAV-21-3GT15-1A X 3/16	21	.790	.760	.895	6F	1875	.742	1.057	.500	4-40
22-3GT15-1A X 3/16	22	.827	.797	.945	6F	1875	.742	1.057	.562	4-40
SAV-22-3GT15-1A X 3/16	22	.827	.797	.945	6F	1875	.742	1.057	.562	4-40
24-3GT15-1A X 1/4	24	.902	.872	1.025	6F	2500	.742	1.057	.625	6-40
SAV-24-3GT15-1A X 1/4	24	.902	.872	1.025	6F	2500	.742	1.057	.625	6-40
25-3GT15-1A X 1/4	25	.940	.910	1.060	6F	2500	.742	1.057	.625	6-40
SAV-25-3GT15-1A X 1/4	25	.940	.910	1.060	6F	2500	.742	1.057	.625	6-40
26-3GT15-1A X 1/4	26	.977	.947	1.105	6F	2500	.742	1.057	.625	6-40
SAV-26-3GT15-1A X 1/4	26	.977	.947	1.105	6F	2500	.742	1.057	.625	6-40
28-3GT15-1A X 1/4	28	1.053	1.023	1.173	6F	2500	.742	1.057	.701	6-40
SAV-28-3GT15-1A X 1/4	28	1.053	1.023	1.173	6F	2500	.742	1.057	.701	6-40
30-3GT15-1A X 1/4	30	1.128	1.098	1.250	6F	2500	.742	1.057	.776	8-32
SAV-30-3GT15-1A X 1/4	30	1.128	1.098	1.250	6F	2500	.742	1.057	.776	8-32
32-3GT15-1A X 1/4	32	1.203	1.173	1.323	6F	2500	.742	1.057	.851	8-32
SAV-32-3GT15-1A X 1/4	32	1.203	1.173	1.323	6F	2500	.742	1.057	.851	8-32
34-3GT15-1A X 1/4	34	1.278	1.248	1.398	6F	2500	.763	1.069	.921	8-32
SAV-34-3GT15-1A X 1/4	34	1.278	1.248	1.398	6F	2500	.763	1.069	.921	8-32
36-3GT15-1A X 1/4	36	1.353	1.323	1.478	6F	2500	.763	1.069	1.000	8-32
SAV-36-3GT15-1A X 1/4	36	1.353	1.323	1.478	6F	2500	.763	1.069	1.000	8-32
38-3GT15-1A X 1/4	38	1.429	1.399	1.549	6F	2500	.763	1.069	1.075	8-32
SAV-38-3GT15-1A X 1/4	38	1.429	1.399	1.549	6F	2500	.763	1.069	1.075	8-32
40-3GT15-1A X 1/4	40	1.504	1.474	1.625	6F	2500	.763	1.069	1.150	8-32
SAV-40-3GT15-1A X 1/4	40	1.504	1.474	1.625	6F	2500	.763	1.069	1.150	8-32
42-3GT15-1A X 1/4	42	1.579	1.549	1.730	6F	2500	.763	1.069	1.150	8-32
SAV-42-3GT15-1A X 1/4	42	1.579	1.549	1.730	6F	2500	.763	1.069	1.150	8-32

“SAV-” in front of any standard timing pulley part # represents the Shaft-Saver version. Shaft-Saver pulleys have special setscrews that grip without damage to the shaft and allow easy pulley removal and realignment. For additional information, see our Shaft-Saver Engineering Section.

York also manufactures custom pulleys and complete assemblies
 email:support@york-ind.com web: www.york-ind.com



ALUMINUM WITH CLEAR ANODIZE (RoHS compliant)

FOR BELTS UP TO 15MM WIDE

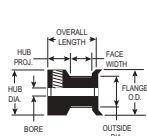

TYPE 6FC

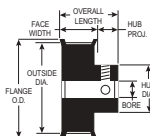

TYPE 6F

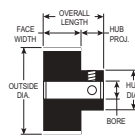

TYPE 6

PART NUMBER	NO. OF GROOVES	PITCH DIA.	OUTSIDE DIA.	FLANGE O.D.	BORE (+.001) (-.000)	FACE WIDTH	OVERALL LENGTH	HUB DIA.	SET SCREWS (2@90°)
44-3GT15-1A X 1/4	44	1.654	1.624	1.775	6F	.2500	1.069	1.250	8-32
SAV-44-3GT15-1A X 1/4	44	1.654	1.624	1.775	6F	.2500	1.069	1.250	8-32
45-3GT15-1A X 1/4	45	1.692	1.662	1.775	6F	.2500	1.069	1.250	8-32
SAV-45-3GT15-1A X 1/4	45	1.692	1.662	1.775	6F	.2500	1.069	1.250	8-32
48-3GT15-2A X 5/16	48	1.805	1.775	-	6	.3125	1.111	1.250	8-32
SAV-48-3GT15-2A X 5/16	48	1.805	1.775	-	6	.3125	1.111	1.250	8-32
50-3GT15-2A X 5/16	50	1.880	1.850	-	6	.3125	1.111	1.250	8-32
SAV-50-3GT15-2A X 5/16	50	1.880	1.850	-	6	.3125	1.111	1.250	8-32
56-3GT15-2A X 5/16	56	2.105	2.075	-	6	.3125	1.111	1.250	8-32
SAV-56-3GT15-2A X 5/16	56	2.105	2.075	-	6	.3125	1.111	1.250	8-32
60-3GT15-2A X 5/16	60	2.256	2.226	-	6	.3125	1.111	1.250	8-32
SAV-60-3GT15-2A X 5/16	60	2.256	2.226	-	6	.3125	1.111	1.250	8-32
62-3GT15-2A X 5/16	62	2.331	2.301	-	6	.3125	1.111	1.250	8-32
SAV-62-3GT15-2A X 5/16	62	2.331	2.301	-	6	.3125	1.111	1.250	8-32
68-3GT15-2A X 5/16	68	2.557	2.527	-	6	.3125	1.111	1.250	8-32
SAV-68-3GT15-2A X 5/16	68	2.557	2.527	-	6	.3125	1.111	1.250	8-32
72-3GT15-2A X 5/16	72	2.707	2.677	-	6	.3125	1.111	1.250	8-32
SAV-72-3GT15-2A X 5/16	72	2.707	2.677	-	6	.3125	1.111	1.250	8-32
74-3GT15-2A X 5/16	74	2.782	2.752	-	6	.3125	1.111	1.250	8-32
SAV-74-3GT15-2A X 5/16	74	2.782	2.752	-	6	.3125	1.111	1.250	8-32
80-3GT15-2A X 5/16	80	3.008	2.978	-	6	.3125	1.111	1.250	8-32
SAV-80-3GT15-2A X 5/16	80	3.008	2.978	-	6	.3125	1.111	1.250	8-32

“SAV-” in front of any standard timing pulley part # represents the Shaft-Saver version. Shaft-Saver pulleys have special setscrews that grip without damage to the shaft and allow easy pulley removal and realignment. For additional information, see our Shaft-Saver Engineering Section.

TIMING PULLEY STOCK

3MM GT2 PITCH

ALUMINUM 6061-T6 (RoHS compliant)

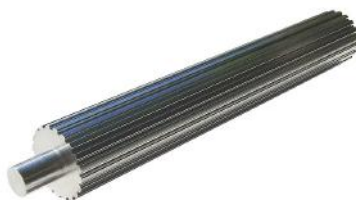
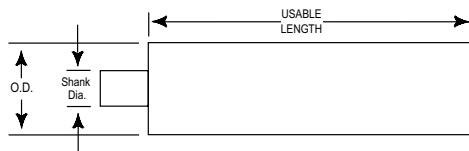

PART NUMBER	NO. OF GROOVES	PITCH DIA.	OUTSIDE DIA.	SHANK DIA.	USEABLE LENGTH
16-3GT-P-5A	16	.602	.572	1/2	5"
17-3GT-P-5A	17	.639	.609	1/2	5"
18-3GT-P-5A	18	.677	.647	1/2	5"
19-3GT-P-5A	19	.714	.684	1/2	5"
20-3GT-P-6A	20	.752	.722	1/2	6"
21-3GT-P-6A	21	.790	.760	1/2	6"
22-3GT-P-6A	22	.827	.797	1/2	6"
23-3GT-P-6A	23	.865	.835	1/2	6"
24-3GT-P-6A	24	.902	.872	1/2	6"
25-3GT-P-6A	25	.940	.910	1/2	6"
26-3GT-P-6A	26	.977	.947	1/2	6"
27-3GT-P-6A	27	1.015	.985	1/2	6"
28-3GT-P-6A	28	1.053	1.023	1/2	6"
30-3GT-P-7A	30	1.128	1.098	1/2	7"
31-3GT-P-7A	31	1.165	1.135	1/2	7"
32-3GT-P-7A	32	1.203	1.173	1/2	7"
33-3GT-P-7A	33	1.241	1.211	1/2	7"
34-3GT-P-7A	34	1.278	1.248	1/2	7"
35-3GT-P-7A	35	1.316	1.286	1/2	7"
36-3GT-P-8A	36	1.353	1.323	1/2	8"
38-3GT-P-8A	38	1.429	1.399	1/2	8"
40-3GT-P-8A	40	1.504	1.474	1/2	8"
41-3GT-P-8A	41	1.541	1.511	1/2	8"
42-3GT-P-8A	42	1.579	1.549	1/2	8"
43-3GT-P-8A	43	1.617	1.587	1/2	8"
44-3GT-P-8A	44	1.654	1.624	1/2	8"
45-3GT-P-8A	45	1.692	1.662	1/2	8"
46-3GT-P-8A	46	1.729	1.699	1/2	8"

York also manufactures custom pulleys and complete assemblies
 email: support@york-ind.com web: www.york-ind.com



ALUMINUM 6061-T6 (RoHS compliant)

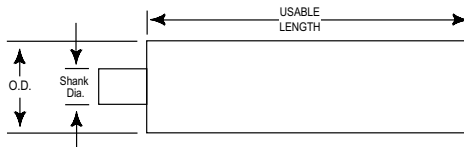

PART NUMBER	NO. OF GROOVES	PITCH DIA.	OUTSIDE DIA.	SHANK DIA.	USEABLE LENGTH
48-3GT-P-8A	48	1.805	1.775	1/2	8"
49-3GT-P-8A	49	1.842	1.812	1/2	8"
50-3GT-P-8A	50	1.880	1.850	3/4	8"
52-3GT-P-8A	52	1.955	1.925	3/4	8"
54-3GT-P-8A	54	2.030	2.000	3/4	8"
55-3GT-P-8A	55	2.068	2.038	3/4	8"
56-3GT-P-8A	56	2.105	2.075	3/4	8"
58-3GT-P-8A	58	2.181	2.151	3/4	8"
60-3GT-P-8A	60	2.256	2.226	3/4	8"
62-3GT-P-8A	62	2.331	2.301	3/4	8"
64-3GT-P-8A	64	2.406	2.376	3/4	8"
65-3GT-P-8A	65	2.444	2.414	3/4	8"
66-3GT-P-8A	66	2.481	2.451	3/4	8"
68-3GT-P-8A	68	2.557	2.527	3/4	8"
70-3GT-P-8A	70	2.632	2.602	3/4	8"
72-3GT-P-8A	72	2.707	2.677	3/4	8"
75-3GT-P-8A	75	2.820	2.790	3/4	8"
80-3GT-P-8A	80	3.008	2.978	3/4	8"
82-3GT-P-8A	82	3.083	3.053	3/4	8"
84-3GT-P-8A	84	3.158	3.128	3/4	8"
88-3GT-P-8A	88	3.308	3.278	3/4	8"
90-3GT-P-8A	90	3.384	3.354	3/4	8"
92-3GT-P-8A	92	3.459	3.429	3/4	8"
96-3GT-P-8A	96	3.609	3.579	3/4	8"
100-3GT-P-8A	100	3.760	3.730	1	8"
110-3GT-P-8A	110	4.136	4.106	1	8"
120-3GT-P-8A	120	4.511	4.481	1	8"
130-3GT-P-8A	130	4.887	4.857	1	8"
140-3GT-P-8A	140	5.263	5.233	1	8"
150-3GT-P-8A	150	5.639	5.609	1	8"
160-3GT-P-8A	160	6.015	5.985	1	8"

PULLEY FLANGES

3MM GT2 PITCH

ALUMINUM (RoHS compliant)

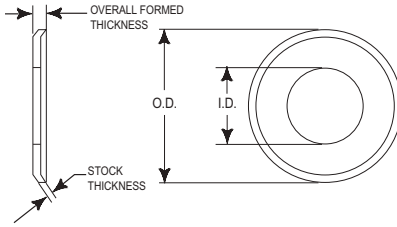

PART NUMBER	INSIDE DIA.	OUTSIDE DIA.	STOCK THICKNESS	OVERALL FORMED THICKNESS
16-3GT-F10A	.452	.710	.032	.052
17-3GT-F10A	.452	.740	.032	.052
18-3GT-F10A	.504	.790	.032	.052
19-3GT-F10A	.541	.827	.032	.052
20-3GT-F10A	.574	.895	.032	.052
22-3GT-F10A	.626	.945	.032	.052
24-3GT-F10A	.704	1.025	.032	.052
25-3GT-F10A	.738	1.060	.032	.052
26-3GT-F10A	.774	1.105	.032	.052
28-3GT-F10A	.849	1.173	.032	.052
30-3GT-F10A	.924	1.250	.032	.052
32-3GT-F10A	.999	1.323	.032	.052
34-3GT-F10A	1.074	1.398	.040	.060
36-3GT-F10A	1.149	1.478	.040	.060
38-3GT-F10A	1.225	1.549	.040	.060
40-3GT-F10A	1.300	1.625	.040	.060
42-3GT-F10A	1.356	1.730	.040	.060
44-3GT-F10A	1.450	1.775	.040	.060
45-3GT-F10A	1.450	1.775	.040	.060

York also manufactures custom pulleys and complete assemblies
 email: support@york-ind.com web: www.york-ind.com



BLACK NEOPRENE, Fiberglass Cord (RoHS compliant)

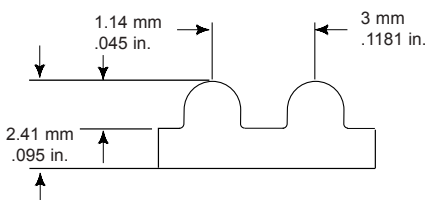

BELT NUMBER	WIDTHS				PITCH LENGTH (MM)	NO. OF TEETH
	6MM	9MM	12MM	15MM		
120-3GT	06	09	12	15	120	40
129-3GT	06	09	12	15	129	43
135-3GT	06	09	12	15	135	45
144-3GT	06	09	12	15	144	48
150-3GT	06	09	12	15	150	50
165-3GT	06	09	12	15	165	55
180-3GT	06	09	12	15	180	60
189-3GT	06	09	12	15	189	63
195-3GT	06	09	12	15	195	65
201-3GT	06	09	12	15	201	67
204-3GT	06	09	12	15	204	68
210-3GT	06	09	12	15	210	70
219-3GT	06	09	12	15	219	73
225-3GT	06	09	12	15	225	75
240-3GT	06	09	12	15	240	80
243-3GT	06	09	12	15	243	81
246-3GT	06	09	12	15	246	82
252-3GT	06	09	12	15	252	84
255-3GT	06	09	12	15	255	85
267-3GT	06	09	12	15	267	89
270-3GT	06	09	12	15	270	90
282-3GT	06	09	12	15	282	94
285-3GT	06	09	12	15	285	95
288-3GT	06	09	12	15	288	96
291-3GT	06	09	12	15	291	97
300-3GT	06	09	12	15	300	100
324-3GT	06	09	12	15	324	108
330-3GT	06	09	12	15	330	110
339-3GT	06	09	12	15	339	113
360-3GT	06	09	12	15	360	120

If you don't see the belt you need – call York!

YORK
ISO 9001: 2008 Registered

303 Nassau Blvd., Garden City Park, NY 11040

Tel: 1-800 354 8466 Fax: 1-800 354 8485

BLACK NEOPRENE, Fiberglass Cord (RoHS compliant)

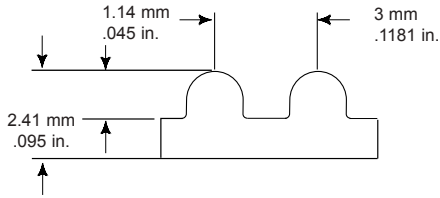

BELT NUMBER	WIDTHS				PITCH LENGTH (MM)	NO. OF TEETH
	6MM	9MM	12MM	15MM		
363-3GT	06	09	12	15	363	121
375-3GT	06	09	12	15	375	125
390-3GT	06	09	12	15	390	130
420-3GT	06	09	12	15	420	140
450-3GT	06	09	12	15	450	150
480-3GT	06	09	12	15	480	160
483-3GT	06	09	12	15	483	161
489-3GT	06	09	12	15	489	163
495-3GT	06	09	12	15	495	165
501-3GT	06	09	12	15	501	167
510-3GT	06	09	12	15	510	170
513-3GT	06	09	12	15	513	171
537-3GT	06	09	12	15	537	179
540-3GT	06	09	12	15	540	180
552-3GT	06	09	12	15	552	184
564-3GT	06	09	12	15	564	188
570-3GT	06	09	12	15	570	190
600-3GT	06	09	12	15	600	200
630-3GT	06	09	12	15	630	210
684-3GT	06	09	12	15	684	228
750-3GT	06	09	12	15	750	250
840-3GT	06	09	12	15	840	280
849-3GT	06	09	12	15	849	283
945-3GT	06	09	12	15	945	315
1050-3GT	06	09	12	15	1050	350
1536-3GT	06	09	12	15	1536	512
1587-3GT	06	09	12	15	1587	529
2061-3GT	06	09	12	15	2061	687

Need a clean, low dust belt? See TruMotion belts.

York also manufactures custom pulleys and complete assemblies
 email:support@york-ind.com web: www.york-ind.com



Cream Colored Engineered Polymer with Fiberglass Cord (RoHS compliant)

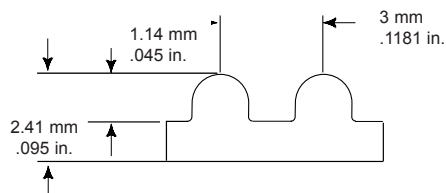
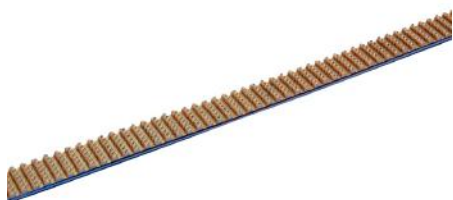

BELT NUMBER	WIDTHS				PITCH LENGTH (MM)	NO. OF TEETH
	6MM	9MM	12MM	15MM		
TM-120-3GT	06	09	12	15	120	40
TM-129-3GT	06	09	12	15	129	43
TM-135-3GT	06	09	12	15	135	45
TM-144-3GT	06	09	12	15	144	48
TM-150-3GT	06	09	12	15	150	50
TM-165-3GT	06	09	12	15	165	55
TM-180-3GT	06	09	12	15	180	60
TM-189-3GT	06	09	12	15	189	63
TM-195-3GT	06	09	12	15	195	65
TM-201-3GT	06	09	12	15	201	67
TM-204-3GT	06	09	12	15	204	68
TM-210-3GT	06	09	12	15	210	70
TM-219-3GT	06	09	12	15	219	73
TM-225-3GT	06	09	12	15	225	75
TM-240-3GT	06	09	12	15	240	80
TM-243-3GT	06	09	12	15	243	81
TM-246-3GT	06	09	12	15	246	82
TM-252-3GT	06	09	12	15	252	84
TM-255-3GT	06	09	12	15	255	85
TM-267-3GT	06	09	12	15	267	89
TM-270-3GT	06	09	12	15	270	90
TM-282-3GT	06	09	12	15	282	94
TM-285-3GT	06	09	12	15	285	95
TM-288-3GT	06	09	12	15	288	96
TM-291-3GT	06	09	12	15	291	97
TM-300-3GT	06	09	12	15	300	100
TM-324-3GT	06	09	12	15	324	108
TM-330-3GT	06	09	12	15	330	110
TM-339-3GT	06	09	12	15	339	113
TM-360-3GT	06	09	12	15	360	120

If you don't see the belt you need – call York!

Cream Colored Engineered Polymer with Fiberglass Cord (RoHS compliant)

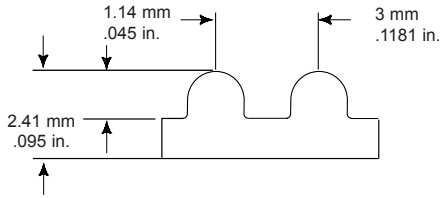

BELT NUMBER	6MM	WIDTHS			PITCH LENGTH (MM)	NO. OF TEETH
		9MM	12MM	15MM		
TM-363-3GT	06	09	12	15	363	121
TM-375-3GT	06	09	12	15	375	125
TM-390-3GT	06	09	12	15	390	130
TM-420-3GT	06	09	12	15	420	140
TM-450-3GT	06	09	12	15	450	150
TM-480-3GT	06	09	12	15	480	160
TM-483-3GT	06	09	12	15	483	161
TM-489-3GT	06	09	12	15	489	163
TM-495-3GT	06	09	12	15	495	165
TM-501-3GT	06	09	12	15	501	167
TM-510-3GT	06	09	12	15	510	170
TM-513-3GT	06	09	12	15	513	171
TM-537-3GT	06	09	12	15	537	179
TM-540-3GT	06	09	12	15	540	180
TM-552-3GT	06	09	12	15	552	184
TM-564-3GT	06	09	12	15	564	188
TM-570-3GT	06	09	12	15	570	190
TM-600-3GT	06	09	12	15	600	200
TM-630-3GT	06	09	12	15	630	210
TM-684-3GT	06	09	12	15	684	228
TM-750-3GT	06	09	12	15	750	250
TM-840-3GT	06	09	12	15	840	280
TM-849-3GT	06	09	12	15	849	283
TM-945-3GT	06	09	12	15	945	315
TM-1050-3GT	06	09	12	15	1050	350
TM-1536-3GT	06	09	12	15	1536	512
TM-1587-3GT	06	09	12	15	1587	529
TM-2061-3GT	06	09	12	15	2061	687

If you don't see the belt you need – call York!

York also manufactures custom pulleys and complete assemblies
 email:support@york-ind.com web: www.york-ind.com





(TXW) 080*

.080 (MXL)

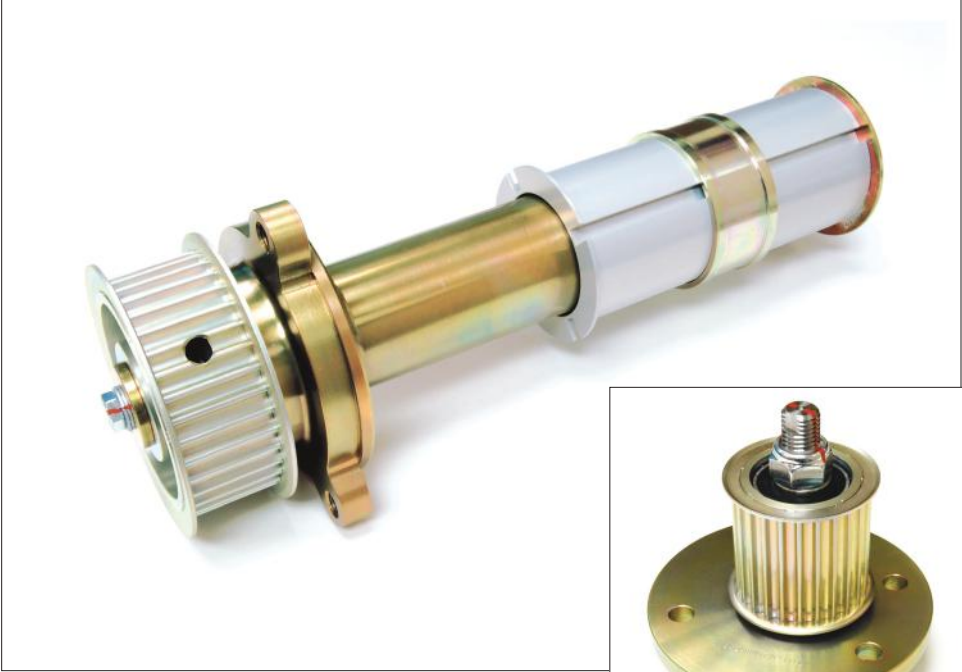

ALUMINUM WITH CLEAR ANODIZE (RoHS compliant)

FOR BELTS UP TO 1/4" WIDE

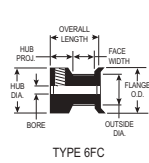

TYPE 6FC

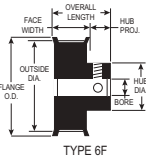

TYPE 6F

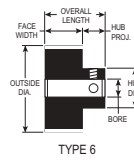

TYPE 6



PART NUMBER	NO. OF GROOVES	PITCH DIA.	OUTSIDE DIA	FLANGE O.D.	TYPE	BORE (+.001 / -.000)	FACE WIDTH	OVERALL LENGTH	HUB PROJ.	HUB DIA.	SET SCREWS
10MXL025-6A X 1/8	10	.255	.235	.425	6FC	.1250	.285	9/16	15/64	.425	4-40(1)
SAV-10MXL025-6A X 1/8	10	.255	.235	.425	6FC	.1250	.285	9/16	15/64	.425	4-40(1)
11MXL025-6A X 1/8	11	.280	.260	.450	6FC	.1250	.285	9/16	15/64	.450	4-40(1)
SAV-11MXL025-6A X 1/8	11	.280	.260	.450	6FC	.1250	.285	9/16	15/64	.450	4-40(1)
12MXL025-6A X 1/8	12	.306	.286	.480	6FC	.1250	.285	9/16	15/64	.480	4-40(1)
SAV-12MXL025-6A X 1/8	12	.306	.286	.480	6FC	.1250	.285	9/16	15/64	.480	4-40(1)
14MXL025-6A X 1/8	14	.357	.337	.530	6FC	.1250	.285	9/16	15/64	.530	4-40(1)
SAV-14MXL025-6A X 1/8	14	.357	.337	.530	6FC	.1250	.285	9/16	15/64	.530	4-40(1)
15MXL025-6A X 3/16	15	.382	.362	.555	6FC	.1875	.285	9/16	15/64	.555	6-40(1)
SAV-15MXL025-6A X 3/16	15	.382	.362	.555	6FC	.1875	.285	9/16	15/64	.555	6-40(1)
16MXL025-6A X 3/16	16	.407	.387	.580	6FC	.1875	.285	9/16	15/64	.580	6-40(1)
SAV-16MXL025-6A X 3/16	16	.407	.387	.580	6FC	.1875	.285	9/16	15/64	.580	6-40(1)
18MXL025-6A X 1/4	18	.458	.438	.635	6FC	.2500	.285	9/16	15/64	.635	6-40(2)
SAV-18MXL025-6A X 1/4	18	.458	.438	.635	6FC	.2500	.285	9/16	15/64	.635	6-40(2)
20MXL025-6A X 1/4	20	.509	.489	.685	6FC	.2500	.285	9/16	15/64	.685	6-40(2)
SAV-20MXL025-6A X 1/4	20	.509	.489	.685	6FC	.2500	.285	9/16	15/64	.685	6-40(2)
21MXL025-6A X 1/4	21	.535	.515	.710	6FC	.2500	.285	9/16	15/64	.710	6-40(2)
SAV-21MXL025-6A X 1/4	21	.535	.515	.710	6FC	.2500	.285	9/16	15/64	.710	6-40(2)
22MXL025-6A X 1/4	22	.560	.540	.740	6FC	.2500	.285	9/16	15/64	.740	6-40(2)
SAV-22MXL025-6A X 1/4	22	.560	.540	.740	6FC	.2500	.285	9/16	15/64	.740	6-40(2)
18MXL025-1A X 3/16	18	.458	.438	.635	6F	.1875	.389	5/8	15/64	.312	6-40(2)
SAV-18MXL025-1A X 3/16	18	.458	.438	.635	6F	.1875	.389	5/8	15/64	.312	6-40(2)
20MXL025-1A X 3/16	20	.509	.489	.685	6F	.1875	.389	5/8	15/64	.364	6-40(2)
SAV-20MXL025-1A X 3/16	20	.509	.489	.685	6F	.1875	.389	5/8	15/64	.364	6-40(2)
21MXL025-1A X 3/16	21	.535	.515	.710	6F	.1875	.389	5/8	15/64	.390	6-40(2)
SAV-21MXL025-1A X 3/16	21	.535	.515	.710	6F	.1875	.389	5/8	15/64	.390	6-40(2)
22MXL025-1A X 3/16	22	.560	.540	.740	6F	.1875	.389	5/8	15/64	.390	6-40(2)
SAV-22MXL025-1A X 3/16	22	.560	.540	.740	6F	.1875	.389	5/8	15/64	.390	6-40(2)
24MXL025-1A X 1/4	24	.611	.591	.790	6F	.2500	.389	11/16	19/64	.442	6-40(2)
SAV-24MXL025-1A X 1/4	24	.611	.591	.790	6F	.2500	.389	11/16	19/64	.442	6-40(2)
28MXL025-1A X 1/4	28	.713	.693	.895	6F	.2500	.389	11/16	19/64	.494	6-40(2)
SAV-28MXL025-1A X 1/4	28	.713	.693	.895	6F	.2500	.389	11/16	19/64	.494	6-40(2)
30MXL025-1A X 1/4	30	.764	.744	.945	6F	.2500	.389	11/16	19/64	.546	8-32(2)
SAV-30MXL025-1A X 1/4	30	.764	.744	.945	6F	.2500	.389	11/16	19/64	.546	8-32(2)
32MXL025-1A X 1/4	32	.815	.795	1.000	6F	.2500	.389	11/16	19/64	.598	8-32(2)
SAV-32MXL025-1A X 1/4	32	.815	.795	1.000	6F	.2500	.389	11/16	19/64	.598	8-32(2)

“SAV-” in front of any standard timing pulley part # represents the Shaft-Saver version. Shaft-Saver pulleys have special setscrews that grip without damage to the shaft and allow easy pulley removal and realignment. For additional information, see our Shaft-Saver Engineering Section.

York also manufactures custom pulleys and complete assemblies
 email:support@york-ind.com web: www.york-ind.com



ALUMINUM WITH CLEAR ANODIZE (RoHS compliant)

FOR BELTS UP TO 1/4" WIDE

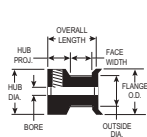

TYPE 6FC

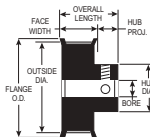

TYPE 6F

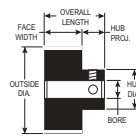

TYPE 6

PART NUMBER	NO. OF GROOVES	PITCH DIA.	OUTSIDE DIA.	FLANGE O.D.	TYPE	BORE		OVERALL LENGTH	HUB PROJ.	HUB DIA.	SET SCREWS
						(+.001)	(-.000)				
36MXL025-1A X 1/4	36	.917	.897	1.105	6F	.2500	.389	11/16	19/64	.676	8-32(2)
SAV-36MXL025-1A X 1/4	36	.917	.897	1.105	6F	.2500	.389	11/16	19/64	.676	8-32(2)
40MXL025-1A X 1/4	40	1.019	.999	1.210	6F	.2500	.405	23/32	5/16	.754	8-32(2)
SAV-40MXL025-1A X 1/4	40	1.019	.999	1.210	6F	.2500	.405	23/32	5/16	.754	8-32(2)
42MXL025-1A X 1/4	42	1.070	1.050	1.260	6F	.2500	.405	23/32	5/16	.806	8-32(2)
SAV-42MXL025-1A X 1/4	42	1.070	1.050	1.260	6F	.2500	.405	23/32	5/16	.806	8-32(2)
44MXL025-1A X 1/4	44	1.120	1.100	1.315	6F	.2500	.405	23/32	5/16	.858	8-32(2)
SAV-44MXL025-1A X 1/4	44	1.120	1.100	1.315	6F	.2500	.405	23/32	5/16	.858	8-32(2)
48MXL025-1A X 1/4	48	1.222	1.202	1.420	6F	.2500	.405	23/32	5/16	.936	8-32(2)
SAV-48MXL025-1A X 1/4	48	1.222	1.202	1.420	6F	.2500	.405	23/32	5/16	.936	8-32(2)
60MXL025-1A X 1/4	60	1.528	1.508	1.730	6F	.2500	.405	23/32	5/16	1.222	8-32(2)
SAV-60MXL025-1A X 1/4	60	1.528	1.508	1.730	6F	.2500	.405	23/32	5/16	1.222	8-32(2)
60MXL025-2A X 1/4	60	1.528	1.508	-	6	.2500	.375	3/4	3/8	1.148	8-32(2)
SAV-60MXL025-2A X 1/4	60	1.528	1.508	-	6	.2500	.375	3/4	3/8	1.148	8-32(2)
72MXL025-2A X 1/4	72	1.833	1.813	-	6	.2500	.375	3/4	3/8	1.195	8-32(2)
SAV-72MXL025-2A X 1/4	72	1.833	1.813	-	6	.2500	.375	3/4	3/8	1.195	8-32(2)
80MXL025-2A X 5/16	80	2.037	2.017	-	6	.3125	.375	3/4	3/8	1.500	8-32(2)
SAV-80MXL025-2A X 5/16	80	2.037	2.017	-	6	.3125	.375	3/4	3/8	1.500	8-32(2)
90MXL025-2A X 5/16	90	2.292	2.272	-	6	.3125	.375	3/4	3/8	1.500	8-32(2)
SAV-90MXL025-2A X 5/16	90	2.292	2.272	-	6	.3125	.375	3/4	3/8	1.500	8-32(2)
100MXL025-2A X 5/16	100	2.546	2.526	-	6	.3125	.375	3/4	3/8	1.500	8-32(2)
SAV-100MXL025-2A X 5/16	100	2.546	2.526	-	6	.3125	.375	3/4	3/8	1.500	8-32(2)
120MXL025-2A X 3/8	120	3.056	3.036	-	6	.3750	.375	3/4	3/8	1.500	10-32(2)
SAV-120MXL025-2A X 3/8	120	3.056	3.036	-	6	.3750	.375	3/4	3/8	1.500	10-32(2)

"SAV-" in front of any standard timing pulley part # represents the Shaft-Saver version. Shaft-Saver pulleys have special setscrews that grip without damage to the shaft and allow easy pulley removal and realignment. For additional information, see our Shaft-Saver Engineering Section.

ALUMINUM WITH CLEAR ANODIZE (RoHS compliant)

FOR BELTS UP TO 3/8" WIDE

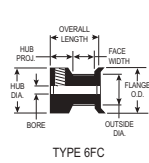

TYPE 6FC

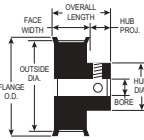

TYPE 6F

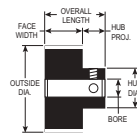

TYPE 6



PART NUMBER	NO. OF GROOVES	PITCH DIA.	OUTSIDE DIA.	FLANGE O.D.	TYPE	BORE (+.001) (-.000)	FACE WIDTH	OVERALL LENGTH	HUB PROJ.	HUB DIA.	SET SCREWS
10MXL037-6A X 1/8	10	.255	.235	.425	6FC	1250	.410	11/16	15/64	.425	4-40(1)
SAV-10MXL037-6A X 1/8	10	.255	.235	.425	6FC	1250	.410	11/16	15/64	.425	4-40(1)
11MXL037-6A X 1/8	11	.280	.260	.450	6FC	1250	.410	11/16	15/64	.450	4-40(1)
SAV-11MXL037-6A X 1/8	11	.280	.260	.450	6FC	1250	.410	11/16	15/64	.450	4-40(1)
12MXL037-6A X 1/8	12	.306	.286	.480	6FC	1250	.410	11/16	15/64	.480	4-40(1)
SAV-12MXL037-6A X 1/8	12	.306	.286	.480	6FC	1250	.410	11/16	15/64	.480	4-40(1)
14MXL037-6A X 1/8	14	.357	.337	.530	6FC	1250	.410	11/16	15/64	.530	4-40(1)
SAV-14MXL037-6A X 1/8	14	.357	.337	.530	6FC	1250	.410	11/16	15/64	.530	4-40(1)
15MXL037-6A X 3/16	15	.382	.362	.555	6FC	1875	.410	11/16	15/64	.555	6-40(1)
SAV-15MXL037-6A X 3/16	15	.382	.362	.555	6FC	1875	.410	11/16	15/64	.555	6-40(1)
16MXL037-6A X 3/16	16	.407	.387	.580	6FC	1875	.410	11/16	15/64	.580	6-40(1)
SAV-16MXL037-6A X 3/16	16	.407	.387	.580	6FC	1875	.410	11/16	15/64	.580	6-40(1)
18MXL037-6A X 1/4	18	.458	.438	.635	6FC	2500	.410	11/16	15/64	.635	6-40(2)
SAV-18MXL037-6A X 1/4	18	.458	.438	.635	6FC	2500	.410	11/16	15/64	.635	6-40(2)
20MXL037-6A X 1/4	20	.509	.489	.685	6FC	2500	.410	11/16	15/64	.685	6-40(2)
SAV-20MXL037-6A X 1/4	20	.509	.489	.685	6FC	2500	.410	11/16	15/64	.685	6-40(2)
21MXL037-6A X 1/4	21	.535	.515	.710	6FC	2500	.410	11/16	15/64	.710	6-40(2)
SAV-21MXL037-6A X 1/4	21	.535	.515	.710	6FC	2500	.410	11/16	15/64	.710	6-40(2)
22MXL037-6A X 1/4	22	.560	.540	.740	6FC	2500	.410	11/16	15/64	.740	6-40(2)
SAV-22MXL037-6A X 1/4	22	.560	.540	.740	6FC	2500	.410	11/16	15/64	.740	6-40(2)
18MXL037-1A X 3/16	18	.458	.438	.635	6F	1875	.514	3/4	15/64	.312	6-40(2)
SAV-18MXL037-1A X 3/16	18	.458	.438	.635	6F	1875	.514	3/4	15/64	.312	6-40(2)
20MXL037-1A X 3/16	20	.509	.489	.685	6F	1875	.514	3/4	15/64	.364	6-40(2)
SAV-20MXL037-1A X 3/16	20	.509	.489	.685	6F	1875	.514	3/4	15/64	.364	6-40(2)
21MXL037-1A X 3/16	21	.535	.515	.710	6F	1875	.514	3/4	15/64	.390	6-40(2)
SAV-21MXL037-1A X 3/16	21	.535	.515	.710	6F	1875	.514	3/4	15/64	.390	6-40(2)
22MXL037-1A X 3/16	22	.560	.540	.740	6F	1875	.514	3/4	15/64	.390	6-40(2)
SAV-22MXL037-1A X 3/16	22	.560	.540	.740	6F	1875	.514	3/4	15/64	.390	6-40(2)
24MXL037-1A X 1/4	24	.611	.591	.790	6F	2500	.514	13/16	19/64	.442	6-40(2)
SAV-24MXL037-1A X 1/4	24	.611	.591	.790	6F	2500	.514	13/16	19/64	.442	6-40(2)
28MXL037-1A X 1/4	28	.713	.693	.895	6F	2500	.514	13/16	19/64	.494	6-40(2)
SAV-28MXL037-1A X 1/4	28	.713	.693	.895	6F	2500	.514	13/16	19/64	.494	6-40(2)
30MXL037-1A X 1/4	30	.764	.744	.945	6F	2500	.514	13/16	19/64	.546	8-32(2)
SAV-30MXL037-1A X 1/4	30	.764	.744	.945	6F	2500	.514	13/16	19/64	.546	8-32(2)
32MXL037-1A X 1/4	32	.815	.795	1.000	6F	2500	.514	13/16	19/64	.598	8-32(2)
SAV-32MXL037-1A X 1/4	32	.815	.795	1.000	6F	2500	.514	13/16	19/64	.598	8-32(2)

"SAV-" in front of any standard timing pulley part # represents the Shaft-Saver version. Shaft-Saver pulleys have special setscrews that grip without damage to the shaft and allow easy pulley removal and realignment. For additional information, see our Shaft-Saver Engineering Section.

York also manufactures custom pulleys and complete assemblies
 email:support@york-ind.com web: www.york-ind.com



ALUMINUM WITH CLEAR ANODIZE (RoHS compliant)

FOR BELTS UP TO 3/8" WIDE

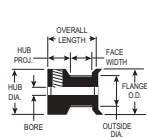

TYPE 6FC

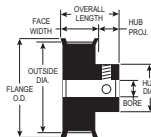

TYPE 6F

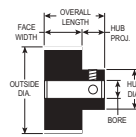

TYPE 6

PART NUMBER	NO. OF GROOVES	PITCH DIA.	OUTSIDE DIA.	FLANGE O.D.	BORE (+.001) (-.000)	FACE WIDTH	OVERALL LENGTH	HUB PROJ.	HUB DIA.	SET SCREWS	
											TYPE
36MXL037-1A X 1/4	36	.917	.897	1.105	6F	.2500	.514	13/16	19/64	.676	8-32(2)
SAV-36MXL037-1A X 1/4	36	.917	.897	1.105	6F	.2500	.514	13/16	19/64	.676	8-32(2)
40MXL037-1A X 1/4	40	1.019	.999	1.210	6F	.2500	.530	27/32	5/16	.754	8-32(2)
SAV-40MXL037-1A X 1/4	40	1.019	.999	1.210	6F	.2500	.530	27/32	5/16	.754	8-32(2)
42MXL037-1A X 1/4	42	1.070	1.050	1.260	6F	.2500	.530	27/32	5/16	.806	8-32(2)
SAV-42MXL037-1A X 1/4	42	1.070	1.050	1.260	6F	.2500	.530	27/32	5/16	.806	8-32(2)
44MXL037-1A X 1/4	44	1.120	1.100	1.315	6F	.2500	.530	27/32	5/16	.858	8-32(2)
SAV-44MXL037-1A X 1/4	44	1.120	1.100	1.315	6F	.2500	.530	27/32	5/16	.858	8-32(2)
48MXL037-1A X 1/4	48	1.222	1.202	1.420	6F	.2500	.530	27/32	5/16	.936	8-32(2)
SAV-48MXL037-1A X 1/4	48	1.222	1.202	1.420	6F	.2500	.530	27/32	5/16	.936	8-32(2)
60MXL037-1A X 1/4	60	1.528	1.508	1.730	6F	.2500	.530	27/32	5/16	1.222	8-32(2)
SAV-60MXL037-1A X 1/4	60	1.528	1.508	1.730	6F	.2500	.530	27/32	5/16	1.222	8-32(2)
60MXL037-2A X 1/4	60	1.528	1.508	-	6	.2500	.500	7/8	3/8	1.148	8-32(2)
SAV-60MXL037-2A X 1/4	60	1.528	1.508	-	6	.2500	.500	7/8	3/8	1.148	8-32(2)
72MXL037-2A X 1/4	72	1.833	1.813	-	6	.2500	.500	7/8	3/8	1.195	8-32(2)
SAV-72MXL037-2A X 1/4	72	1.833	1.813	-	6	.2500	.500	7/8	3/8	1.195	8-32(2)
80MXL037-2A X 5/16	80	2.037	2.017	-	6	.3125	.500	7/8	3/8	1.500	8-32(2)
SAV-80MXL037-2A X 5/16	80	2.037	2.017	-	6	.3125	.500	7/8	3/8	1.500	8-32(2)
90MXL037-2A X 5/16	90	2.292	2.272	-	6	.3125	.500	7/8	3/8	1.500	8-32(2)
SAV-90MXL037-2A X 5/16	90	2.292	2.272	-	6	.3125	.500	7/8	3/8	1.500	8-32(2)
100MXL037-2A X 5/16	100	2.546	2.526	-	6	.3125	.500	7/8	3/8	1.500	8-32(2)
SAV-100MXL037-2A X 5/16	100	2.546	2.526	-	6	.3125	.500	7/8	3/8	1.500	8-32(2)
120MXL037-2A X 3/8	120	3.056	3.036	-	6	.3750	.500	7/8	3/8	1.500	10-32(2)
SAV-120MXL037-2A X 3/8	120	3.056	3.036	-	6	.3750	.500	7/8	3/8	1.500	10-32(2)

"SAV-" in front of any standard timing pulley part # represents the Shaft-Saver version. Shaft-Saver pulleys have special setscrews that grip without damage to the shaft and allow easy pulley removal and realignment. For additional information, see our Shaft-Saver Engineering Section.

ALUMINUM 6061-T6 (RoHS compliant)

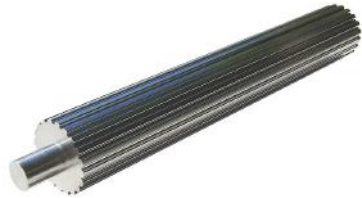
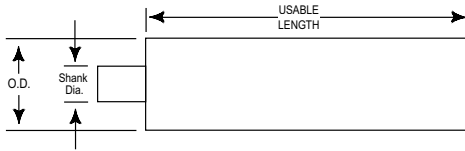

PART NUMBER	NO. OF GROOVES	PITCH DIA.	OUTSIDE DIA.	SHANK DIA.	USEABLE LENGTH
10MXL-P-2A	10	.255	.235	5/16	2"
11MXL-P-2A	11	.280	.260	5/16	2"
12MXL-P-2A	12	.306	.286	5/16	2"
13MXL-P-2A	13	.331	.311	3/8	2"
14MXL-P-3A	14	.357	.337	3/8	3"
15MXL-P-3A	15	.382	.362	7/16	3"
16MXL-P-3A	16	.407	.387	7/16	3"
17MXL-P-3A	17	.433	.413	7/16	3"
18MXL-P-3A	18	.458	.438	1/2	3"
19MXL-P-3A	19	.484	.464	1/2	3"
20MXL-P-4A	20	.509	.489	3/8	4"
21MXL-P-4A	21	.535	.515	3/8	4"
22MXL-P-4A	22	.560	.540	3/8	4"
23MXL-P-4A	23	.586	.566	3/8	4"
24MXL-P-5A	24	.611	.591	1/2	5"
25MXL-P-5A	25	.637	.617	1/2	5"
26MXL-P-5A	26	.662	.642	1/2	5"
27MXL-P-5A	27	.687	.667	1/2	5"
28MXL-P-5A	28	.713	.693	1/2	5"
29MXL-P-5A	29	.738	.718	1/2	5"
30MXL-P-6A	30	.764	.744	1/2	6"
31MXL-P-6A	31	.789	.769	1/2	6"
32MXL-P-6A	32	.815	.795	1/2	6"
33MXL-P-6A	33	.840	.820	1/2	6"
34MXL-P-6A	34	.866	.846	1/2	6"
35MXL-P-6A	35	.891	.871	1/2	6"
36MXL-P-6A	36	.917	.897	1/2	6"
37MXL-P-6A	37	.942	.922	1/2	6"
38MXL-P-6A	38	.968	.948	1/2	6"
39MXL-P-6A	39	.993	.973	1/2	6"

York also manufactures custom pulleys and complete assemblies
 email:support@york-ind.com web: www.york-ind.com



ALUMINUM 6061-T6 (RoHS compliant)

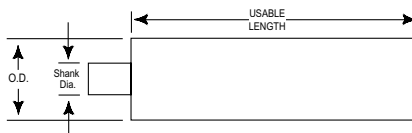
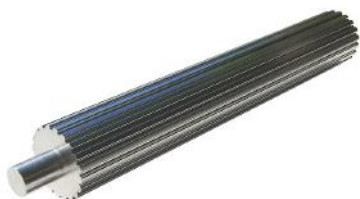

PART NUMBER	NO. OF GROOVES	PITCH DIA.	OUTSIDE DIA.	SHANK DIA.	USEABLE LENGTH
40MXL-P-7A	40	1.019	.999	1/2	7"
42MXL-P-7A	42	1.070	1.050	1/2	7"
44MXL-P-7A	44	1.120	1.100	1/2	7"
45MXL-P-7A	45	1.146	1.126	1/2	7"
48MXL-P-7A	48	1.222	1.202	1/2	7"
50MXL-P-7A	50	1.273	1.253	1/2	7"
51MXL-P-7A	51	1.299	1.279	1/2	7"
52MXL-P-7A	52	1.324	1.304	1/2	7"
54MXL-P-7A	54	1.375	1.355	1/2	7"
55MXL-P-7A	55	1.401	1.381	1/2	7"
56MXL-P-7A	56	1.426	1.406	1/2	7"
57MXL-P-7A	57	1.451	1.431	1/2	7"
60MXL-P-8A	60	1.528	1.508	1/2	8"
64MXL-P-8A	64	1.630	1.610	1/2	8"
65MXL-P-8A	65	1.655	1.635	1/2	8"
66MXL-P-8A	66	1.681	1.661	1/2	8"
70MXL-P-8A	70	1.783	1.763	1/2	8"
72MXL-P-8A	72	1.833	1.813	1/2	8"
75MXL-P-8A	75	1.910	1.890	1/2	8"
80MXL-P-8A	80	2.037	2.017	3/4	8"
82MXL-P-8A	82	2.088	2.068	3/4	8"
84MXL-P-8A	84	2.139	2.119	3/4	8"
88MXL-P-8A	88	2.241	2.221	3/4	8"
90MXL-P-8A	90	2.292	2.272	3/4	8"
96MXL-P-8A	96	2.445	2.425	3/4	8"
98MXL-P-8A	98	2.496	2.476	3/4	8"
100MXL-P-8A	100	2.546	2.526	3/4	8"
102MXL-P-8A	102	2.597	2.577	3/4	8"
108MXL-P-8A	108	2.750	2.730	3/4	8"
110MXL-P-8A	110	2.801	2.781	3/4	8"
120MXL-P-8A	120	3.056	3.036	3/4	8"
130MXL-P-8A	130	3.310	3.290	3/4	8"
140MXL-P-8A	140	3.565	3.545	3/4	8"
150MXL-P-8A	150	3.820	3.800	3/4	8"

YORK

ISO 9001: 2008 Registered

303 Nassau Blvd., Garden City Park, NY 11040

Tel: 1-800 354 8466 Fax: 1-800 354 8485

PULLEY FLANGES

.080" PITCH

41

ALUMINUM (RoHS compliant)

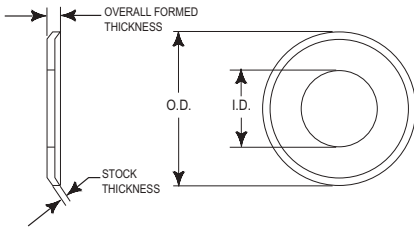

PART NUMBER	INSIDE DIA.	OUTSIDE DIA.	STOCK THICKNESS	OVERALL FORMED THICKNESS
10M-F1A	.188	.425	.025	.045
11M-F1A	.214	.450	.025	.045
12M-F1A	.218	.480	.025	.045
13M-F1A	.244	.505	.025	.045
14M-F1A	.270	.530	.025	.045
15M-F1A	.296	.555	.025	.045
16M-F1A	.322	.580	.025	.045
18M-F1A	.374	.635	.032	.052
20M-F1A	.426	.685	.032	.052
21M-F1A	.452	.710	.032	.052
22M-F1A	.452	.740	.032	.052
24M-F1A	.504	.790	.032	.052
25M-F1A	.530	.815	.032	.052
26M-F1A	.556	.840	.032	.052
28M-F1A	.574	.895	.032	.052
30M-F1A	.626	.945	.032	.052
32M-F1A	.678	1.000	.032	.052
33M-F1A	.704	1.025	.032	.052
34M-F1A	.722	1.050	.032	.052
35M-F1A	.748	1.080	.032	.052
36M-F1A	.774	1.105	.032	.052
38M-F1A	.826	1.155	.032	.052
40M-F1A	.874	1.210	.040	.060
42M-F1A	.926	1.260	.040	.060
44M-F1A	.978	1.315	.040	.060
45M-F1A	1.004	1.340	.040	.060
48M-F1A	1.058	1.420	.040	.060
50M-F1A	1.110	1.470	.040	.060
54M-F1A	1.200	1.575	.040	.060
60M-F1A	1.356	1.730	.040	.060

York also manufactures custom pulleys and complete assemblies
 email: support@york-ind.com web: www.york-ind.com



BLACK NEOPRENE, Fiberglass Cord (RoHS compliant)

If you don't see the belt you need – call York!

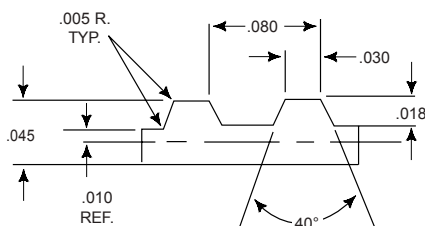

BELT NUMBER	1/8"	WIDTHS 3/16"		1/4"	PITCH LENGTH	NO. OF TEETH	BELT NUMBER	1/8"	WIDTHS 3/16"		1/4"	PITCH LENGTH	NO. OF TEETH
29MXL	012	019	025		2.88	36	70MXL	012	019	025		7.04	88
32MXL	012	019	025		3.20	40	72MXL	012	019	025		7.20	90
34MXL	012	019	025		3.36	42	73MXL	012	019	025		7.36	92
36MXL	012	019	025		3.60	45	74MXL	012	019	025		7.44	93
40MXL	012	019	025		4.00	50	75MXL	012	019	025		7.52	94
42MXL	012	019	025		4.24	53	76MXL	012	019	025		7.60	95
43MXL	012	019	025		4.30	54	78MXL	012	019	025		7.76	97
44MXL	012	019	025		4.40	55	80MXL	012	019	025		8.00	100
45MXL	012	019	025		4.48	56	81MXL	012	019	025		8.08	101
46MXL	012	019	025		4.64	58	82MXL	012	019	025		8.16	102
47MXL	012	019	025		4.72	59	84MXL	012	019	025		8.40	105
48MXL	012	019	025		4.80	60	85MXL	012	019	025		8.48	106
49MXL	012	019	025		4.88	61	86MXL	012	019	025		8.56	107
50MXL	012	019	025		5.04	63	87MXL	012	019	025		8.72	109
51MXL	012	019	025		5.12	64	88MXL	012	019	025		8.80	110
52MXL	012	019	025		5.20	65	90MXL	012	019	025		8.96	112
53MXL	012	019	025		5.36	67	91MXL	012	019	025		9.12	114
54MXL	012	019	025		5.44	68	94MXL	012	019	025		9.44	118
55MXL	012	019	025		5.52	69	96MXL	012	019	025		9.60	120
56MXL	012	019	025		5.60	70	97MXL	012	019	025		9.76	122
57MXL	012	019	025		5.68	71	98MXL	012	019	025		9.84	123
58MXL-U	012	019	025		5.76	72	100MXL	012	019	025		10.00	125
58MXL-D	012	019	025		5.84	73	101MXL	012	019	025		10.08	126
60MXL	012	019	025		6.00	75	102MXL	012	019	025		10.16	127
61MXL	012	019	025		6.08	76	103MXL	012	019	025		10.32	129
62MXL	012	019	025		6.16	77	104MXL	012	019	025		10.40	130
63MXL	012	019	025		6.32	79	106MXL	012	019	025		10.56	132
64MXL	012	019	025		6.40	80	107MXL	012	019	025		10.72	134
64MXL-D	012	019	025		6.48	81	111MXL	012	019	025		11.12	139
65MXL	012	019	025		6.56	82	112MXL	012	019	025		11.20	140
66MXL	012	019	025		6.64	83	115MXL	012	019	025		11.52	144
67MXL	012	019	025		6.72	84	116MXL	012	019	025		11.60	145
68MXL	012	019	025		6.80	85	120MXL	012	019	025		12.00	150
69MXL	012	019	025		6.96	87	122MXL	012	019	025		12.24	153

YORK

ISO 9001: 2008 Registered

303 Nassau Blvd., Garden City Park, NY 11040

Tel: 1-800 354 8466 Fax: 1-800 354 8485

BLACK NEOPRENE, Fiberglass Cord (RoHS compliant)

Need a clean, low dust belt? See TruMotion belts

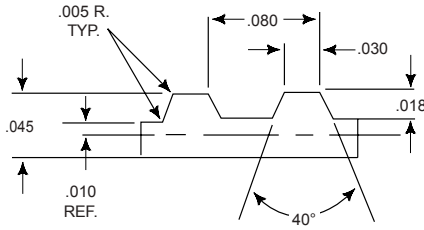

BELT NUMBER	1/8"	WIDTHS 3/16"	1/4"	PITCH LENGTH	NO. OF TEETH	BELT NUMBER	1/8"	WIDTHS 3/16"	1/4"	PITCH LENGTH	NO. OF TEETH
124MXL	012	019	025	12.40	155	240MXL	012	019	025	24.00	300
126MXL	012	019	025	12.64	158	252MXL	012	019	025	25.20	315
128MXL	012	019	025	12.80	160	254MXL	012	019	025	25.44	318
132MXL	012	019	025	13.20	165	274MXL	012	019	025	27.44	343
133MXL	012	019	025	13.28	166	277MXL	012	019	025	27.76	347
136MXL	012	019	025	13.60	170	286MXL	012	019	025	28.64	358
140MXL	012	019	025	14.00	175	288MXL	012	019	025	28.80	360
144MXL	012	019	025	14.40	180	297MXL	012	019	025	29.68	371
147MXL	012	019	025	14.72	184	298MXL	012	019	025	29.76	372
152MXL	012	019	025	15.20	190	312MXL	012	019	025	31.20	390
156MXL	012	019	025	15.60	195	320MXL	012	019	025	32.00	400
160MXL	012	019	025	16.00	200	326MXL	012	019	025	32.64	408
166MXL	012	019	025	16.64	208	330MXL	012	019	025	32.96	412
168MXL	012	019	025	16.80	210	336MXL	012	019	025	33.60	420
170MXL	012	019	025	16.96	212	339MXL	012	019	025	33.92	424
177MXL	012	019	025	17.68	221	340MXL	012	019	025	34.00	425
178MXL	012	019	025	17.76	222	345MXL	012	019	025	34.48	431
180MXL	012	019	025	18.00	225	347MXL	012	019	025	34.72	434
183MXL	012	019	025	18.32	229	348MXL	012	019	025	34.80	435
184MXL	012	019	025	18.40	230	352MXL	012	019	025	35.20	440
186MXL	012	019	025	18.56	232	362MXL	012	019	025	36.24	453
188MXL	012	019	025	18.80	235	370MXL	012	019	025	37.04	463
196MXL	012	019	025	19.60	245	380MXL	012	019	025	38.00	475
198MXL	012	019	025	19.84	248	389MXL	012	019	025	38.96	487
199MXL	012	019	025	19.92	249	390MXL	012	019	025	39.04	488
200MXL	012	019	025	20.00	250	398MXL	012	019	025	39.84	498
201MXL	012	019	025	20.08	251	400MXL	012	019	025	40.00	500
205MXL	012	019	025	20.48	256	404MXL	012	019	025	40.40	505
208MXL	012	019	025	20.80	260	426MXL	012	019	025	42.56	532
212MXL	012	019	025	21.20	265	437MXL	012	019	025	43.68	546
214MXL	012	019	025	21.36	267	474MXL	012	019	025	47.36	592
224MXL	012	019	025	22.40	280	480MXL	012	019	025	48.00	600
236MXL	012	019	025	23.60	295	490MXL	012	019	025	48.96	612
238MXL	012	019	025	23.84	298	518MXL	012	019	025	51.84	648

York also manufactures custom pulleys and complete assemblies
 email: support@york-ind.com web: www.york-ind.com



URETHANE, Polyester Cord (RoHS compliant)

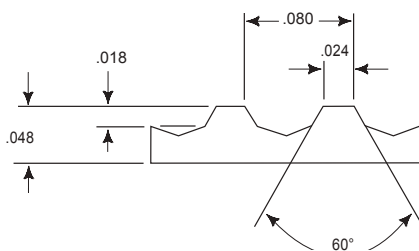

BELT NUMBER	1/8"	WIDTHS 3/16"	1/4"	PITCH LENGTH	NO. OF TEETH	BELT NUMBER	1/8"	WIDTHS 3/16"	1/4"	PITCH LENGTH	NO. OF TEETH
30T80-P	1/8	3/16	1/4	2.400	30	88T80-P	1/8	3/16	1/4	7.040	88
35T80-P	1/8	3/16	1/4	2.800	35	89T80-P	1/8	3/16	1/4	7.120	89
36T80-P	1/8	3/16	1/4	2.880	36	90T80-P	1/8	3/16	1/4	7.200	90
40T80-P	1/8	3/16	1/4	3.200	40	91T80-P	1/8	3/16	1/4	7.280	91
45T80-P	1/8	3/16	1/4	3.600	45	93T80-P	1/8	3/16	1/4	7.440	93
46T80-P	1/8	3/16	1/4	3.680	46	94T80-P	1/8	3/16	1/4	7.520	94
48T80-P	1/8	3/16	1/4	3.840	48	95T80-P	1/8	3/16	1/4	7.600	95
50T80-P	1/8	3/16	1/4	4.000	50	97T80-P	1/8	3/16	1/4	7.760	97
51T80-P	1/8	3/16	1/4	4.080	51	100T80-P	1/8	3/16	1/4	8.000	100
52T80-P	1/8	3/16	1/4	4.160	52	102T80-P	1/8	3/16	1/4	8.160	102
54T80-P	1/8	3/16	1/4	4.320	54	103T80-P	1/8	3/16	1/4	8.240	103
55T80-P	1/8	3/16	1/4	4.400	55	105T80-P	1/8	3/16	1/4	8.400	105
56T80-P	1/8	3/16	1/4	4.480	56	106T80-P	1/8	3/16	1/4	8.480	106
59T80-P	1/8	3/16	1/4	4.720	59	110T80-P	1/8	3/16	1/4	8.800	110
60T80-P	1/8	3/16	1/4	4.800	60	112T80-P	1/8	3/16	1/4	8.960	112
61T80-P	1/8	3/16	1/4	4.880	61	114T80-P	1/8	3/16	1/4	9.120	114
62T80-P	1/8	3/16	1/4	4.960	62	115T80-P	1/8	3/16	1/4	9.200	115
64T80-P	1/8	3/16	1/4	5.120	64	118T80-P	1/8	3/16	1/4	9.440	118
65T80-P	1/8	3/16	1/4	5.200	65	120T80-P	1/8	3/16	1/4	9.600	120
68T80-P	1/8	3/16	1/4	5.440	68	122T80-P	1/8	3/16	1/4	9.760	122
70T80-P	1/8	3/16	1/4	5.600	70	123T80-P	1/8	3/16	1/4	9.840	123
71T80-P	1/8	3/16	1/4	5.680	71	125T80-P	1/8	3/16	1/4	10.000	125
72T80-P	1/8	3/16	1/4	5.760	72	126T80-P	1/8	3/16	1/4	10.080	126
73T80-P	1/8	3/16	1/4	5.840	73	130T80-P	1/8	3/16	1/4	10.400	130
75T80-P	1/8	3/16	1/4	6.000	75	132T80-P	1/8	3/16	1/4	10.560	132
78T80-P	1/8	3/16	1/4	6.240	78	135T80-P	1/8	3/16	1/4	10.800	135
79T80-P	1/8	3/16	1/4	6.320	79	140T80-P	1/8	3/16	1/4	11.200	140
80T80-P	1/8	3/16	1/4	6.400	80	144T80-P	1/8	3/16	1/4	11.520	144
82T80-P	1/8	3/16	1/4	6.560	82	145T80-P	1/8	3/16	1/4	11.600	145
83T80-P	1/8	3/16	1/4	6.640	83	150T80-P	1/8	3/16	1/4	12.000	150
85T80-P	1/8	3/16	1/4	6.800	85	155T80-P	1/8	3/16	1/4	12.400	155
87T80-P	1/8	3/16	1/4	6.960	87	156T80-P	1/8	3/16	1/4	12.480	156

If you don't see the belt you need – call York!

YORK

ISO 9001: 2008 Registered

303 Nassau Blvd., Garden City Park, NY 11040

Tel: 1-800 354 8466 Fax: 1-800 354 8485

TIMING BELTS

.080" PITCH

45

URETHANE, Polyester Cord (RoHS compliant)

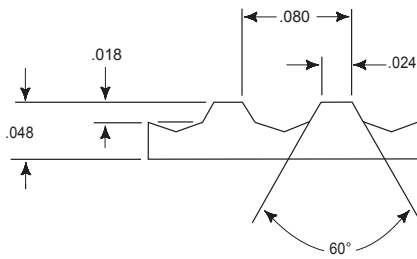

BELT NUMBER	1/8"	WIDTHS 3/16"	1/4"	PITCH LENGTH	NO. OF TEETH	BELT NUMBER	1/8"	WIDTHS 3/16"	1/4"	PITCH LENGTH	NO. OF TEETH
160T80-P	1/8	3/16	1/4	12.800	160	280T80-P	1/8	3/16	1/4	22.400	280
165T80-P	1/8	3/16	1/4	13.200	165	285T80-P	1/8	3/16	1/4	22.800	285
170T80-P	1/8	3/16	1/4	13.600	170	290T80-P	1/8	3/16	1/4	23.200	290
175T80-P	1/8	3/16	1/4	14.000	175	300T80-P	1/8	3/16	1/4	24.000	300
180T80-P	1/8	3/16	1/4	14.400	180	310T80-P	1/8	3/16	1/4	24.800	310
184T80-P	1/8	3/16	1/4	14.720	184	315T80-P	1/8	3/16	1/4	25.200	315
185T80-P	1/8	3/16	1/4	14.800	185	320T80-P	1/8	3/16	1/4	25.600	320
190T80-P	1/8	3/16	1/4	15.200	190	324T80-P	1/8	3/16	1/4	25.920	324
195T80-P	1/8	3/16	1/4	15.600	195	330T80-P	1/8	3/16	1/4	26.400	330
200T80-P	1/8	3/16	1/4	16.000	200	336T80-P	1/8	3/16	1/4	26.880	336
205T80-P	1/8	3/16	1/4	16.400	205	340T80-P	1/8	3/16	1/4	27.200	340
210T80-P	1/8	3/16	1/4	16.800	210	350T80-P	1/8	3/16	1/4	28.000	350
212T80-P	1/8	3/16	1/4	16.960	212	360T80-P	1/8	3/16	1/4	28.800	360
215T80-P	1/8	3/16	1/4	17.200	215	370T80-P	1/8	3/16	1/4	29.600	370
220T80-P	1/8	3/16	1/4	17.600	220	380T80-P	1/8	3/16	1/4	30.400	380
224T80-P	1/8	3/16	1/4	17.920	224	390T80-P	1/8	3/16	1/4	31.200	390
225T80-P	1/8	3/16	1/4	18.000	225	400T80-P	1/8	3/16	1/4	32.000	400
230T80-P	1/8	3/16	1/4	18.400	230	403T80-P	1/8	3/16	1/4	32.240	403
232T80-P	1/8	3/16	1/4	18.560	232	420T80-P	1/8	3/16	1/4	33.600	420
235T80-P	1/8	3/16	1/4	18.800	235	434T80-P	1/8	3/16	1/4	34.720	434
236T80-P	1/8	3/16	1/4	18.880	236	454T80-P	1/8	3/16	1/4	36.320	454
240T80-P	1/8	3/16	1/4	19.200	240	481T80-P	1/8	3/16	1/4	38.480	481
245T80-P	1/8	3/16	1/4	19.600	245	482T80-P	1/8	3/16	1/4	38.560	482
249T80-P	1/8	3/16	1/4	19.920	249	515T80-P	1/8	3/16	1/4	41.200	515
250T80-P	1/8	3/16	1/4	20.000	250	562T80-P	1/8	3/16	1/4	44.960	562
253T80-P	1/8	3/16	1/4	20.240	253	601T80-P	1/8	3/16	1/4	48.080	601
255T80-P	1/8	3/16	1/4	20.400	255	962T80-P	1/8	3/16	1/4	76.960	962
260T80-P	1/8	3/16	1/4	20.800	260	979T80-P	1/8	3/16	1/4	78.320	979
265T80-P	1/8	3/16	1/4	21.200	265	1155T80-P	1/8	3/16	1/4	92.400	1155
270T80-P	1/8	3/16	1/4	21.600	270	1250T80-P	1/8	3/16	1/4	100.000	1250
275T80-P	1/8	3/16	1/4	22.000	275	1300T80-P	1/8	3/16	1/4	104.000	1300

If you don't see the belt you need – call York!

York also manufactures custom pulleys and complete assemblies
 email: support@york-ind.com web: www.york-ind.com



URETHANE, Kevlar Cord (RoHS compliant)

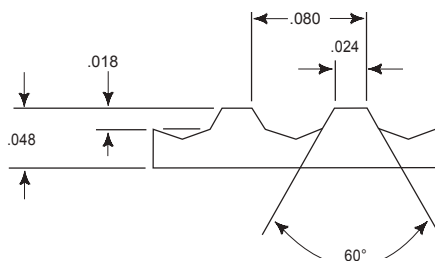

BELT NUMBER	1/8"	WIDTHS 3/16"	1/4"	PITCH LENGTH	NO. OF TEETH	BELT NUMBER	1/8"	WIDTHS 3/16"	1/4"	PITCH LENGTH	NO. OF TEETH
30T80-K	1/8	3/16	1/4	2.400	30	88T80-K	1/8	3/16	1/4	7.040	88
35T80-K	1/8	3/16	1/4	2.800	35	89T80-K	1/8	3/16	1/4	7.120	89
36T80-K	1/8	3/16	1/4	2.880	36	90T80-K	1/8	3/16	1/4	7.200	90
40T80-K	1/8	3/16	1/4	3.200	40	91T80-K	1/8	3/16	1/4	7.280	91
45T80-K	1/8	3/16	1/4	3.600	45	93T80-K	1/8	3/16	1/4	7.440	93
46T80-K	1/8	3/16	1/4	3.680	46	94T80-K	1/8	3/16	1/4	7.520	94
48T80-K	1/8	3/16	1/4	3.840	48	95T80-K	1/8	3/16	1/4	7.600	95
50T80-K	1/8	3/16	1/4	4.000	50	97T80-K	1/8	3/16	1/4	7.760	97
51T80-K	1/8	3/16	1/4	4.080	51	100T80-K	1/8	3/16	1/4	8.000	100
52T80-K	1/8	3/16	1/4	4.160	52	102T80-K	1/8	3/16	1/4	8.160	102
54T80-K	1/8	3/16	1/4	4.320	54	103T80-K	1/8	3/16	1/4	8.240	103
55T80-K	1/8	3/16	1/4	4.400	55	105T80-K	1/8	3/16	1/4	8.400	105
56T80-K	1/8	3/16	1/4	4.480	56	106T80-K	1/8	3/16	1/4	8.480	106
59T80-K	1/8	3/16	1/4	4.720	59	110T80-K	1/8	3/16	1/4	8.800	110
60T80-K	1/8	3/16	1/4	4.800	60	112T80-K	1/8	3/16	1/4	8.960	112
61T80-K	1/8	3/16	1/4	4.880	61	114T80-K	1/8	3/16	1/4	9.120	114
62T80-K	1/8	3/16	1/4	4.960	62	115T80-K	1/8	3/16	1/4	9.200	115
64T80-K	1/8	3/16	1/4	5.120	64	118T80-K	1/8	3/16	1/4	9.440	118
65T80-K	1/8	3/16	1/4	5.200	65	120T80-K	1/8	3/16	1/4	9.600	120
68T80-K	1/8	3/16	1/4	5.440	68	122T80-K	1/8	3/16	1/4	9.760	122
70T80-K	1/8	3/16	1/4	5.600	70	123T80-K	1/8	3/16	1/4	9.840	123
71T80-K	1/8	3/16	1/4	5.680	71	125T80-K	1/8	3/16	1/4	10.000	125
72T80-K	1/8	3/16	1/4	5.760	72	126T80-K	1/8	3/16	1/4	10.080	126
73T80-K	1/8	3/16	1/4	5.840	73	130T80-K	1/8	3/16	1/4	10.400	130
75T80-K	1/8	3/16	1/4	6.000	75	132T80-K	1/8	3/16	1/4	10.560	132
78T80-K	1/8	3/16	1/4	6.240	78	135T80-K	1/8	3/16	1/4	10.800	135
79T80-K	1/8	3/16	1/4	6.320	79	140T80-K	1/8	3/16	1/4	11.200	140
80T80-K	1/8	3/16	1/4	6.400	80	144T80-K	1/8	3/16	1/4	11.520	144
82T80-K	1/8	3/16	1/4	6.560	82	145T80-K	1/8	3/16	1/4	11.600	145
83T80-K	1/8	3/16	1/4	6.640	83	150T80-K	1/8	3/16	1/4	12.000	150
85T80-K	1/8	3/16	1/4	6.800	85	155T80-K	1/8	3/16	1/4	12.400	155
87T80-K	1/8	3/16	1/4	6.960	87	156T80-K	1/8	3/16	1/4	12.480	156

If you don't see the belt you need – call York!

YORK
ISO 9001: 2008 Registered

303 Nassau Blvd., Garden City Park, NY 11040

Tel: 1-800 354 8466 Fax: 1-800 354 8485

TIMING BELTS

.080" PITCH

4.7

URETHANE, Kevlar Cord (RoHS compliant)

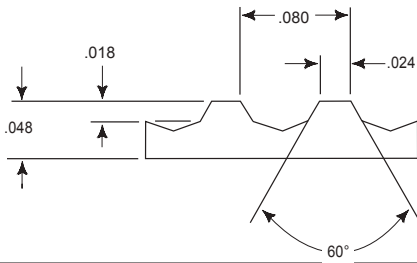

BELT NUMBER	1/8"	WIDTHS 3/16"	1/4"	PITCH LENGTH	NO. OF TEETH	BELT NUMBER	1/8"	WIDTHS 3/16"	1/4"	PITCH LENGTH	NO. OF TEETH
160T80-K	1/8	3/16	1/4	12.800	160	285T80-K	1/8	3/16	1/4	22.800	285
165T80-K	1/8	3/16	1/4	13.200	165	290T80-K	1/8	3/16	1/4	23.200	290
170T80-K	1/8	3/16	1/4	13.600	170	295T80-K	1/8	3/16	1/4	23.600	295
175T80-K	1/8	3/16	1/4	14.000	175	300T80-K	1/8	3/16	1/4	24.000	300
180T80-K	1/8	3/16	1/4	14.400	180	310T80-K	1/8	3/16	1/4	24.800	310
184T80-K	1/8	3/16	1/4	14.720	184	315T80-K	1/8	3/16	1/4	25.200	315
185T80-K	1/8	3/16	1/4	14.800	185	320T80-K	1/8	3/16	1/4	25.600	320
190T80-K	1/8	3/16	1/4	15.200	190	324T80-K	1/8	3/16	1/4	25.920	324
195T80-K	1/8	3/16	1/4	15.600	195	330T80-K	1/8	3/16	1/4	26.400	330
200T80-K	1/8	3/16	1/4	16.000	200	336T80-K	1/8	3/16	1/4	26.880	336
205T80-K	1/8	3/16	1/4	16.400	205	340T80-K	1/8	3/16	1/4	27.200	340
210T80-K	1/8	3/16	1/4	16.800	210	350T80-K	1/8	3/16	1/4	28.000	350
212T80-K	1/8	3/16	1/4	16.960	212	358T80-K	1/8	3/16	1/4	28.640	358
215T80-K	1/8	3/16	1/4	17.200	215	360T80-K	1/8	3/16	1/4	28.800	360
220T80-K	1/8	3/16	1/4	17.600	220	370T80-K	1/8	3/16	1/4	29.600	370
224T80-K	1/8	3/16	1/4	17.920	224	380T80-K	1/8	3/16	1/4	30.400	380
225T80-K	1/8	3/16	1/4	18.000	225	390T80-K	1/8	3/16	1/4	31.200	390
230T80-K	1/8	3/16	1/4	18.400	230	400T80-K	1/8	3/16	1/4	32.000	400
232T80-K	1/8	3/16	1/4	18.560	232	403T80-K	1/8	3/16	1/4	32.240	403
235T80-K	1/8	3/16	1/4	18.800	235	420T80-K	1/8	3/16	1/4	33.600	420
236T80-K	1/8	3/16	1/4	18.880	236	434T80-K	1/8	3/16	1/4	34.720	434
240T80-K	1/8	3/16	1/4	19.200	240	454T80-K	1/8	3/16	1/4	36.320	454
245T80-K	1/8	3/16	1/4	19.600	245	481T80-K	1/8	3/16	1/4	38.480	481
249T80-K	1/8	3/16	1/4	19.920	249	482T80-K	1/8	3/16	1/4	38.560	482
250T80-K	1/8	3/16	1/4	20.000	250	515T80-K	1/8	3/16	1/4	41.200	515
253T80-K	1/8	3/16	1/4	20.240	253	562T80-K	1/8	3/16	1/4	44.960	562
255T80-K	1/8	3/16	1/4	20.400	255	601T80-K	1/8	3/16	1/4	48.080	601
260T80-K	1/8	3/16	1/4	20.800	260	962T80-K	1/8	3/16	1/4	76.960	962
265T80-K	1/8	3/16	1/4	21.200	265	979T80-K	1/8	3/16	1/4	78.320	979
270T80-K	1/8	3/16	1/4	21.600	270	1155T80-K	1/8	3/16	1/4	92.400	1155
275T80-K	1/8	3/16	1/4	22.000	275	1250T80-K	1/8	3/16	1/4	100.000	1250
280T80-K	1/8	3/16	1/4	22.400	280	1300T80-K	1/8	3/16	1/4	104.000	1300

If you don't see the belt you need – call York!

York also manufactures custom pulleys and complete assemblies
 email: support@york-ind.com web: www.york-ind.com



Cream Colored Engineered Polymer with Fiberglass Cord (RoHS compliant)

If you don't see the belt you need – call York!

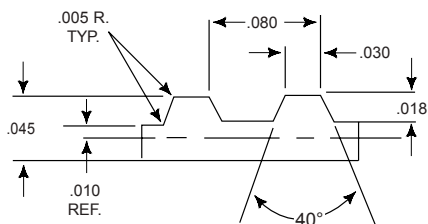

BELT NUMBER	1/8"	WIDTHS 3/16"	1/4"	PITCH LENGTH	NO. OF TEETH	BELT NUMBER	1/8"	WIDTHS 3/16"	1/4"	PITCH LENGTH	NO. OF TEETH
TM-29MXL	012	019	025	2.88	36	TM-70MXL	012	019	025	7.04	88
TM-32MXL	012	019	025	3.20	40	TM-72MXL	012	019	025	7.20	90
TM-34MXL	012	019	025	3.36	42	TM-73MXL	012	019	025	7.36	92
TM-36MXL	012	019	025	3.60	45	TM-74MXL	012	019	025	7.44	93
TM-40MXL	012	019	025	4.00	50	TM-75MXL	012	019	025	7.52	94
TM-42MXL	012	019	025	4.24	53	TM-76MXL	012	019	025	7.60	95
TM-43MXL	012	019	025	4.30	54	TM-78MXL	012	019	025	7.76	97
TM-44MXL	012	019	025	4.40	55	TM-80MXL	012	019	025	8.00	100
TM-45MXL	012	019	025	4.48	56	TM-81MXL	012	019	025	8.08	101
TM-46MXL	012	019	025	4.64	58	TM-82MXL	012	019	025	8.16	102
TM-47MXL	012	019	025	4.72	59	TM-84MXL	012	019	025	8.40	105
TM-48MXL	012	019	025	4.80	60	TM-85MXL	012	019	025	8.48	106
TM-49MXL	012	019	025	4.88	61	TM-86MXL	012	019	025	8.56	107
TM-50MXL	012	019	025	5.04	63	TM-87MXL	012	019	025	8.72	109
TM-51MXL	012	019	025	5.12	64	TM-88MXL	012	019	025	8.80	110
TM-52MXL	012	019	025	5.20	65	TM-90MXL	012	019	025	8.96	112
TM-53MXL	012	019	025	5.36	67	TM-91MXL	012	019	025	9.12	114
TM-54MXL	012	019	025	5.44	68	TM-94MXL	012	019	025	9.44	118
TM-55MXL	012	019	025	5.52	69	TM-96MXL	012	019	025	9.60	120
TM-56MXL	012	019	025	5.60	70	TM-97MXL	012	019	025	9.76	122
TM-57MXL	012	019	025	5.68	71	TM-98MXL	012	019	025	9.84	123
TM-58MXL-D	012	019	025	5.76	72	TM-100MXL	012	019	025	10.00	125
TM-58MXL-U	012	019	025	5.84	73	TM-101MXL	012	019	025	10.08	126
TM-60MXL	012	019	025	6.00	75	TM-102MXL	012	019	025	10.16	127
TM-61MXL	012	019	025	6.08	76	TM-103MXL	012	019	025	10.32	129
TM-62MXL	012	019	025	6.16	77	TM-104MXL	012	019	025	10.40	130
TM-63MXL	012	019	025	6.32	79	TM-106MXL	012	019	025	10.56	132
TM-64MXL	012	019	025	6.40	80	TM-107MXL	012	019	025	10.72	134
TM-64MXL-D	012	019	025	6.48	81	TM-111MXL	012	019	025	11.12	139
TM-65MXL	012	019	025	6.56	82	TM-112MXL	012	019	025	11.20	140
TM-66MXL	012	019	025	6.64	83	TM-115MXL	012	019	025	11.52	144
TM-67MXL	012	019	025	6.72	84	TM-116MXL	012	019	025	11.60	145
TM-68MXL	012	019	025	6.80	85	TM-120MXL	012	019	025	12.00	150
TM-69MXL	012	019	025	6.96	87	TM-122MXL	012	019	025	12.24	153

Cream Colored Engineered Polymer with Fiberglass Cord (RoHS compliant)

If you don't see the belt you need – call York!

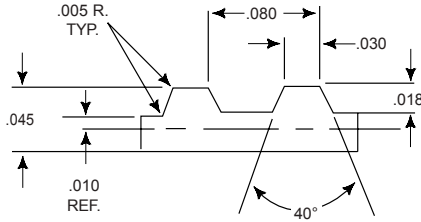

BELT NUMBER	1/8"	WIDTHS 3/16"	1/4"	PITCH LENGTH	NO. OF TEETH	BELT NUMBER	1/8"	WIDTHS 3/16"	1/4"	PITCH LENGTH	NO. OF TEETH
TM-124MXL	:012	:019	:025	12.40	155	TM-240MXL	:012	:019	:025	24.00	300
TM-126MXL	:012	:019	:025	12.64	158	TM-252MXL	:012	:019	:025	25.20	315
TM-128MXL	:012	:019	:025	12.80	160	TM-254MXL	:012	:019	:025	25.44	318
TM-132MXL	:012	:019	:025	13.20	165	TM-274MXL	:012	:019	:025	27.44	343
TM-133MXL	:012	:019	:025	13.28	166	TM-277MXL	:012	:019	:025	27.76	347
TM-136MXL	:012	:019	:025	13.60	170	TM-286MXL	:012	:019	:025	28.64	358
TM-140MXL	:012	:019	:025	14.00	175	TM-288MXL	:012	:019	:025	28.80	360
TM-144MXL	:012	:019	:025	14.40	180	TM-297MXL	:012	:019	:025	29.68	371
TM-147MXL	:012	:019	:025	14.72	184	TM-298MXL	:012	:019	:025	29.76	372
TM-152MXL	:012	:019	:025	15.20	190	TM-312MXL	:012	:019	:025	31.20	390
TM-156MXL	:012	:019	:025	15.60	195	TM-320MXL	:012	:019	:025	32.00	400
TM-160MXL	:012	:019	:025	16.00	200	TM-326MXL	:012	:019	:025	32.64	408
TM-166MXL	:012	:019	:025	16.64	208	TM-330MXL	:012	:019	:025	32.96	412
TM-168MXL	:012	:019	:025	16.80	210	TM-336MXL	:012	:019	:025	33.60	420
TM-170MXL	:012	:019	:025	16.96	212	TM-339MXL	:012	:019	:025	33.92	424
TM-177MXL	:012	:019	:025	17.68	221	TM-340MXL	:012	:019	:025	34.00	425
TM-178MXL	:012	:019	:025	17.76	222	TM-345MXL	:012	:019	:025	34.48	431
TM-180MXL	:012	:019	:025	18.00	225	TM-347MXL	:012	:019	:025	34.72	434
TM-183MXL	:012	:019	:025	18.32	229	TM-348MXL	:012	:019	:025	34.80	435
TM-184MXL	:012	:019	:025	18.40	230	TM-352MXL	:012	:019	:025	35.20	440
TM-186MXL	:012	:019	:025	18.56	232	TM-362MXL	:012	:019	:025	36.24	453
TM-188MXL	:012	:019	:025	18.80	235	TM-370MXL	:012	:019	:025	37.04	463
TM-196MXL	:012	:019	:025	19.60	245	TM-380MXL	:012	:019	:025	38.00	475
TM-198MXL	:012	:019	:025	19.84	248	TM-389MXL	:012	:019	:025	38.96	487
TM-199MXL	:012	:019	:025	19.92	249	TM-390MXL	:012	:019	:025	39.04	488
TM-200MXL	:012	:019	:025	20.00	250	TM-398MXL	:012	:019	:025	39.84	498
TM-201MXL	:012	:019	:025	20.08	251	TM-400MXL	:012	:019	:025	40.00	500
TM-205MXL	:012	:019	:025	20.48	256	TM-404MXL	:012	:019	:025	40.40	505
TM-208MXL	:012	:019	:025	20.80	260	TM-426MXL	:012	:019	:025	42.56	532
TM-212MXL	:012	:019	:025	21.20	265	TM-437MXL	:012	:019	:025	43.68	546
TM-214MXL	:012	:019	:025	21.36	267	TM-474MXL	:012	:019	:025	47.36	592
TM-224MXL	:012	:019	:025	22.40	280	TM-480MXL	:012	:019	:025	48.00	600
TM-236MXL	:012	:019	:025	23.60	295	TM-490MXL	:012	:019	:025	48.96	612
TM-238MXL	:012	:019	:025	23.84	298	TM-518MXL	:012	:019	:025	51.84	648

York also manufactures custom pulleys and complete assemblies
 email: support@york-ind.com web: www.york-ind.com





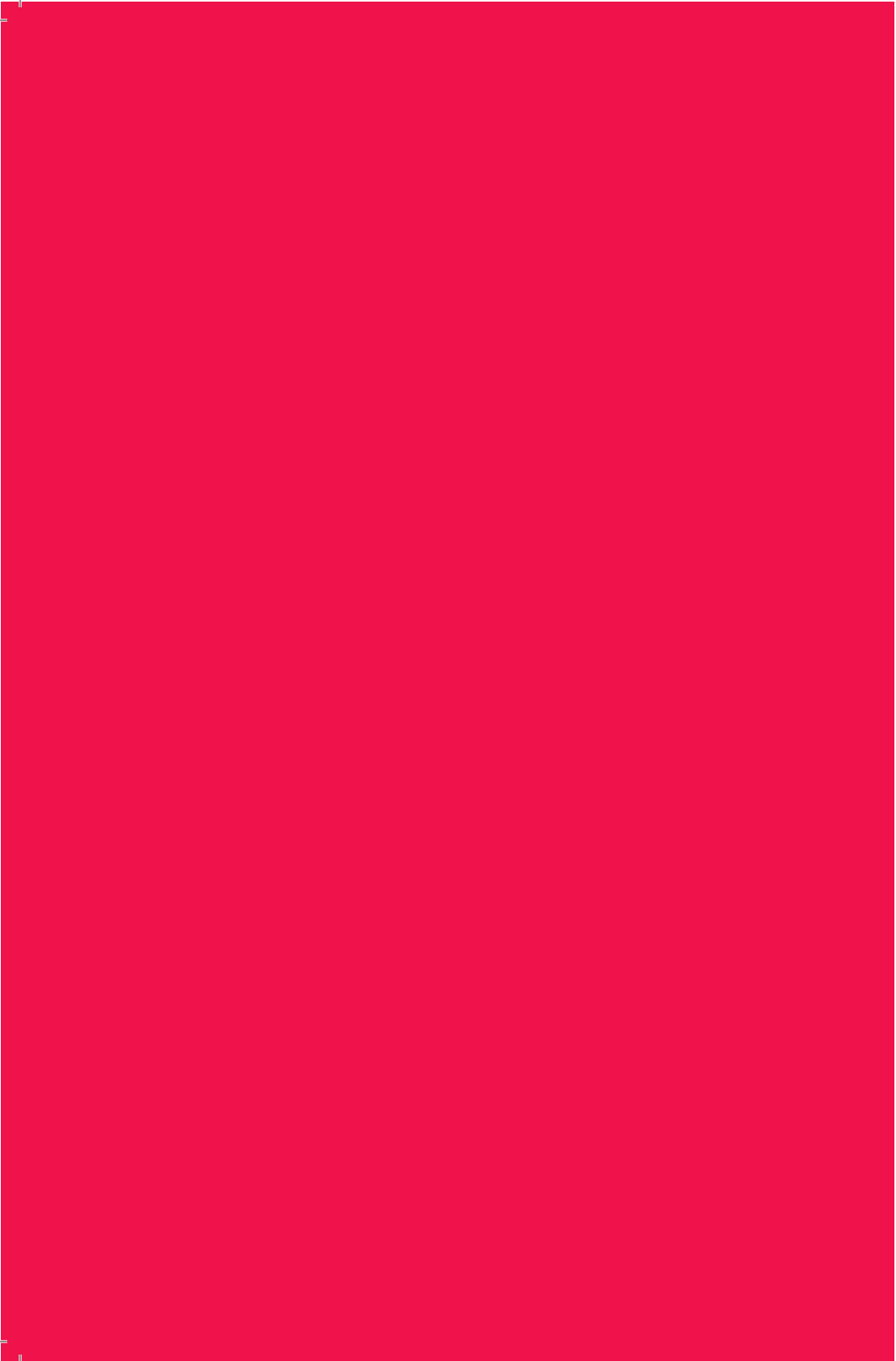

.0816 (40DP)

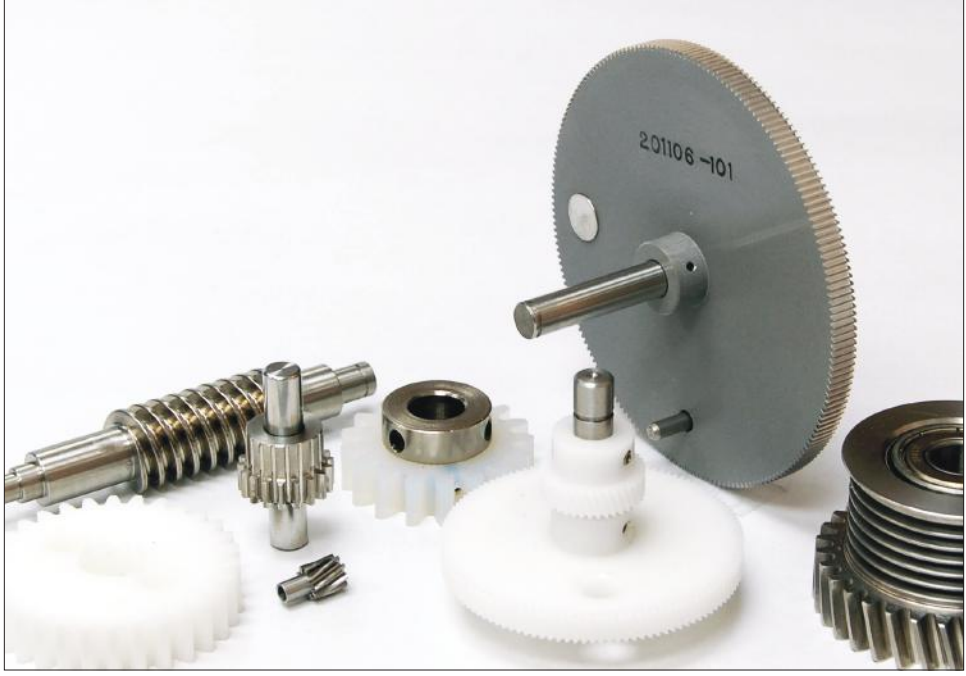

ALUMINUM WITH CLEAR ANODIZE (RoHS compliant)

FOR BELTS UP TO 3/16" WIDE

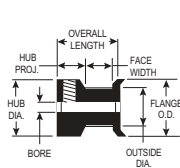

TYPE 6FC

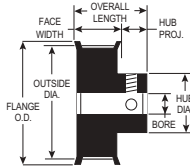

TYPE 6F



PART NUMBER	NO. OF GROOVES	PITCH DIA.	OUTSIDE DIA.	FLANGE O.D.	BORE (+.001 / -.000)	FACE WIDTH	OVERALL LENGTH	HUB PROJ.	HUB DIA.	SET SCREWS
10M187-6A X 3/32	10	.260	.246	.425	6FC .0938	.220	1/2	15/64	.425	2-64(1)
SAV-10M187-6A X 3/32	10	.260	.246	.425	6FC .0938	.220	1/2	15/64	.425	2-64(1)
10M187-6A X 1/8	10	.260	.246	.425	6FC .1250	.220	1/2	15/64	.425	4-40(1)
SAV-10M187-6A X 1/8	10	.260	.246	.425	6FC .1250	.220	1/2	15/64	.425	4-40(1)
11M187-6A X 3/32	11	.286	.272	.450	6FC .0938	.220	1/2	15/64	.450	2-64(1)
SAV-11M187-6A X 3/32	11	.286	.272	.450	6FC .0938	.220	1/2	15/64	.450	2-64(1)
11M187-6A X 1/8	11	.286	.272	.450	6FC .1250	.220	1/2	15/64	.450	4-40(1)
SAV-11M187-6A X 1/8	11	.286	.272	.450	6FC .1250	.220	1/2	15/64	.450	4-40(1)
12M187-6A X 3/32	12	.312	.298	.480	6FC .0938	.220	1/2	15/64	.480	2-64(1)
SAV-12M187-6A X 3/32	12	.312	.298	.480	6FC .0938	.220	1/2	15/64	.480	2-64(1)
12M187-6A X 1/8	12	.312	.298	.480	6FC .1250	.220	1/2	15/64	.480	4-40(1)
SAV-12M187-6A X 1/8	12	.312	.298	.480	6FC .1250	.220	1/2	15/64	.480	4-40(1)
13M187-6A X 1/8	13	.338	.324	.505	6FC .1250	.220	1/2	15/64	.505	4-40(1)
SAV-13M187-6A X 1/8	13	.338	.324	.505	6FC .1250	.220	1/2	15/64	.505	4-40(1)
14M187-6A X 1/8	14	.364	.350	.530	6FC .1250	.220	1/2	15/64	.530	4-40(1)
SAV-14M187-6A X 1/8	14	.364	.350	.530	6FC .1250	.220	1/2	15/64	.530	4-40(1)
15M187-6A X 1/8	15	.390	.376	.555	6FC .1250	.220	1/2	15/64	.555	4-40(1)
SAV-15M187-6A X 1/8	15	.390	.376	.555	6FC .1250	.220	1/2	15/64	.555	4-40(1)
15M187-6A X 3/16	15	.390	.376	.555	6FC .1875	.220	1/2	15/64	.555	4-40(1)
SAV-15M187-6A X 3/16	15	.390	.376	.555	6FC .1875	.220	1/2	15/64	.555	4-40(1)
16M187-6A X 1/8	16	.416	.402	.580	6FC .1250	.220	1/2	15/64	.580	4-40(1)
SAV-16M187-6A X 1/8	16	.416	.402	.580	6FC .1250	.220	1/2	15/64	.580	4-40(1)
16M187-6A X 3/16	16	.416	.402	.580	6FC .1875	.220	1/2	15/64	.580	4-40(1)
SAV-16M187-6A X 3/16	16	.416	.402	.580	6FC .1875	.220	1/2	15/64	.580	4-40(1)
18M187-6A X 1/4	18	.468	.454	.635	6FC .2500	.220	1/2	15/64	.635	8-32(2)
SAV-18M187-6A X 1/4	18	.468	.454	.635	6FC .2500	.220	1/2	15/64	.635	8-32(2)
20M187-6A X 1/4	20	.520	.506	.685	6FC .2500	.220	1/2	15/64	.685	8-32(2)
SAV-20M187-6A X 1/4	20	.520	.506	.685	6FC .2500	.220	1/2	15/64	.685	8-32(2)
21M187-6A X 1/4	21	.546	.532	.710	6FC .2500	.220	1/2	15/64	.710	8-32(2)
SAV-21M187-6A X 1/4	21	.546	.532	.710	6FC .2500	.220	1/2	15/64	.710	8-32(2)
22M187-6A X 1/4	22	.572	.558	.740	6FC .2500	.220	1/2	15/64	.740	8-32(2)
SAV-22M187-6A X 1/4	22	.572	.558	.740	6FC .2500	.220	1/2	15/64	.740	8-32(2)
18M187-1A X 1/8	18	.468	.454	.635	6F .1250	.324	9/16	15/64	.312	4-40(2)
SAV-18M187-1A X 1/8	18	.468	.454	.635	6F .1250	.324	9/16	15/64	.312	4-40(2)
18M187-1A X 3/16	18	.468	.454	.635	6F .1875	.324	9/16	15/64	.312	6-40(2)
SAV-18M187-1A X 3/16	18	.468	.454	.635	6F .1875	.324	9/16	15/64	.312	6-40(2)

"SAV-" in front of any standard timing pulley part # represents the Shaft-Saver version. Shaft-Saver pulleys have special setscrews that grip without damage to the shaft and allow easy pulley removal and realignment. For additional information, see our Shaft-Saver Engineering Section.

ALUMINUM WITH CLEAR ANODIZE (RoHS compliant)

FOR BELTS UP TO 3/16" WIDE

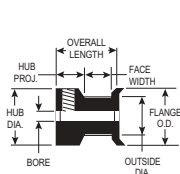

TYPE 6FC

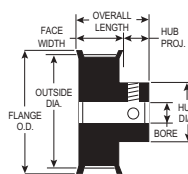

TYPE 6F

PART NUMBER	NO. OF GROOVES	PITCH DIA.	OUTSIDE DIA.	FLANGE O.D.	BORE (+.001) (-.000)	FACE WIDTH	OVERALL LENGTH	HUB PROJ.	HUB DIA.	SET SCREWS
20M187-1A X 1/8	20	.520	.506	.685	6F .1250	.324	9/16	15/64	.364	4-40(2)
SAV-20M187-1A X 1/8	20	.520	.506	.685	6F .1250	.324	9/16	15/64	.364	4-40(2)
20M187-1A X 3/16	20	.520	.506	.685	6F .1875	.324	9/16	15/64	.364	6-40(2)
SAV-20M187-1A X 3/16	20	.520	.506	.685	6F .1875	.324	9/16	15/64	.364	6-40(2)
21M187-1A X 1/8	21	.546	.532	.710	6F .1250	.324	9/16	15/64	.390	4-40(2)
SAV-21M187-1A X 1/8	21	.546	.532	.710	6F .1250	.324	9/16	15/64	.390	4-40(2)
21M187-1A X 3/16	21	.546	.532	.710	6F .1875	.324	9/16	15/64	.390	6-40(2)
SAV-21M187-1A X 3/16	21	.546	.532	.710	6F .1875	.324	9/16	15/64	.390	6-40(2)
22M187-1A X 1/8	22	.572	.558	.740	6F .1250	.324	9/16	15/64	.390	4-40(2)
SAV-22M187-1A X 1/8	22	.572	.558	.740	6F .1250	.324	9/16	15/64	.390	4-40(2)
22M187-1A X 3/16	22	.572	.558	.740	6F .1875	.324	9/16	15/64	.390	6-40(2)
SAV-22M187-1A X 3/16	22	.572	.558	.740	6F .1875	.324	9/16	15/64	.390	6-40(2)
24M187-1A X 3/16	24	.624	.610	.790	6F .1875	.324	5/8	19/64	.442	6-40(2)
SAV-24M187-1A X 3/16	24	.624	.610	.790	6F .1875	.324	5/8	19/64	.442	6-40(2)
24M187-1A X 1/4	24	.624	.610	.790	6F .2500	.324	5/8	19/64	.442	6-40(2)
SAV-24M187-1A X 1/4	24	.624	.610	.790	6F .2500	.324	5/8	19/64	.442	6-40(2)
25M187-1A X 3/16	25	.650	.636	.815	6F .1875	.324	5/8	19/64	.468	6-40(2)
SAV-25M187-1A X 3/16	25	.650	.636	.815	6F .1875	.324	5/8	19/64	.468	6-40(2)
25M187-1A X 1/4	25	.650	.636	.815	6F .2500	.324	5/8	19/64	.468	6-40(2)
SAV-25M187-1A X 1/4	25	.650	.636	.815	6F .2500	.324	5/8	19/64	.468	6-40(2)
26M187-1A X 3/16	26	.676	.662	.840	6F .1875	.324	5/8	19/64	.494	6-40(2)
SAV-26M187-1A X 3/16	26	.676	.662	.840	6F .1875	.324	5/8	19/64	.494	6-40(2)
26M187-1A X 1/4	26	.676	.662	.840	6F .2500	.324	5/8	19/64	.494	6-40(2)
SAV-26M187-1A X 1/4	26	.676	.662	.840	6F .2500	.324	5/8	19/64	.494	6-40(2)
28M187-1A X 3/16	28	.728	.714	.895	6F .1875	.324	5/8	19/64	.494	6-40(2)
SAV-28M187-1A X 3/16	28	.728	.714	.895	6F .1875	.324	5/8	19/64	.494	6-40(2)
28M187-1A X 1/4	28	.728	.714	.895	6F .2500	.324	5/8	19/64	.494	6-40(2)
SAV-28M187-1A X 1/4	28	.728	.714	.895	6F .2500	.324	5/8	19/64	.494	6-40(2)

"SAV-" in front of any standard timing pulley part # represents the Shaft-Saver version. Shaft-Saver pulleys have special setscrews that grip without damage to the shaft and allow easy pulley removal and realignment. For additional information, see our Shaft-Saver Engineering Section.

ALUMINUM WITH CLEAR ANODIZE (RoHS compliant)

FOR BELTS UP TO 3/16" WIDE

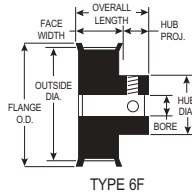

PART NUMBER	NO. OF GROOVES	PITCH DIA.	OUTSIDE DIA.	FLANGE O.D.	TYPE	BORE (+.001 / -.000)	FACE WIDTH	OVERALL LENGTH	HUB PROJ.	HUB DIA.	SET SCREWS
30M187-1A X 3/16	30	.780	.766	.945	6F	.1875	.324	5/8	19/64	.546	6-40(2)
SAV-30M187-1A X 3/16	30	.780	.766	.945	6F	.1875	.324	5/8	19/64	.546	6-40(2)
30M187-1A X 1/4	30	.780	.766	.945	6F	.2500	.324	5/8	19/64	.546	8-32(2)
SAV-30M187-1A X 1/4	30	.780	.766	.945	6F	.2500	.324	5/8	19/64	.546	8-32(2)
32M187-1A X 3/16	32	.832	.818	1.000	6F	.1875	.324	5/8	19/64	.598	6-40(2)
SAV-32M187-1A X 3/16	32	.832	.818	1.000	6F	.1875	.324	5/8	19/64	.598	6-40(2)
32M187-1A X 1/4	32	.832	.818	1.000	6F	.2500	.324	5/8	19/64	.598	8-32(2)
SAV-32M187-1A X 1/4	32	.832	.818	1.000	6F	.2500	.324	5/8	19/64	.598	8-32(2)
33M187-1A X 3/16	33	.858	.844	1.025	6F	.1875	.324	5/8	19/64	.624	6-40(2)
SAV-33M187-1A X 3/16	33	.858	.844	1.025	6F	.1875	.324	5/8	19/64	.624	6-40(2)
33M187-1A X 1/4	33	.858	.844	1.025	6F	.2500	.324	5/8	19/64	.624	8-32(2)
SAV-33M187-1A X 1/4	33	.858	.844	1.025	6F	.2500	.324	5/8	19/64	.624	8-32(2)
34M187-1A X 3/16	34	.884	.870	1.050	6F	.1875	.324	5/8	19/64	.624	6-40(2)
SAV-34M187-1A X 3/16	34	.884	.870	1.050	6F	.1875	.324	5/8	19/64	.624	6-40(2)
34M187-1A X 1/4	34	.884	.870	1.050	6F	.2500	.324	5/8	19/64	.624	8-32(2)
SAV-34M187-1A X 1/4	34	.884	.870	1.050	6F	.2500	.324	5/8	19/64	.624	8-32(2)
35M187-1A X 3/16	35	.910	.896	1.080	6F	.1875	.324	5/8	19/64	.650	6-40(2)
SAV-35M187-1A X 3/16	35	.910	.896	1.080	6F	.1875	.324	5/8	19/64	.650	6-40(2)
35M187-1A X 1/4	35	.910	.896	1.080	6F	.2500	.324	5/8	19/64	.650	8-32(2)
SAV-35M187-1A X 1/4	35	.910	.896	1.080	6F	.2500	.324	5/8	19/64	.650	8-32(2)
36M187-1A X 3/16	36	.936	.922	1.105	6F	.1875	.324	5/8	19/64	.676	6-40(2)
SAV-36M187-1A X 3/16	36	.936	.922	1.105	6F	.1875	.324	5/8	19/64	.676	6-40(2)
36M187-1A X 1/4	36	.936	.922	1.105	6F	.2500	.324	5/8	19/64	.676	8-32(2)
SAV-36M187-1A X 1/4	36	.936	.922	1.105	6F	.2500	.324	5/8	19/64	.676	8-32(2)
38M187-1A X 1/4	38	.988	.974	1.155	6F	.2500	.324	5/8	19/64	.728	8-32(2)
SAV-38M187-1A X 1/4	38	.988	.974	1.155	6F	.2500	.324	5/8	19/64	.728	8-32(2)
38M187-1A X 5/16	38	.988	.974	1.155	6F	.3125	.324	5/8	19/64	.728	8-32(2)
SAV-38M187-1A X 5/16	38	.988	.974	1.155	6F	.3125	.324	5/8	19/64	.728	8-32(2)
40M187-1A X 1/4	40	1.040	1.026	1.210	6F	.2500	.340	21/32	21/64	.754	8-32(2)
SAV-40M187-1A X 1/4	40	1.040	1.026	1.210	6F	.2500	.340	21/32	21/64	.754	8-32(2)
40M187-1A X 5/16	40	1.040	1.026	1.210	6F	.3125	.340	21/32	21/64	.754	8-32(2)
SAV-40M187-1A X 5/16	40	1.040	1.026	1.210	6F	.3125	.340	21/32	21/64	.754	8-32(2)
42M187-1A X 1/4	42	1.092	1.078	1.260	6F	.2500	.340	21/32	21/64	.806	8-32(2)
SAV-42M187-1A X 1/4	42	1.092	1.078	1.260	6F	.2500	.340	21/32	21/64	.806	8-32(2)
42M187-1A X 5/16	42	1.092	1.078	1.260	6F	.3125	.340	21/32	21/64	.806	8-32(2)
SAV-42M187-1A X 5/16	42	1.092	1.078	1.260	6F	.3125	.340	21/32	21/64	.806	8-32(2)
44M187-1A X 1/4	44	1.144	1.130	1.315	6F	.2500	.340	21/32	21/64	.858	8-32(2)
SAV-44M187-1A X 1/4	44	1.144	1.130	1.315	6F	.2500	.340	21/32	21/64	.858	8-32(2)

"SAV." in front of any standard timing pulley part # represents the Shaft-Saver version. Shaft-Saver pulleys have special setscrews that grip without damage to the shaft and allow easy pulley removal and realignment. For additional information, see our Shaft-Saver Engineering Section.

York also manufactures custom pulleys and complete assemblies
 email:support@york-ind.com web: www.york-ind.com



ALUMINUM WITH CLEAR ANODIZE (RoHS compliant)

FOR BELTS UP TO 3/16" WIDE

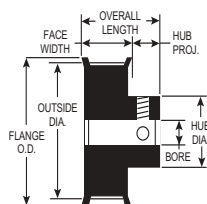

TYPE 6F

PART NUMBER	NO. OF GROOVES	PITCH DIA.	OUTSIDE DIA.	FLANGE O.D.	BORE (+.001) (-.000)	FACE WIDTH	OVERALL LENGTH	HUB PROJ.	HUB DIA.	SET SCREWS
44M187-1A X 5/16	44	1.144	1.130	1.315	6F .3125	.340	21/32	21/64	.858	8-32(2)
SAV-44M187-1A X 5/16	44	1.144	1.130	1.315	6F .3125	.340	21/32	21/64	.858	8-32(2)
45M187-1A X 1/4	45	1.170	1.156	1.340	6F .2500	.340	21/32	21/64	.884	8-32(2)
SAV-45M187-1A X 1/4	45	1.170	1.156	1.340	6F .2500	.340	21/32	21/64	.884	8-32(2)
45M187-1A X 5/16	45	1.170	1.156	1.340	6F .3125	.340	21/32	21/64	.884	8-32(2)
SAV-45M187-1A X 5/16	45	1.170	1.156	1.340	6F .3125	.340	21/32	21/64	.884	8-32(2)
48M187-1A X 1/4	48	1.248	1.234	1.420	6F .2500	.340	21/32	21/64	.936	8-32(2)
SAV-48M187-1A X 1/4	48	1.248	1.234	1.420	6F .2500	.340	21/32	21/64	.936	8-32(2)
48M187-1A X 5/16	48	1.248	1.234	1.420	6F .3125	.340	21/32	21/64	.936	8-32(2)
SAV-48M187-1A X 5/16	48	1.248	1.234	1.420	6F .3125	.340	21/32	21/64	.936	8-32(2)
50M187-1A X 1/4	50	1.300	1.286	1.470	6F .2500	.340	21/32	21/64	.988	8-32(2)
SAV-50M187-1A X 1/4	50	1.300	1.286	1.470	6F .2500	.340	21/32	21/64	.988	8-32(2)
50M187-1A X 5/16	50	1.300	1.286	1.470	6F .3125	.340	21/32	21/64	.988	8-32(2)
SAV-50M187-1A X 5/16	50	1.300	1.286	1.470	6F .3125	.340	21/32	21/64	.988	8-32(2)
54M187-1A X 1/4	54	1.404	1.390	1.575	6F .2500	.340	21/32	21/64	1.066	8-32(2)
SAV-54M187-1A X 1/4	54	1.404	1.390	1.575	6F .2500	.340	21/32	21/64	1.066	8-32(2)
54M187-1A X 5/16	54	1.404	1.390	1.575	6F .3125	.340	21/32	21/64	1.066	8-32(2)
SAV-54M187-1A X 5/16	54	1.404	1.390	1.575	6F .3125	.340	21/32	21/64	1.066	8-32(2)
60M187-1A X 1/4	60	1.560	1.546	1.730	6F .2500	.340	21/32	21/64	1.222	8-32(2)
SAV-60M187-1A X 1/4	60	1.560	1.546	1.730	6F .2500	.340	21/32	21/64	1.222	8-32(2)
60M187-1A X 5/16	60	1.560	1.546	1.730	6F .3125	.340	21/32	21/64	1.222	8-32(2)
SAV-60M187-1A X 5/16	60	1.560	1.546	1.730	6F .3125	.340	21/32	21/64	1.222	8-32(2)

“SAV-” in front of any standard timing pulley part # represents the Shaft-Saver version. Shaft-Saver pulleys have special setscrews that grip without damage to the shaft and allow easy pulley removal and realignment. For additional information, see our Shaft-Saver Engineering Section.

TIMING BELT PULLEYS

.0816" (40 D.P.) PITCH

ALUMINUM WITH CLEAR ANODIZE (RoHS compliant)

FOR BELTS UP TO 3/16" WIDE

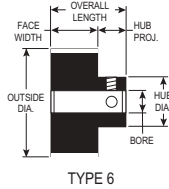

PART NUMBER	NO. OF GROOVES	PITCH DIA.	OUTSIDE DIA.	TYPE	BORE (+.001 / -.000)	FACE WIDTH	OVERALL LENGTH	HUB PROJ.	HUB DIA.	SET SCREWS (2@90°)
20M187-2A X 3/16	20	.520	.506	6	.1875	3/8	3/4	3/8	.436	6-40
SAV-20M187-2A X 3/16	20	.520	.506	6	.1875	3/8	3/4	3/8	.436	6-40
20M187-2A X 1/4	20	.520	.506	6	.2500	3/8	3/4	3/8	.436	6-40
SAV-20M187-2A X 1/4	20	.520	.506	6	.2500	3/8	3/4	3/8	.436	6-40
24M187-2A X 3/16	24	.624	.610	6	.1875	3/8	3/4	3/8	.500	6-40
SAV-24M187-2A X 3/16	24	.624	.610	6	.1875	3/8	3/4	3/8	.500	6-40
24M187-2A X 1/4	24	.624	.610	6	.2500	3/8	3/4	3/8	.500	8-32
SAV-24M187-2A X 1/4	24	.624	.610	6	.2500	3/8	3/4	3/8	.500	8-32
30M187-2A X 1/4	30	.780	.766	6	.2500	3/8	3/4	3/8	.656	8-32
SAV-30M187-2A X 1/4	30	.780	.766	6	.2500	3/8	3/4	3/8	.656	8-32
40M187-2A X 1/4	40	1.040	1.026	6	.2500	3/8	3/4	3/8	.666	8-32
SAV-40M187-2A X 1/4	40	1.040	1.026	6	.2500	3/8	3/4	3/8	.666	8-32
45M187-2A X 1/4	45	1.170	1.156	6	.2500	3/8	3/4	3/8	.796	8-32
SAV-45M187-2A X 1/4	45	1.170	1.156	6	.2500	3/8	3/4	3/8	.796	8-32
50M187-2A X 1/4	50	1.300	1.286	6	.2500	3/8	3/4	3/8	.926	8-32
SAV-50M187-2A X 1/4	50	1.300	1.286	6	.2500	3/8	3/4	3/8	.926	8-32
50M187-2A X 5/16	50	1.300	1.286	6	.3125	3/8	3/4	3/8	.926	8-32
SAV-50M187-2A X 5/16	50	1.300	1.286	6	.3125	3/8	3/4	3/8	.926	8-32
60M187-2A X 1/4	60	1.560	1.546	6	.2500	3/8	3/4	3/8	1.187	8-32
SAV-60M187-2A X 1/4	60	1.560	1.546	6	.2500	3/8	3/4	3/8	1.187	8-32
60M187-2A X 5/16	60	1.560	1.546	6	.3125	3/8	3/4	3/8	1.187	8-32
SAV-60M187-2A X 5/16	60	1.560	1.546	6	.3125	3/8	3/4	3/8	1.187	8-32
70M187-2A X 1/4	70	1.820	1.806	6	.2500	3/8	3/4	3/8	1.150	8-32
SAV-70M187-2A X 1/4	70	1.820	1.806	6	.2500	3/8	3/4	3/8	1.150	8-32
70M187-2A X 3/8	70	1.820	1.806	6	.3750	3/8	3/4	3/8	1.150	10-32
SAV-70M187-2A X 3/8	70	1.820	1.806	6	.3750	3/8	3/4	3/8	1.150	10-32
72M187-2A X 1/4	72	1.872	1.858	6	.2500	3/8	3/4	3/8	1.202	8-32
SAV-72M187-2A X 1/4	72	1.872	1.858	6	.2500	3/8	3/4	3/8	1.202	8-32
72M187-2A X 3/8	72	1.872	1.858	6	.3750	3/8	3/4	3/8	1.202	10-32
SAV-72M187-2A X 3/8	72	1.872	1.858	6	.3750	3/8	3/4	3/8	1.202	10-32
75M187-2A X 1/4	75	1.950	1.936	6	.2500	3/8	3/4	3/8	1.266	8-32
SAV-75M187-2A X 1/4	75	1.950	1.936	6	.2500	3/8	3/4	3/8	1.266	8-32
75M187-2A X 3/8	75	1.950	1.936	6	.3750	3/8	3/4	3/8	1.266	10-32
SAV-75M187-2A X 3/8	75	1.950	1.936	6	.3750	3/8	3/4	3/8	1.266	10-32
80M187-2A X 1/4	80	2.080	2.066	6	.2500	3/8	3/4	3/8	1.396	8-32
SAV-80M187-2A X 1/4	80	2.080	2.066	6	.2500	3/8	3/4	3/8	1.396	8-32
80M187-2A X 3/8	80	2.080	2.066	6	.3750	3/8	3/4	3/8	1.396	10-32
SAV-80M187-2A X 3/8	80	2.080	2.066	6	.3750	3/8	3/4	3/8	1.396	10-32

“SAV-” in front of any standard timing pulley part # represents the Shaft-Saver version. Shaft-Saver pulleys have special setscrews that grip without damage to the shaft and allow easy pulley removal and realignment. For additional information, see our Shaft-Saver Engineering Section.

York also manufactures custom pulleys and complete assemblies
 email:support@york-ind.com web: www.york-ind.com



ALUMINUM WITH CLEAR ANODIZE (RoHS compliant)

FOR BELTS UP TO 3/16" WIDE

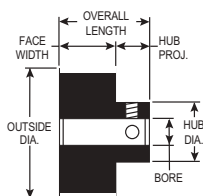

TYPE 6

PART NUMBER	NO. OF GROOVES	PITCH DIA	OUTSIDE DIA	TYPE	BORE (+.001) (-.000)	FACE WIDTH	OVERALL LENGTH	HUB PROJ.	HUB DIA	SET SCREWS (2@90°)
84M187-2A X 1/4	84	2.184	2.170	6	.2500	3/8	3/4	3/8	1.500	8-32
SAV-84M187-2A X 1/4	84	2.184	2.170	6	.2500	3/8	3/4	3/8	1.500	8-32
84M187-2A X 3/8	84	2.184	2.170	6	.3750	3/8	3/4	3/8	1.500	10-32
SAV-84M187-2A X 3/8	84	2.184	2.170	6	.3750	3/8	3/4	3/8	1.500	10-32
88M187-2A X 1/4	88	2.288	2.274	6	.2500	3/8	3/4	3/8	1.500	8-32
SAV-88M187-2A X 1/4	88	2.288	2.274	6	.2500	3/8	3/4	3/8	1.500	8-32
88M187-2A X 3/8	88	2.288	2.274	6	.3750	3/8	3/4	3/8	1.500	10-32
SAV-88M187-2A X 3/8	88	2.288	2.274	6	.3750	3/8	3/4	3/8	1.500	10-32
90M187-2A X 1/4	90	2.340	2.326	6	.2500	3/8	3/4	3/8	1.500	8-32
SAV-90M187-2A X 1/4	90	2.340	2.326	6	.2500	3/8	3/4	3/8	1.500	8-32
90M187-2A X 3/8	90	2.340	2.326	6	.3750	3/8	3/4	3/8	1.500	10-32
SAV-90M187-2A X 3/8	90	2.340	2.326	6	.3750	3/8	3/4	3/8	1.500	10-32
96M187-2A X 1/4	96	2.496	2.482	6	.2500	3/8	3/4	3/8	1.500	8-32
SAV-96M187-2A X 1/4	96	2.496	2.482	6	.2500	3/8	3/4	3/8	1.500	8-32
96M187-2A X 3/8	96	2.496	2.482	6	.3750	3/8	3/4	3/8	1.500	10-32
SAV-96M187-2A X 3/8	96	2.496	2.482	6	.3750	3/8	3/4	3/8	1.500	10-32
98M187-2A X 1/4	98	2.548	2.534	6	.2500	3/8	3/4	3/8	1.500	8-32
SAV-98M187-2A X 1/4	98	2.548	2.534	6	.2500	3/8	3/4	3/8	1.500	8-32
98M187-2A X 3/8	98	2.548	2.534	6	.3750	3/8	3/4	3/8	1.500	10-32
SAV-98M187-2A X 3/8	98	2.548	2.534	6	.3750	3/8	3/4	3/8	1.500	10-32
100M187-2A X 1/4	100	2.600	2.586	6	.2500	3/8	3/4	3/8	1.500	8-32
SAV-100M187-2A X 1/4	100	2.600	2.586	6	.2500	3/8	3/4	3/8	1.500	8-32
100M187-2A X 3/8	100	2.600	2.586	6	.3750	3/8	3/4	3/8	1.500	10-32
SAV-100M187-2A X 3/8	100	2.600	2.586	6	.3750	3/8	3/4	3/8	1.500	10-32
108M187-2A X 1/4	108	2.808	2.794	6	.2500	3/8	3/4	3/8	1.500	8-32
SAV-108M187-2A X 1/4	108	2.808	2.794	6	.2500	3/8	3/4	3/8	1.500	8-32
108M187-2A X 3/8	108	2.808	2.794	6	.3750	3/8	3/4	3/8	1.500	10-32
SAV-108M187-2A X 3/8	108	2.808	2.794	6	.3750	3/8	3/4	3/8	1.500	10-32
120M187-2A X 1/4	120	3.120	3.106	6	.2500	3/8	3/4	3/8	1.500	8-32
SAV-120M187-2A X 1/4	120	3.120	3.106	6	.2500	3/8	3/4	3/8	1.500	8-32
120M187-2A X 3/8	120	3.120	3.106	6	.3750	3/8	3/4	3/8	1.500	10-32
SAV-120M187-2A X 3/8	120	3.120	3.106	6	.3750	3/8	3/4	3/8	1.500	10-32

“SAV-” in front of any standard timing pulley part # represents the Shaft-Saver version. Shaft-Saver pulleys have special setscrews that grip without damage to the shaft and allow easy pulley removal and realignment. For additional information, see our Shaft-Saver Engineering Section.

ALUMINUM WITH CLEAR ANODIZE (RoHS compliant)

FOR BELTS UP TO 5/16" WIDE

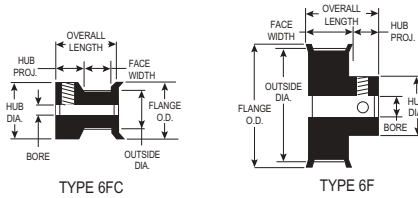

PART NUMBER	NO. OF GROOVES	PITCH DIA.	OUTSIDE DIA.	FLANGE O.D.	TYPE	BORE (+.001) (-.000)	FACE WIDTH	OVERALL LENGTH	HUB PROJ.	HUB DIA.	SET SCREWS
10M312-6A X 3/32	10	.260	.246	.425	6FC	.0938	.345	5/8	15/64	.425	2-64(1)
SAV-10M312-6A X 3/32	10	.260	.246	.425	6FC	.0938	.345	5/8	15/64	.425	2-64(1)
10M312-6A X 1/8	10	.260	.246	.425	6FC	.1250	.345	5/8	15/64	.425	4-40(1)
SAV-10M312-6A X 1/8	10	.260	.246	.425	6FC	.1250	.345	5/8	15/64	.425	4-40(1)
11M312-6A X 3/32	11	.286	.272	.450	6FC	.0938	.345	5/8	15/64	.450	2-64(1)
SAV-11M312-6A X 3/32	11	.286	.272	.450	6FC	.0938	.345	5/8	15/64	.450	2-64(1)
11M312-6A X 1/8	11	.286	.272	.450	6FC	.1250	.345	5/8	15/64	.450	4-40(1)
SAV-11M312-6A X 1/8	11	.286	.272	.450	6FC	.1250	.345	5/8	15/64	.450	4-40(1)
12M312-6A X 3/32	12	.312	.298	.480	6FC	.0938	.345	5/8	15/64	.480	2-64(1)
SAV-12M312-6A X 3/32	12	.312	.298	.480	6FC	.0938	.345	5/8	15/64	.480	2-64(1)
12M312-6A X 1/8	12	.312	.298	.480	6FC	.1250	.345	5/8	15/64	.480	4-40(1)
SAV-12M312-6A X 1/8	12	.312	.298	.480	6FC	.1250	.345	5/8	15/64	.480	4-40(1)
13M312-6A X 1/8	13	.338	.324	.505	6FC	.1250	.345	5/8	15/64	.505	4-40(1)
SAV-13M312-6A X 1/8	13	.338	.324	.505	6FC	.1250	.345	5/8	15/64	.505	4-40(1)
14M312-6A X 1/8	14	.364	.350	.530	6FC	.1250	.345	5/8	15/64	.530	4-40(1)
SAV-14M312-6A X 1/8	14	.364	.350	.530	6FC	.1250	.345	5/8	15/64	.530	4-40(1)
15M312-6A X 1/8	15	.390	.376	.555	6FC	.1250	.345	5/8	15/64	.555	4-40(1)
SAV-15M312-6A X 1/8	15	.390	.376	.555	6FC	.1250	.345	5/8	15/64	.555	4-40(1)
15M312-6A X 3/16	15	.390	.376	.555	6FC	.1875	.345	5/8	15/64	.555	4-40(1)
SAV-15M312-6A X 3/16	15	.390	.376	.555	6FC	.1875	.345	5/8	15/64	.555	4-40(1)
16M312-6A X 1/8	16	.416	.402	.580	6FC	.1250	.345	5/8	15/64	.580	4-40(1)
SAV-16M312-6A X 1/8	16	.416	.402	.580	6FC	.1250	.345	5/8	15/64	.580	4-40(1)
16M312-6A X 3/16	16	.416	.402	.580	6FC	.1875	.345	5/8	15/64	.580	4-40(1)
SAV-16M312-6A X 3/16	16	.416	.402	.580	6FC	.1875	.345	5/8	15/64	.580	4-40(1)
18M312-6A X 1/4	18	.468	.454	.635	6FC	.2500	.345	5/8	15/64	.635	8-32(2)
SAV-18M312-6A X 1/4	18	.468	.454	.635	6FC	.2500	.345	5/8	15/64	.635	8-32(2)
20M312-6A X 1/4	20	.520	.506	.685	6FC	.2500	.345	5/8	15/64	.685	8-32(2)
SAV-20M312-6A X 1/4	20	.520	.506	.685	6FC	.2500	.345	5/8	15/64	.685	8-32(2)
21M312-6A X 1/4	21	.546	.532	.710	6FC	.2500	.345	5/8	15/64	.710	8-32(2)
SAV-21M312-6A X 1/4	21	.546	.532	.710	6FC	.2500	.345	5/8	15/64	.710	8-32(2)
22M312-6A X 1/4	22	.572	.558	.740	6FC	.2500	.345	5/8	15/64	.740	8-32(2)
SAV-22M312-6A X 1/4	22	.572	.558	.740	6FC	.2500	.345	5/8	15/64	.740	8-32(2)
18M312-1A X 1/8	18	.468	.454	.635	6F	.1250	.449	11/16	15/64	.312	4-40(2)
SAV-18M312-1A X 1/8	18	.468	.454	.635	6F	.1250	.449	11/16	15/64	.312	4-40(2)
18M312-1A X 3/16	18	.468	.454	.635	6F	.1875	.449	11/16	15/64	.312	6-40(2)
SAV-18M312-1A X 3/16	18	.468	.454	.635	6F	.1875	.449	11/16	15/64	.312	6-40(2)

“SAV-” in front of any standard timing pulley part # represents the Shaft-Saver version. Shaft-Saver pulleys have special setscrews that grip without damage to the shaft and allow easy pulley removal and realignment. For additional information, see our Shaft-Saver Engineering Section.



ALUMINUM WITH CLEAR ANODIZE (RoHS compliant)

FOR BELTS UP TO 5/16" WIDE

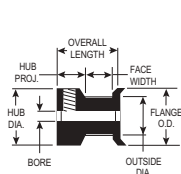

TYPE 6FC

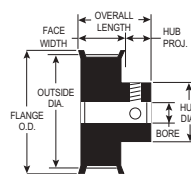

TYPE 6F

PART NUMBER	NO. OF GROOVES	PITCH DIA.	OUTSIDE DIA.	FLANGE O.D.	BORE (+.001) (-.000)	FACE WIDTH	OVERALL LENGTH	HUB PROJ.	HUB DIA.	SET SCREWS
20M312-1A X 1/8	20	.520	.506	.685	6F .1250	.449	11/16	15/64	.364	4-40(2)
SAV-20M312-1A X 1/8	20	.520	.506	.685	6F .1250	.449	11/16	15/64	.364	4-40(2)
20M312-1A X 3/16	20	.520	.506	.685	6F .1875	.449	11/16	15/64	.364	6-40(2)
SAV-20M312-1A X 3/16	20	.520	.506	.685	6F .1875	.449	11/16	15/64	.364	6-40(2)
21M312-1A X 1/8	21	.546	.532	.710	6F .1250	.449	11/16	15/64	.390	4-40(2)
SAV-21M312-1A X 1/8	21	.546	.532	.710	6F .1250	.449	11/16	15/64	.390	4-40(2)
21M312-1A X 3/16	21	.546	.532	.710	6F .1875	.449	11/16	15/64	.390	6-40(2)
SAV-21M312-1A X 3/16	21	.546	.532	.710	6F .1875	.449	11/16	15/64	.390	6-40(2)
22M312-1A X 1/8	22	.572	.558	.740	6F .1250	.449	11/16	15/64	.390	4-40(2)
SAV-22M312-1A X 1/8	22	.572	.558	.740	6F .1250	.449	11/16	15/64	.390	4-40(2)
22M312-1A X 3/16	22	.572	.558	.740	6F .1875	.449	11/16	15/64	.390	6-40(2)
SAV-22M312-1A X 3/16	22	.572	.558	.740	6F .1875	.449	11/16	15/64	.390	6-40(2)
24M312-1A X 3/16	24	.624	.610	.790	6F .1875	.449	3/4	19/64	.442	6-40(2)
SAV-24M312-1A X 3/16	24	.624	.610	.790	6F .1875	.449	3/4	19/64	.442	6-40(2)
24M312-1A X 1/4	24	.624	.610	.790	6F .2500	.449	3/4	19/64	.442	6-40(2)
SAV-24M312-1A X 1/4	24	.624	.610	.790	6F .2500	.449	3/4	19/64	.442	6-40(2)
25M312-1A X 3/16	25	.650	.636	.815	6F .1875	.449	3/4	19/64	.468	6-40(2)
SAV-25M312-1A X 3/16	25	.650	.636	.815	6F .1875	.449	3/4	19/64	.468	6-40(2)
25M312-1A X 1/4	25	.650	.636	.815	6F .2500	.449	3/4	19/64	.468	6-40(2)
SAV-25M312-1A X 1/4	25	.650	.636	.815	6F .2500	.449	3/4	19/64	.468	6-40(2)
26M312-1A X 3/16	26	.676	.662	.840	6F .1875	.449	3/4	19/64	.494	6-40(2)
SAV-26M312-1A X 3/16	26	.676	.662	.840	6F .1875	.449	3/4	19/64	.494	6-40(2)
26M312-1A X 1/4	26	.676	.662	.840	6F .2500	.449	3/4	19/64	.494	6-40(2)
SAV-26M312-1A X 1/4	26	.676	.662	.840	6F .2500	.449	3/4	19/64	.494	6-40(2)
28M312-1A X 3/16	28	.728	.714	.895	6F .1875	.449	3/4	19/64	.494	6-40(2)
SAV-28M312-1A X 3/16	28	.728	.714	.895	6F .1875	.449	3/4	19/64	.494	6-40(2)
28M312-1A X 1/4	28	.728	.714	.895	6F .2500	.449	3/4	19/64	.494	6-40(2)
SAV-28M312-1A X 1/4	28	.728	.714	.895	6F .2500	.449	3/4	19/64	.494	6-40(2)

"SAV-" in front of any standard timing pulley part # represents the Shaft-Saver version. Shaft-Saver pulleys have special setscrews that grip without damage to the shaft and allow easy pulley removal and realignment. For additional information, see our Shaft-Saver Engineering Section.

ALUMINUM WITH CLEAR ANODIZE (RoHS compliant)

FOR BELTS UP TO 5/16" WIDE

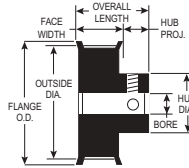

TYPE 6F



PART NUMBER	NO. OF GROOVES	PITCH DIA.	OUTSIDE DIA.	FLANGE O.D.	TYPE	BORE (+.001 / -.000)	FACE WIDTH	OVERALL LENGTH	HUB PROJ.	HUB DIA.	SET SCREWS
30M312-1A X 3/16	30	.780	.766	.945	6F	.1875	.449	3/4	19/64	.546	6-40(2)
SAV-30M312-1A X 3/16	30	.780	.766	.945	6F	.1875	.449	3/4	19/64	.546	6-40(2)
30M312-1A X 1/4	30	.780	.766	.945	6F	.2500	.449	3/4	19/64	.546	8-32(2)
SAV-30M312-1A X 1/4	30	.780	.766	.945	6F	.2500	.449	3/4	19/64	.546	8-32(2)
32M312-1A X 3/16	32	.832	.818	1.000	6F	.1875	.449	3/4	19/64	.598	6-40(2)
SAV-32M312-1A X 3/16	32	.832	.818	1.000	6F	.1875	.449	3/4	19/64	.598	6-40(2)
32M312-1A X 1/4	32	.832	.818	1.000	6F	.2500	.449	3/4	19/64	.598	8-32(2)
SAV-32M312-1A X 1/4	32	.832	.818	1.000	6F	.2500	.449	3/4	19/64	.598	8-32(2)
33M312-1A X 3/16	33	.858	.844	1.025	6F	.1875	.449	3/4	19/64	.624	6-40(2)
SAV-33M312-1A X 3/16	33	.858	.844	1.025	6F	.1875	.449	3/4	19/64	.624	6-40(2)
33M312-1A X 1/4	33	.858	.844	1.025	6F	.2500	.449	3/4	19/64	.624	8-32(2)
SAV-33M312-1A X 1/4	33	.858	.844	1.025	6F	.2500	.449	3/4	19/64	.624	8-32(2)
34M312-1A X 3/16	34	.884	.870	1.050	6F	.1875	.449	3/4	19/64	.624	6-40(2)
SAV-34M312-1A X 3/16	34	.884	.870	1.050	6F	.1875	.449	3/4	19/64	.624	6-40(2)
34M312-1A X 1/4	34	.884	.870	1.050	6F	.2500	.449	3/4	19/64	.624	8-32(2)
SAV-34M312-1A X 1/4	34	.884	.870	1.050	6F	.2500	.449	3/4	19/64	.624	8-32(2)
35M312-1A X 3/16	35	.910	.896	1.080	6F	.1875	.449	3/4	19/64	.650	6-40(2)
SAV-35M312-1A X 3/16	35	.910	.896	1.080	6F	.1875	.449	3/4	19/64	.650	6-40(2)
35M312-1A X 1/4	35	.910	.896	1.080	6F	.2500	.449	3/4	19/64	.650	8-32(2)
SAV-35M312-1A X 1/4	35	.910	.896	1.080	6F	.2500	.449	3/4	19/64	.650	8-32(2)
36M312-1A X 3/16	36	.936	.922	1.105	6F	.1875	.449	3/4	19/64	.676	6-40(2)
SAV-36M312-1A X 3/16	36	.936	.922	1.105	6F	.1875	.449	3/4	19/64	.676	6-40(2)
36M312-1A X 1/4	36	.936	.922	1.105	6F	.2500	.449	3/4	19/64	.676	8-32(2)
SAV-36M312-1A X 1/4	36	.936	.922	1.105	6F	.2500	.449	3/4	19/64	.676	8-32(2)
38M312-1A X 1/4	38	.988	.974	1.155	6F	.2500	.449	3/4	19/64	.728	8-32(2)
SAV-38M312-1A X 1/4	38	.988	.974	1.155	6F	.2500	.449	3/4	19/64	.728	8-32(2)
38M312-1A X 5/16	38	.988	.974	1.155	6F	.3125	.449	3/4	19/64	.728	8-32(2)
SAV-38M312-1A X 5/16	38	.988	.974	1.155	6F	.3125	.449	3/4	19/64	.728	8-32(2)
40M312-1A X 1/4	40	1.040	1.026	1.210	6F	.2500	.465	25/32	5/16	.754	8-32(2)
SAV-40M312-1A X 1/4	40	1.040	1.026	1.210	6F	.2500	.465	25/32	5/16	.754	8-32(2)
40M312-1A X 5/16	40	1.040	1.026	1.210	6F	.3125	.465	25/32	5/16	.754	8-32(2)
SAV-40M312-1A X 5/16	40	1.040	1.026	1.210	6F	.3125	.465	25/32	5/16	.754	8-32(2)
42M312-1A X 1/4	42	1.092	1.078	1.260	6F	.2500	.465	25/32	5/16	.806	8-32(2)
SAV-42M312-1A X 1/4	42	1.092	1.078	1.260	6F	.2500	.465	25/32	5/16	.806	8-32(2)
42M312-1A X 5/16	42	1.092	1.078	1.260	6F	.3125	.465	25/32	5/16	.806	8-32(2)
SAV-42M312-1A X 5/16	42	1.092	1.078	1.260	6F	.3125	.465	25/32	5/16	.806	8-32(2)
44M312-1A X 1/4	44	1.144	1.130	1.315	6F	.2500	.465	25/32	5/16	.858	8-32(2)
SAV-44M312-1A X 1/4	44	1.144	1.130	1.315	6F	.2500	.465	25/32	5/16	.858	8-32(2)

"SAV." in front of any standard timing pulley part # represents the Shaft-Saver version. Shaft-Saver pulleys have special setscrews that grip without damage to the shaft and allow easy pulley removal and realignment. For additional information, see our Shaft-Saver Engineering Section.

York also manufactures custom pulleys and complete assemblies
 email:support@york-ind.com web: www.york-ind.com



ALUMINUM WITH CLEAR ANODIZE (RoHS compliant)

FOR BELTS UP TO 5/16" WIDE

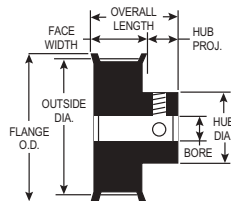

TYPE 6F

PART NUMBER	NO. OF GROOVES	PITCH DIA.	OUTSIDE DIA.	FLANGE O.D.	BORE (+.001) (-.000)	FACE WIDTH	OVERALL LENGTH	HUB PROJ.	HUB DIA.	SET SCREWS
44M312-1A X 5/16	44	1.144	1.130	1.315	6F	.3125	.465	25/32	5/16	.858 8-32(2)
SAV-44M312-1A X 5/16	44	1.144	1.130	1.315	6F	.3125	.465	25/32	5/16	.858 8-32(2)
45M312-1A X 1/4	45	1.170	1.156	1.340	6F	.2500	.465	25/32	5/16	.884 8-32(2)
SAV-45M312-1A X 1/4	45	1.170	1.156	1.340	6F	.2500	.465	25/32	5/16	.884 8-32(2)
45M312-1A X 5/16	45	1.170	1.156	1.340	6F	.3125	.465	25/32	5/16	.884 8-32(2)
SAV-45M312-1A X 5/16	45	1.170	1.156	1.340	6F	.3125	.465	25/32	5/16	.884 8-32(2)
48M312-1A X 1/4	48	1.248	1.234	1.420	6F	.2500	.465	25/32	5/16	.936 8-32(2)
SAV-48M312-1A X 1/4	48	1.248	1.234	1.420	6F	.2500	.465	25/32	5/16	.936 8-32(2)
48M312-1A X 5/16	48	1.248	1.234	1.420	6F	.3125	.465	25/32	5/16	.936 8-32(2)
SAV-48M312-1A X 5/16	48	1.248	1.234	1.420	6F	.3125	.465	25/32	5/16	.936 8-32(2)
50M312-1A X 1/4	50	1.300	1.286	1.470	6F	.2500	.465	25/32	5/16	.988 8-32(2)
SAV-50M312-1A X 1/4	50	1.300	1.286	1.470	6F	.2500	.465	25/32	5/16	.988 8-32(2)
50M312-1A X 5/16	50	1.300	1.286	1.470	6F	.3125	.465	25/32	5/16	.988 8-32(2)
SAV-50M312-1A X 5/16	50	1.300	1.286	1.470	6F	.3125	.465	25/32	5/16	.988 8-32(2)
54M312-1A X 1/4	54	1.404	1.390	1.575	6F	.2500	.465	25/32	5/16	1.066 8-32(2)
SAV-54M312-1A X 1/4	54	1.404	1.390	1.575	6F	.2500	.465	25/32	5/16	1.066 8-32(2)
54M312-1A X 5/16	54	1.404	1.390	1.575	6F	.3125	.465	25/32	5/16	1.066 8-32(2)
SAV-54M312-1A X 5/16	54	1.404	1.390	1.575	6F	.3125	.465	25/32	5/16	1.066 8-32(2)
60M312-1A X 1/4	60	1.560	1.546	1.730	6F	.2500	.465	25/32	5/16	1.222 8-32(2)
SAV-60M312-1A X 1/4	60	1.560	1.546	1.730	6F	.2500	.465	25/32	5/16	1.222 8-32(2)
60M312-1A X 5/16	60	1.560	1.546	1.730	6F	.3125	.465	25/32	5/16	1.222 8-32(2)
SAV-60M312-1A X 5/16	60	1.560	1.546	1.730	6F	.3125	.465	25/32	5/16	1.222 8-32(2)

“SAV-” in front of any standard timing pulley part # represents the Shaft-Saver version. Shaft-Saver pulleys have special setscrews that grip without damage to the shaft and allow easy pulley removal and realignment. For additional information, see our Shaft-Saver Engineering Section.

ALUMINUM WITH CLEAR ANODIZE (RoHS compliant)

FOR BELTS UP TO 5/16" WIDE

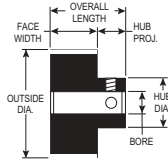

TYPE 6



PART NUMBER	NO. OF GROOVES	PITCH DIA.	OUTSIDE DIA.	TYPE	BORE (+.001) (-.000)	FACE WIDTH	OVERALL LENGTH	HUB PROJ.	HUB DIA.	SET SCREWS (2@90°)
20M312-2A X 3/16	20	.520	.506	6	.1875	1/2	7/8	3/8	.436	6-40
SAV-20M312-2A X 3/16	20	.520	.506	6	.1875	1/2	7/8	3/8	.436	6-40
20M312-2A X 1/4	20	.520	.506	6	.2500	1/2	7/8	3/8	.436	6-40
SAV-20M312-2A X 1/4	20	.520	.506	6	.2500	1/2	7/8	3/8	.436	6-40
24M312-2A X 3/16	24	.624	.610	6	.1875	1/2	7/8	3/8	.500	6-40
SAV-24M312-2A X 3/16	24	.624	.610	6	.1875	1/2	7/8	3/8	.500	6-40
24M312-2A X 1/4	24	.624	.610	6	.2500	1/2	7/8	3/8	.500	8-32
SAV-24M312-2A X 1/4	24	.624	.610	6	.2500	1/2	7/8	3/8	.500	8-32
30M312-2A X 1/4	30	.780	.766	6	.2500	1/2	7/8	3/8	.656	8-32
SAV-30M312-2A X 1/4	30	.780	.766	6	.2500	1/2	7/8	3/8	.656	8-32
40M312-2A X 1/4	40	1.040	1.026	6	.2500	1/2	7/8	3/8	.666	8-32
SAV-40M312-2A X 1/4	40	1.040	1.026	6	.2500	1/2	7/8	3/8	.666	8-32
45M312-2A X 1/4	45	1.170	1.156	6	.2500	1/2	7/8	3/8	.796	8-32
SAV-45M312-2A X 1/4	45	1.170	1.156	6	.2500	1/2	7/8	3/8	.796	8-32
50M312-2A X 1/4	50	1.300	1.286	6	.2500	1/2	7/8	3/8	.926	8-32
SAV-50M312-2A X 1/4	50	1.300	1.286	6	.2500	1/2	7/8	3/8	.926	8-32
50M312-2A X 5/16	50	1.300	1.286	6	.3125	1/2	7/8	3/8	.926	8-32
SAV-50M312-2A X 5/16	50	1.300	1.286	6	.3125	1/2	7/8	3/8	.926	8-32
60M312-2A X 1/4	60	1.560	1.546	6	.2500	1/2	7/8	3/8	1.187	8-32
SAV-60M312-2A X 1/4	60	1.560	1.546	6	.2500	1/2	7/8	3/8	1.187	8-32
60M312-2A X 5/16	60	1.560	1.546	6	.3125	1/2	7/8	3/8	1.187	8-32
SAV-60M312-2A X 5/16	60	1.560	1.546	6	.3125	1/2	7/8	3/8	1.187	8-32
70M312-2A X 1/4	70	1.820	1.806	6	.2500	1/2	7/8	3/8	1.150	8-32
SAV-70M312-2A X 1/4	70	1.820	1.806	6	.2500	1/2	7/8	3/8	1.150	8-32
70M312-2A X 5/16	70	1.820	1.806	6	.3125	1/2	7/8	3/8	1.150	10-32
SAV-70M312-2A X 5/16	70	1.820	1.806	6	.3125	1/2	7/8	3/8	1.150	10-32
72M312-2A X 1/4	72	1.872	1.858	6	.2500	1/2	7/8	3/8	1.202	8-32
SAV-72M312-2A X 1/4	72	1.872	1.858	6	.2500	1/2	7/8	3/8	1.202	8-32
72M312-2A X 3/8	72	1.872	1.858	6	.3750	1/2	7/8	3/8	1.202	10-32
SAV-72M312-2A X 3/8	72	1.872	1.858	6	.3750	1/2	7/8	3/8	1.202	10-32
75M312-2A X 1/4	75	1.950	1.936	6	.2500	1/2	7/8	3/8	1.266	8-32
SAV-75M312-2A X 1/4	75	1.950	1.936	6	.2500	1/2	7/8	3/8	1.266	8-32
75M312-2A X 3/8	75	1.950	1.936	6	.3750	1/2	7/8	3/8	1.266	10-32
SAV-75M312-2A X 3/8	75	1.950	1.936	6	.3750	1/2	7/8	3/8	1.266	10-32
80M312-2A X 1/4	80	2.080	2.066	6	.2500	1/2	7/8	3/8	1.396	8-32
SAV-80M312-2A X 1/4	80	2.080	2.066	6	.2500	1/2	7/8	3/8	1.396	8-32
80M312-2A X 3/8	80	2.080	2.066	6	.3750	1/2	7/8	3/8	1.396	10-32
SAV-80M312-2A X 3/8	80	2.080	2.066	6	.3750	1/2	7/8	3/8	1.396	10-32

“SAV-” in front of any standard timing pulley part # represents the Shaft-Saver version. Shaft-Saver pulleys have special setscrews that grip without damage to the shaft and allow easy pulley removal and realignment. For additional information, see our Shaft-Saver Engineering Section.

York also manufactures custom pulleys and complete assemblies
 email:support@york-ind.com web: www.york-ind.com



ALUMINUM WITH CLEAR ANODIZE (RoHS compliant)

FOR BELTS UP TO 5/16" WIDE

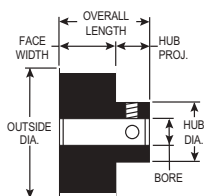

TYPE 6

PART NUMBER	NO. OF GROOVES	PITCH DIA.	OUTSIDE DIA.	TYPE	BORE (+.001) (-.000)	FACE WIDTH	OVERALL LENGTH	HUB PROJ.	HUB DIA.	SET SCREWS (2@90°)
84M312-2A X 1/4	84	2.184	2.170	6	.2500	1/2	7/8	3/8	1.500	8-32
SAV-84M312-2A X 1/4	84	2.184	2.170	6	.2500	1/2	7/8	3/8	1.500	8-32
84M312-2A X 3/8	84	2.184	2.170	6	.3750	1/2	7/8	3/8	1.500	10-32
SAV-84M312-2A X 3/8	84	2.184	2.170	6	.3750	1/2	7/8	3/8	1.500	10-32
88M312-2A X 1/4	88	2.288	2.274	6	.2500	1/2	7/8	3/8	1.500	8-32
SAV-88M312-2A X 1/4	88	2.288	2.274	6	.2500	1/2	7/8	3/8	1.500	8-32
88M312-2A X 3/8	88	2.288	2.274	6	.3750	1/2	7/8	3/8	1.500	10-32
SAV-88M312-2A X 3/8	88	2.288	2.274	6	.3750	1/2	7/8	3/8	1.500	10-32
90M312-2A X 1/4	90	2.340	2.326	6	.2500	1/2	7/8	3/8	1.500	8-32
SAV-90M312-2A X 1/4	90	2.340	2.326	6	.2500	1/2	7/8	3/8	1.500	8-32
90M312-2A X 3/8	90	2.340	2.326	6	.3750	1/2	7/8	3/8	1.500	10-32
SAV-90M312-2A X 3/8	90	2.340	2.326	6	.3750	1/2	7/8	3/8	1.500	10-32
96M312-2A X 1/4	96	2.496	2.482	6	.2500	1/2	7/8	3/8	1.500	8-32
SAV-96M312-2A X 1/4	96	2.496	2.482	6	.2500	1/2	7/8	3/8	1.500	8-32
96M312-2A X 3/8	96	2.496	2.482	6	.3750	1/2	7/8	3/8	1.500	10-32
SAV-96M312-2A X 3/8	96	2.496	2.482	6	.3750	1/2	7/8	3/8	1.500	10-32
98M312-2A X 1/4	98	2.548	2.534	6	.2500	1/2	7/8	3/8	1.500	8-32
SAV-98M312-2A X 1/4	98	2.548	2.534	6	.2500	1/2	7/8	3/8	1.500	8-32
98M312-2A X 3/8	98	2.548	2.534	6	.3750	1/2	7/8	3/8	1.500	10-32
SAV-98M312-2A X 3/8	98	2.548	2.534	6	.3750	1/2	7/8	3/8	1.500	10-32
100M312-2A X 5/16	100	2.600	2.586	6	.3125	1/2	7/8	3/8	1.500	8-32
SAV-100M312-2A X 5/16	100	2.600	2.586	6	.3125	1/2	7/8	3/8	1.500	8-32
100M312-2A X 3/8	100	2.600	2.586	6	.3750	1/2	7/8	3/8	1.500	10-32
SAV-100M312-2A X 3/8	100	2.600	2.586	6	.3750	1/2	7/8	3/8	1.500	10-32
108M312-2A X 5/16	108	2.808	2.794	6	.3125	1/2	7/8	3/8	1.500	8-32
SAV-108M312-2A X 5/16	108	2.808	2.794	6	.3125	1/2	7/8	3/8	1.500	8-32
108M312-2A X 3/8	108	2.808	2.794	6	.3750	1/2	7/8	3/8	1.500	10-32
SAV-108M312-2A X 3/8	108	2.808	2.794	6	.3750	1/2	7/8	3/8	1.500	10-32
110M312-2A X 3/8	110	2.860	2.846	6	.3750	1/2	7/8	3/8	1.500	10-32
SAV-110M312-2A X 3/8	110	2.860	2.846	6	.3750	1/2	7/8	3/8	1.500	10-32
120M312-2A X 5/16	120	3.120	3.106	6	.3125	1/2	7/8	3/8	1.500	8-32
SAV-120M312-2A X 5/16	120	3.120	3.106	6	.3125	1/2	7/8	3/8	1.500	8-32
120M312-2A X 3/8	120	3.120	3.106	6	.3750	1/2	7/8	3/8	1.500	10-32
SAV-120M312-2A X 3/8	120	3.120	3.106	6	.3750	1/2	7/8	3/8	1.500	10-32
130M312-2A X 3/8	130	3.380	3.366	6	.3750	1/2	7/8	3/8	1.750	10-32
SAV-130M312-2A X 3/8	130	3.380	3.366	6	.3750	1/2	7/8	3/8	1.750	10-32
140M312-2A X 3/8	140	3.640	3.626	6	.3750	1/2	7/8	3/8	1.750	10-32
SAV-140M312-2A X 3/8	140	3.640	3.626	6	.3750	1/2	7/8	3/8	1.750	10-32
150M312-2A X 3/8	150	3.900	3.886	6	.3750	1/2	7/8	3/8	2.000	10-32
SAV-150M312-2A X 3/8	150	3.900	3.886	6	.3750	1/2	7/8	3/8	2.000	10-32

"SAV-" in front of any standard timing pulley part # represents the Shaft-Saver version. Shaft-Saver pulleys have special setscrews that grip without damage to the shaft and allow easy pulley removal and realignment. For additional information, see our Shaft-Saver Engineering Section.

TIMING PULLEY STOCK

.0816" (40 D.P.) PITCH

ALUMINUM 6061-T6 (RoHS compliant)

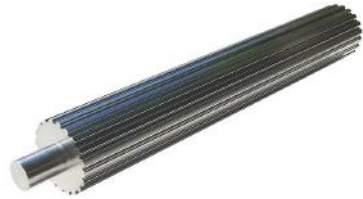
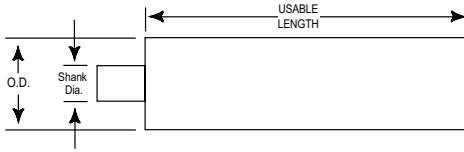

PART NUMBER	NO. OF GROOVES	PITCH DIA.	OUTSIDE DIA.	SHANK DIA.	USEABLE LENGTH
10M-P-2A	10	.260	.246	5/16	2"
11M-P-2A	11	.286	.272	5/16	2"
12M-P-2A	12	.312	.298	5/16	2"
13M-P-2A	13	.338	.324	3/8	2"
14M-P-3A	14	.364	.350	3/8	3"
15M-P-3A	15	.390	.376	7/16	3"
16M-P-3A	16	.416	.402	7/16	3"
17M-P-3A	17	.442	.428	7/16	3"
18M-P-3A	18	.468	.454	1/2	3"
19M-P-3A	19	.494	.480	1/2	3"
20M-P-4A	20	.520	.506	3/8	4"
21M-P-4A	21	.546	.532	3/8	4"
22M-P-4A	22	.572	.558	3/8	4"
23M-P-4A	23	.598	.584	3/8	4"
24M-P-5A	24	.624	.610	1/2	5"
25M-P-5A	25	.650	.636	1/2	5"
26M-P-5A	26	.676	.662	1/2	5"
27M-P-5A	27	.702	.688	1/2	5"
28M-P-5A	28	.728	.714	1/2	5"
29M-P-5A	29	.754	.740	1/2	5"
30M-P-6A	30	.780	.766	1/2	6"
31M-P-6A	31	.806	.792	1/2	6"
32M-P-6A	32	.832	.818	1/2	6"
33M-P-6A	33	.858	.844	1/2	6"
34M-P-6A	34	.884	.870	1/2	6"
35M-P-6A	35	.910	.896	1/2	6"
36M-P-6A	36	.936	.922	1/2	6"
37M-P-6A	37	.962	.948	1/2	6"
38M-P-6A	38	.988	.974	1/2	6"
39M-P-6A	39	1.014	1.000	1/2	6"

York also manufactures custom pulleys and complete assemblies
 email: support@york-ind.com web: www.york-ind.com



ALUMINUM 6061-T6 (RoHS compliant)

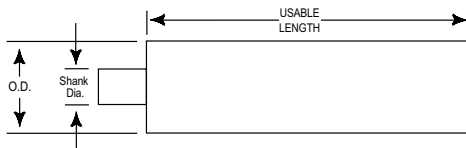

PART NUMBER	NO. OF GROOVES	PITCH DIA.	OUTSIDE DIA.	SHANK DIA.	USEABLE LENGTH
40M-P-7A	40	1.040	1.026	1/2	7"
42M-P-7A	42	1.092	1.078	1/2	7"
44M-P-7A	44	1.144	1.130	1/2	7"
45M-P-7A	45	1.170	1.156	1/2	7"
48M-P-7A	48	1.248	1.234	1/2	7"
50M-P-7A	50	1.300	1.286	1/2	7"
51M-P-7A	51	1.326	1.312	1/2	7"
52M-P-7A	52	1.352	1.338	1/2	7"
54M-P-7A	54	1.404	1.390	1/2	7"
55M-P-7A	55	1.430	1.416	1/2	7"
56M-P-7A	56	1.456	1.442	1/2	7"
57M-P-7A	57	1.482	1.468	1/2	7"
60M-P-8A	60	1.560	1.546	1/2	8"
64M-P-8A	64	1.664	1.650	1/2	8"
65M-P-8A	65	1.690	1.676	1/2	8"
66M-P-8A	66	1.716	1.702	1/2	8"
70M-P-8A	70	1.820	1.806	1/2	8"
72M-P-8A	72	1.872	1.858	1/2	8"
75M-P-8A	75	1.950	1.936	1/2	8"
80M-P-8A	80	2.080	2.066	3/4	8"
82M-P-8A	82	2.132	2.118	3/4	8"
84M-P-8A	84	2.184	2.170	3/4	8"
88M-P-8A	88	2.288	2.274	3/4	8"
90M-P-8A	90	2.340	2.326	3/4	8"
96M-P-8A	96	2.496	2.482	3/4	8"
98M-P-8A	98	2.548	2.534	3/4	8"
100M-P-8A	100	2.600	2.586	3/4	8"
102M-P-8A	102	2.652	2.638	3/4	8"
108M-P-8A	108	2.808	2.794	3/4	8"
110M-P-8A	110	2.860	2.846	3/4	8"
120M-P-8A	120	3.120	3.106	3/4	8"
130M-P-8A	130	3.380	3.366	3/4	8"
140M-P-8A	140	3.640	3.626	3/4	8"
150M-P-8A	150	3.900	3.886	3/4	8"

YORK

ISO 9001: 2008 Registered

303 Nassau Blvd., Garden City Park, NY 11040

Tel: 1-800 354 8466 Fax: 1-800 354 8485

PULLEY FLANGES

.0816" (40 D.P.) PITCH

ALUMINUM (RoHS compliant)

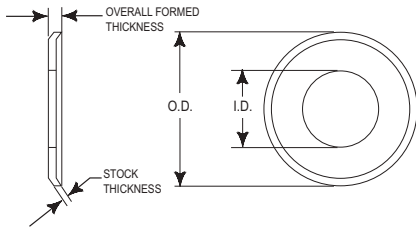

PART NUMBER	INSIDE DIA.	OUTSIDE DIA.	STOCK THICKNESS	OVERALL FORMED THICKNESS
10M-F1A	.188	.425	.025	.045
11M-F1A	.214	.450	.025	.045
12M-F1A	.218	.480	.025	.045
13M-F1A	.244	.505	.025	.045
14M-F1A	.270	.530	.025	.045
15M-F1A	.296	.555	.025	.045
16M-F1A	.322	.580	.025	.045
18M-F1A	.374	.635	.032	.052
20M-F1A	.426	.685	.032	.052
21M-F1A	.452	.710	.032	.052
22M-F1A	.452	.740	.032	.052
24M-F1A	.504	.790	.032	.052
25M-F1A	.530	.815	.032	.052
26M-F1A	.556	.840	.032	.052
28M-F1A	.574	.895	.032	.052
30M-F1A	.626	.945	.032	.052
32M-F1A	.678	1.000	.032	.052
33M-F1A	.704	1.025	.032	.052
34M-F1A	.722	1.050	.032	.052
35M-F1A	.748	1.080	.032	.052
36M-F1A	.774	1.105	.032	.052
38M-F1A	.826	1.155	.032	.052
40M-F1A	.874	1.210	.040	.060
42M-F1A	.926	1.260	.040	.060
44M-F1A	.978	1.315	.040	.060
45M-F1A	1.004	1.340	.040	.060
48M-F1A	1.058	1.420	.040	.060
50M-F1A	1.110	1.470	.040	.060
54M-F1A	1.200	1.575	.040	.060
60M-F1A	1.356	1.730	.040	.060

York also manufactures custom pulleys and complete assemblies
 email: support@york-ind.com web: www.york-ind.com



URETHANE, Polyester Cord (RoHS compliant)

If you don't see the belt you need – call York!

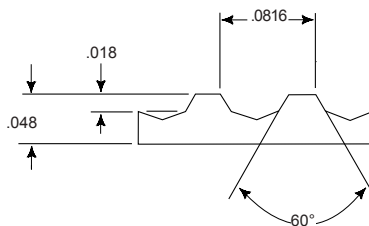

BELT NUMBER	1/8"	3/16"	1/4"	5/16"	PITCH LENGTH	NO. OF TEETH	BELT NUMBER	1/8"	3/16"	1/4"	5/16"	PITCH LENGTH	NO. OF TEETH
25T81-P	1/8	3/16	1/4	5/16	2.040	25	91T81-P	1/8	3/16	1/4	5/16	7.426	91
30T81-P	1/8	3/16	1/4	5/16	2.448	30	94T81-P	1/8	3/16	1/4	5/16	7.670	94
33T81-P	1/8	3/16	1/4	5/16	2.693	33	95T81-P	1/8	3/16	1/4	5/16	7.752	95
40T81-P	1/8	3/16	1/4	5/16	3.264	40	96T81-P	1/8	3/16	1/4	5/16	7.834	96
44T81-P	1/8	3/16	1/4	5/16	3.590	44	97T81-P	1/8	3/16	1/4	5/16	7.915	97
45T81-P	1/8	3/16	1/4	5/16	3.672	45	98T81-P	1/8	3/16	1/4	5/16	7.997	98
48T81-P	1/8	3/16	1/4	5/16	3.917	48	100T81-P	1/8	3/16	1/4	5/16	8.160	100
50T81-P	1/8	3/16	1/4	5/16	4.080	50	102T81-P	1/8	3/16	1/4	5/16	8.323	102
51T81-P	1/8	3/16	1/4	5/16	4.162	51	105T81-P	1/8	3/16	1/4	5/16	8.568	105
52T81-P	1/8	3/16	1/4	5/16	4.243	52	109T81-P	1/8	3/16	1/4	5/16	8.894	109
53T81-P	1/8	3/16	1/4	5/16	4.325	53	110T81-P	1/8	3/16	1/4	5/16	8.976	110
55T81-P	1/8	3/16	1/4	5/16	4.488	55	114T81-P	1/8	3/16	1/4	5/16	9.302	114
56T81-P	1/8	3/16	1/4	5/16	4.570	56	115T81-P	1/8	3/16	1/4	5/16	9.384	115
57T81-P	1/8	3/16	1/4	5/16	4.651	57	116T81-P	1/8	3/16	1/4	5/16	9.466	116
58T81-P	1/8	3/16	1/4	5/16	4.733	58	118T81-P	1/8	3/16	1/4	5/16	9.629	118
60T81-P	1/8	3/16	1/4	5/16	4.896	60	119T81-P	1/8	3/16	1/4	5/16	9.710	119
61T81-P	1/8	3/16	1/4	5/16	4.978	61	120T81-P	1/8	3/16	1/4	5/16	9.792	120
64T81-P	1/8	3/16	1/4	5/16	5.222	64	122T81-P	1/8	3/16	1/4	5/16	9.955	122
65T81-P	1/8	3/16	1/4	5/16	5.304	65	123T81-P	1/8	3/16	1/4	5/16	10.037	123
69T81-P	1/8	3/16	1/4	5/16	5.630	69	125T81-P	1/8	3/16	1/4	5/16	10.200	125
70T81-P	1/8	3/16	1/4	5/16	5.712	70	130T81-P	1/8	3/16	1/4	5/16	10.608	130
71T81-P	1/8	3/16	1/4	5/16	5.794	71	131T81-P	1/8	3/16	1/4	5/16	10.690	131
72T81-P	1/8	3/16	1/4	5/16	5.875	72	132T81-P	1/8	3/16	1/4	5/16	10.771	132
73T81-P	1/8	3/16	1/4	5/16	5.957	73	134T81-P	1/8	3/16	1/4	5/16	10.934	134
74T81-P	1/8	3/16	1/4	5/16	6.038	74	135T81-P	1/8	3/16	1/4	5/16	11.016	135
75T81-P	1/8	3/16	1/4	5/16	6.120	75	139T81-P	1/8	3/16	1/4	5/16	11.342	139
76T81-P	1/8	3/16	1/4	5/16	6.202	76	140T81-P	1/8	3/16	1/4	5/16	11.424	140
77T81-P	1/8	3/16	1/4	5/16	6.283	77	143T81-P	1/8	3/16	1/4	5/16	11.669	143
80T81-P	1/8	3/16	1/4	5/16	6.528	80	144T81-P	1/8	3/16	1/4	5/16	11.750	144
81T81-P	1/8	3/16	1/4	5/16	6.610	81	145T81-P	1/8	3/16	1/4	5/16	11.832	145
84T81-P	1/8	3/16	1/4	5/16	6.854	84	147T81-P	1/8	3/16	1/4	5/16	11.995	147
85T81-P	1/8	3/16	1/4	5/16	6.936	85	149T81-P	1/8	3/16	1/4	5/16	12.158	149
89T81-P	1/8	3/16	1/4	5/16	7.262	89	150T81-P	1/8	3/16	1/4	5/16	12.240	150
90T81-P	1/8	3/16	1/4	5/16	7.344	90	151T81-P	1/8	3/16	1/4	5/16	12.322	151

TIMING BELTS

.0816" (40 D.P.) PITCH

URETHANE, Polyester Cord (RoHS compliant)

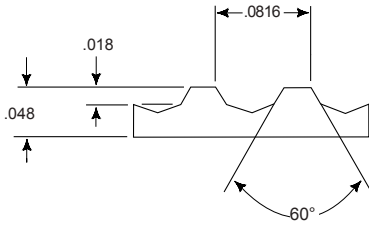

BELT NUMBER	1/8"	WIDTHS			PITCH LENGTH	NO. OF TEETH	BELT NUMBER	1/8"	WIDTHS			PITCH LENGTH	NO. OF TEETH
		3/16"	1/4"	5/16"				3/16"	1/4"	5/16"			
152T81-P	1/8	3/16	1/4	5/16	12.403	152	255T81-P	1/8	3/16	1/4	5/16	20.808	255
153T81-P	1/8	3/16	1/4	5/16	12.485	153	256T81-P	1/8	3/16	1/4	5/16	20.890	256
154T81-P	1/8	3/16	1/4	5/16	12.566	154	257T81-P	1/8	3/16	1/4	5/16	20.971	257
155T81-P	1/8	3/16	1/4	5/16	12.648	155	258T81-P	1/8	3/16	1/4	5/16	21.053	258
159T81-P	1/8	3/16	1/4	5/16	12.974	159	260T81-P	1/8	3/16	1/4	5/16	21.216	260
160T81-P	1/8	3/16	1/4	5/16	13.056	160	264T81-P	1/8	3/16	1/4	5/16	21.542	264
162T81-P	1/8	3/16	1/4	5/16	13.219	162	265T81-P	1/8	3/16	1/4	5/16	21.624	265
163T81-P	1/8	3/16	1/4	5/16	13.301	163	270T81-P	1/8	3/16	1/4	5/16	22.032	270
165T81-P	1/8	3/16	1/4	5/16	13.464	165	275T81-P	1/8	3/16	1/4	5/16	22.440	275
170T81-P	1/8	3/16	1/4	5/16	13.872	170	280T81-P	1/8	3/16	1/4	5/16	22.848	280
175T81-P	1/8	3/16	1/4	5/16	14.280	175	281T81-P	1/8	3/16	1/4	5/16	22.930	281
178T81-P	1/8	3/16	1/4	5/16	14.525	178	285T81-P	1/8	3/16	1/4	5/16	23.256	285
180T81-P	1/8	3/16	1/4	5/16	14.688	180	290T81-P	1/8	3/16	1/4	5/16	23.664	290
185T81-P	1/8	3/16	1/4	5/16	15.096	185	295T81-P	1/8	3/16	1/4	5/16	24.072	295
190T81-P	1/8	3/16	1/4	5/16	15.504	190	300T81-P	1/8	3/16	1/4	5/16	24.480	300
192T81-P	1/8	3/16	1/4	5/16	15.667	192	310T81-P	1/8	3/16	1/4	5/16	25.296	310
193T81-P	1/8	3/16	1/4	5/16	15.749	193	320T81-P	1/8	3/16	1/4	5/16	26.112	320
195T81-P	1/8	3/16	1/4	5/16	15.912	195	324T81-P	1/8	3/16	1/4	5/16	26.438	324
200T81-P	1/8	3/16	1/4	5/16	16.320	200	330T81-P	1/8	3/16	1/4	5/16	26.928	330
205T81-P	1/8	3/16	1/4	5/16	16.728	205	340T81-P	1/8	3/16	1/4	5/16	27.744	340
208T81-P	1/8	3/16	1/4	5/16	16.973	208	350T81-P	1/8	3/16	1/4	5/16	28.560	350
210T81-P	1/8	3/16	1/4	5/16	17.136	210	360T81-P	1/8	3/16	1/4	5/16	29.376	360
214T81-P	1/8	3/16	1/4	5/16	17.462	214	369T81-P	1/8	3/16	1/4	5/16	30.110	369
215T81-P	1/8	3/16	1/4	5/16	17.544	215	370T81-P	1/8	3/16	1/4	5/16	30.192	370
220T81-P	1/8	3/16	1/4	5/16	17.952	220	380T81-P	1/8	3/16	1/4	5/16	31.008	380
222T81-P	1/8	3/16	1/4	5/16	18.115	222	390T81-P	1/8	3/16	1/4	5/16	31.824	390
225T81-P	1/8	3/16	1/4	5/16	18.360	225	392T81-P	1/8	3/16	1/4	5/16	31.987	392
230T81-P	1/8	3/16	1/4	5/16	18.768	230	400T81-P	1/8	3/16	1/4	5/16	32.640	400
235T81-P	1/8	3/16	1/4	5/16	19.176	235	408T81-P	1/8	3/16	1/4	5/16	33.293	408
240T81-P	1/8	3/16	1/4	5/16	19.584	240	423T81-P	1/8	3/16	1/4	5/16	34.517	423
245T81-P	1/8	3/16	1/4	5/16	19.992	245	436T81-P	1/8	3/16	1/4	5/16	35.578	436
250T81-P	1/8	3/16	1/4	5/16	20.400	250	472T81-P	1/8	3/16	1/4	5/16	38.515	472
252T81-P	1/8	3/16	1/4	5/16	20.563	252	535T81-P	1/8	3/16	1/4	5/16	43.656	535

If you don't see the belt you need – call York!

York also manufactures custom pulleys and complete assemblies
 email:support@york-ind.com web: www.york-ind.com



URETHANE, Kevlar Cord (RoHS compliant)

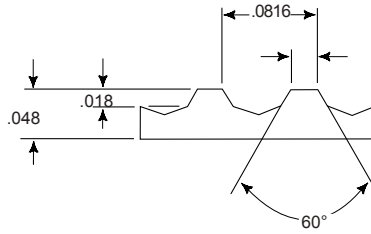

BELT NUMBER	1/8"	WIDTHS			PITCH LENGTH	NO. OF TEETH	BELT NUMBER	1/8"	WIDTHS			PITCH LENGTH	NO. OF TEETH
		3/16"	1/4"	5/16"					3/16"	1/4"	5/16"		
25T81-K	1/8	3/16	1/4	5/16	2.040	25	89T81-K	1/8	3/16	1/4	5/16	7.262	89
30T81-K	1/8	3/16	1/4	5/16	2.448	30	90T81-K	1/8	3/16	1/4	5/16	7.344	90
33T81-K	1/8	3/16	1/4	5/16	2.693	33	91T81-K	1/8	3/16	1/4	5/16	7.426	91
40T81-K	1/8	3/16	1/4	5/16	3.264	40	94T81-K	1/8	3/16	1/4	5/16	7.670	94
44T81-K	1/8	3/16	1/4	5/16	3.590	44	95T81-K	1/8	3/16	1/4	5/16	7.752	95
45T81-K	1/8	3/16	1/4	5/16	3.672	45	96T81-K	1/8	3/16	1/4	5/16	7.834	96
48T81-K	1/8	3/16	1/4	5/16	3.917	48	97T81-K	1/8	3/16	1/4	5/16	7.915	97
50T81-K	1/8	3/16	1/4	5/16	4.080	50	98T81-K	1/8	3/16	1/4	5/16	7.997	98
51T81-K	1/8	3/16	1/4	5/16	4.162	51	100T81-K	1/8	3/16	1/4	5/16	8.160	100
52T81-K	1/8	3/16	1/4	5/16	4.243	52	102T81-K	1/8	3/16	1/4	5/16	8.323	102
53T81-K	1/8	3/16	1/4	5/16	4.325	53	105T81-K	1/8	3/16	1/4	5/16	8.568	105
55T81-K	1/8	3/16	1/4	5/16	4.488	55	109T81-K	1/8	3/16	1/4	5/16	8.894	109
56T81-K	1/8	3/16	1/4	5/16	4.570	56	110T81-K	1/8	3/16	1/4	5/16	8.976	110
57T81-K	1/8	3/16	1/4	5/16	4.651	57	114T81-K	1/8	3/16	1/4	5/16	9.302	114
58T81-K	1/8	3/16	1/4	5/16	4.733	58	115T81-K	1/8	3/16	1/4	5/16	9.384	115
60T81-K	1/8	3/16	1/4	5/16	4.896	60	116T81-K	1/8	3/16	1/4	5/16	9.466	116
61T81-K	1/8	3/16	1/4	5/16	4.978	61	118T81-K	1/8	3/16	1/4	5/16	9.629	118
64T81-K	1/8	3/16	1/4	5/16	5.222	64	119T81-K	1/8	3/16	1/4	5/16	9.710	119
65T81-K	1/8	3/16	1/4	5/16	5.304	65	120T81-K	1/8	3/16	1/4	5/16	9.792	120
69T81-K	1/8	3/16	1/4	5/16	5.630	69	122T81-K	1/8	3/16	1/4	5/16	9.955	122
70T81-K	1/8	3/16	1/4	5/16	5.712	70	123T81-K	1/8	3/16	1/4	5/16	10.037	123
71T81-K	1/8	3/16	1/4	5/16	5.794	71	125T81-K	1/8	3/16	1/4	5/16	10.200	125
72T81-K	1/8	3/16	1/4	5/16	5.875	72	130T81-K	1/8	3/16	1/4	5/16	10.608	130
73T81-K	1/8	3/16	1/4	5/16	5.957	73	131T81-K	1/8	3/16	1/4	5/16	10.690	131
74T81-K	1/8	3/16	1/4	5/16	6.038	74	132T81-K	1/8	3/16	1/4	5/16	10.771	132
75T81-K	1/8	3/16	1/4	5/16	6.120	75	134T81-K	1/8	3/16	1/4	5/16	10.934	134
76T81-K	1/8	3/16	1/4	5/16	6.202	76	135T81-K	1/8	3/16	1/4	5/16	11.016	135
77T81-K	1/8	3/16	1/4	5/16	6.283	77	139T81-K	1/8	3/16	1/4	5/16	11.342	139
80T81-K	1/8	3/16	1/4	5/16	6.528	80	140T81-K	1/8	3/16	1/4	5/16	11.424	140
81T81-K	1/8	3/16	1/4	5/16	6.610	81	143T81-K	1/8	3/16	1/4	5/16	11.669	143
84T81-K	1/8	3/16	1/4	5/16	6.854	84	144T81-K	1/8	3/16	1/4	5/16	11.750	144
85T81-K	1/8	3/16	1/4	5/16	6.936	85	145T81-K	1/8	3/16	1/4	5/16	11.832	145

If you don't see the belt you need – call York!

YORK

ISO 9001: 2008 Registered

303 Nassau Blvd., Garden City Park, NY 11040

Tel: 1-800 354 8466 Fax: 1-800 354 8485

TIMING BELTS

.0816" (40 D.P.) PITCH

URETHANE, Kevlar Cord (RoHS compliant)

If you don't see the belt you need – call York!

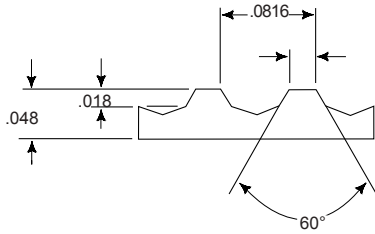

BELT NUMBER	1/8"	WIDTHS		PITCH LENGTH	NO. OF TEETH	BELT NUMBER	1/8"	WIDTHS		PITCH LENGTH	NO. OF TEETH	
		3/16"	1/4"					3/16"	1/4"			
147T81-K	1/8	3/16	1/4	5/16	11.995	147	1/8	3/16	1/4	5/16	20.563	252
149T81-K	1/8	3/16	1/4	5/16	12.158	149	1/8	3/16	1/4	5/16	20.808	255
150T81-K	1/8	3/16	1/4	5/16	12.240	150	1/8	3/16	1/4	5/16	20.890	256
151T81-K	1/8	3/16	1/4	5/16	12.322	151	1/8	3/16	1/4	5/16	20.971	257
152T81-K	1/8	3/16	1/4	5/16	12.403	152	1/8	3/16	1/4	5/16	21.053	258
153T81-K	1/8	3/16	1/4	5/16	12.485	153	1/8	3/16	1/4	5/16	21.216	260
154T81-K	1/8	3/16	1/4	5/16	12.566	154	1/8	3/16	1/4	5/16	21.542	264
155T81-K	1/8	3/16	1/4	5/16	12.648	155	1/8	3/16	1/4	5/16	21.624	265
159T81-K	1/8	3/16	1/4	5/16	12.974	159	1/8	3/16	1/4	5/16	22.032	270
160T81-K	1/8	3/16	1/4	5/16	13.056	160	1/8	3/16	1/4	5/16	22.440	275
162T81-K	1/8	3/16	1/4	5/16	13.219	162	1/8	3/16	1/4	5/16	22.848	280
163T81-K	1/8	3/16	1/4	5/16	13.301	163	1/8	3/16	1/4	5/16	23.256	285
165T81-K	1/8	3/16	1/4	5/16	13.464	165	1/8	3/16	1/4	5/16	23.664	290
170T81-K	1/8	3/16	1/4	5/16	13.872	170	1/8	3/16	1/4	5/16	24.072	295
175T81-K	1/8	3/16	1/4	5/16	14.280	175	1/8	3/16	1/4	5/16	24.480	300
178T81-K	1/8	3/16	1/4	5/16	14.525	178	1/8	3/16	1/4	5/16	25.296	310
180T81-K	1/8	3/16	1/4	5/16	14.688	180	1/8	3/16	1/4	5/16	26.112	320
185T81-K	1/8	3/16	1/4	5/16	15.096	185	1/8	3/16	1/4	5/16	26.438	324
190T81-K	1/8	3/16	1/4	5/16	15.504	190	1/8	3/16	1/4	5/16	26.928	330
195T81-K	1/8	3/16	1/4	5/16	15.912	195	1/8	3/16	1/4	5/16	27.744	340
200T81-K	1/8	3/16	1/4	5/16	16.320	200	1/8	3/16	1/4	5/16	28.560	350
205T81-K	1/8	3/16	1/4	5/16	16.728	205	1/8	3/16	1/4	5/16	29.376	360
208T81-K	1/8	3/16	1/4	5/16	16.973	208	1/8	3/16	1/4	5/16	30.110	369
210T81-K	1/8	3/16	1/4	5/16	17.136	210	1/8	3/16	1/4	5/16	30.192	370
214T81-K	1/8	3/16	1/4	5/16	17.462	214	1/8	3/16	1/4	5/16	31.008	380
215T81-K	1/8	3/16	1/4	5/16	17.544	215	1/8	3/16	1/4	5/16	31.824	390
220T81-K	1/8	3/16	1/4	5/16	17.952	220	1/8	3/16	1/4	5/16	31.987	392
222T81-K	1/8	3/16	1/4	5/16	18.115	222	1/8	3/16	1/4	5/16	32.640	400
225T81-K	1/8	3/16	1/4	5/16	18.360	225	1/8	3/16	1/4	5/16	33.293	408
230T81-K	1/8	3/16	1/4	5/16	18.768	230	1/8	3/16	1/4	5/16	34.517	423
235T81-K	1/8	3/16	1/4	5/16	19.176	235	1/8	3/16	1/4	5/16	35.578	436
240T81-K	1/8	3/16	1/4	5/16	19.584	240	1/8	3/16	1/4	5/16	38.515	472
245T81-K	1/8	3/16	1/4	5/16	19.992	245	1/8	3/16	1/4	5/16	43.656	535
250T81-K	1/8	3/16	1/4	5/16	20.400	250						

York also manufactures custom pulleys and complete assemblies
 email:support@york-ind.com web: www.york-ind.com





3MM HTD



3MM HTD

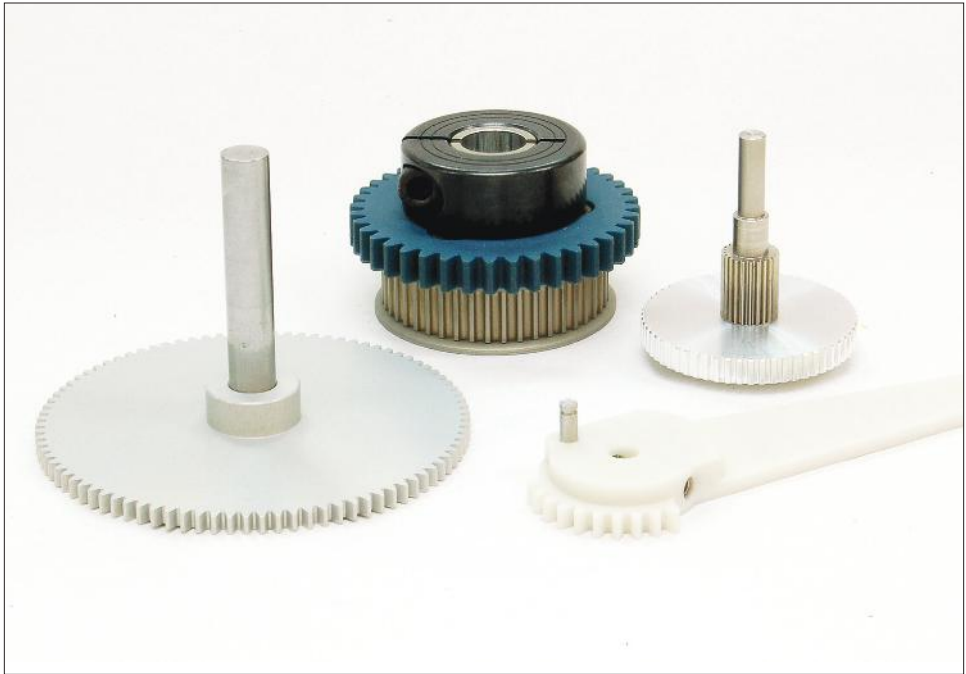

ALUMINUM WITH CLEAR ANODIZE (RoHS compliant)

FOR BELTS UP TO 6MM WIDE

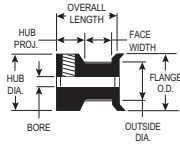

TYPE 6FC

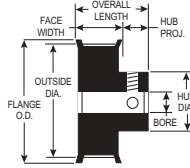

TYPE 6F

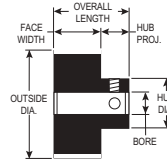

TYPE 6



PART NUMBER	NO. OF GROOVES	PITCH DIA.	OUTSIDE DIA.	FLANGE O.D.	TYPE	BORE (+.001 / -.000)	FACE WIDTH	OVERALL LENGTH	HUB DIA.	SET SCREWS
10-3M-06 X 1/8	10	.376	.346	.505	6FC	.1250	.282	9/16	.505	4-40(1)
SAV-10-3M-06 X 1/8	10	.376	.346	.505	6FC	.1250	.282	9/16	.505	4-40(1)
12-3M-06 X 3/16	12	.451	.421	.580	6FC	.1875	.282	9/16	.580	6-40(1)
SAV-12-3M-06 X 3/16	12	.451	.421	.580	6FC	.1875	.282	9/16	.580	6-40(1)
14-3M-06 X 3/16	14	.526	.496	.635	6FC	.1875	.282	9/16	.635	6-40(2)
SAV-14-3M-06 X 3/16	14	.526	.496	.635	6FC	.1875	.282	9/16	.635	6-40(2)
15-3M-06 X 3/16	15	.564	.534	.685	6FC	.1875	.282	9/16	.685	6-40(2)
SAV-15-3M-06 X 3/16	15	.564	.534	.685	6FC	.1875	.282	9/16	.685	6-40(2)
16-3M-06 X 3/16	16	.602	.572	.710	6FC	.1875	.282	9/16	.710	6-40(2)
SAV-16-3M-06 X 3/16	16	.602	.572	.710	6FC	.1875	.282	9/16	.710	6-40(2)
17-3M-06 X 3/16	17	.639	.609	.740	6FC	.1875	.282	9/16	.740	6-40(2)
SAV-17-3M-06 X 3/16	17	.639	.609	.740	6FC	.1875	.282	9/16	.740	6-40(2)
18-3M-06 X 1/4	18	.677	.647	.790	6F	.2500	.386	11/16	.442	8-32(2)
SAV-18-3M-06 X 1/4	18	.677	.647	.790	6F	.2500	.386	11/16	.442	8-32(2)
19-3M-06 X 1/4	19	.714	.684	.827	6F	.2500	.386	11/16	.468	8-32(2)
SAV-19-3M-06 X 1/4	19	.714	.684	.827	6F	.2500	.386	11/16	.468	8-32(2)
20-3M-06 X 1/4	20	.752	.722	.895	6F	.2500	.386	11/16	.500	8-32(2)
SAV-20-3M-06 X 1/4	20	.752	.722	.895	6F	.2500	.386	11/16	.500	8-32(2)
22-3M-06 X 1/4	22	.827	.797	.945	6F	.2500	.386	11/16	.562	8-32(2)
SAV-22-3M-06 X 1/4	22	.827	.797	.945	6F	.2500	.386	11/16	.562	8-32(2)
24-3M-06 X 1/4	24	.902	.872	1.025	6F	.2500	.386	11/16	.625	8-32(2)
SAV-24-3M-06 X 1/4	24	.902	.872	1.025	6F	.2500	.386	11/16	.625	8-32(2)
26-3M-06 X 1/4	26	.977	.947	1.105	6F	.2500	.386	11/16	.625	8-32(2)
SAV-26-3M-06 X 1/4	26	.977	.947	1.105	6F	.2500	.386	11/16	.625	8-32(2)
28-3M-06 X 1/4	28	1.053	1.023	1.173	6F	.2500	.386	11/16	.701	8-32(2)
SAV-28-3M-06 X 1/4	28	1.053	1.023	1.173	6F	.2500	.386	11/16	.701	8-32(2)
30-3M-06 X 1/4	30	1.128	1.098	1.250	6F	.2500	.386	11/16	.776	8-32(2)
SAV-30-3M-06 X 1/4	30	1.128	1.098	1.250	6F	.2500	.386	11/16	.776	8-32(2)
32-3M-06 X 1/4	32	1.203	1.173	1.323	6F	.2500	.386	11/16	.851	8-32(2)
SAV-32-3M-06 X 1/4	32	1.203	1.173	1.323	6F	.2500	.386	11/16	.851	8-32(2)

“SAV.” in front of any standard timing pulley part # represents the Shaft-Saver version. Shaft-Saver pulleys have special setscrews that grip without damage to the shaft and allow easy pulley removal and realignment. For additional information, see our Shaft-Saver Engineering Section.

York also manufactures custom pulleys and complete assemblies
 email:support@york-ind.com web: www.york-ind.com



ALUMINUM WITH CLEAR ANODIZE (RoHS compliant)

FOR BELTS UP TO 6MM WIDE

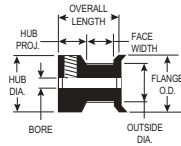

TYPE 6FC

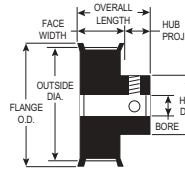

TYPE 6F

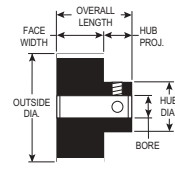

TYPE 6

PART NUMBER	NO. OF GROOVES	PITCH DIA.	OUTSIDE DIA.	FLANGE O.D.	TYPE	BORE (+.001 / -.000)	FACE WIDTH	OVERALL LENGTH	HUB DIA.	SET SCREWS
34-3M-06 X 1/4	34	1.278	1.248	1.398	6F	.2500	.407	23/32	.921	8-32(2)
SAV-34-3M-06 X 1/4	34	1.278	1.248	1.398	6F	.2500	.407	23/32	.921	8-32(2)
36-3M-06 X 1/4	36	1.353	1.324	1.473	6F	.2500	.407	23/32	1.000	8-32(2)
SAV-36-3M-06 X 1/4	36	1.353	1.324	1.473	6F	.2500	.407	23/32	1.000	8-32(2)
38-3M-06 X 1/4	38	1.429	1.399	1.549	6F	.2500	.407	23/32	1.075	8-32(2)
SAV-38-3M-06 X 1/4	38	1.429	1.399	1.549	6F	.2500	.407	23/32	1.075	8-32(2)
40-3M-06 X 1/4	40	1.504	1.474	1.625	6F	.2500	.407	23/32	1.150	8-32(2)
SAV-40-3M-06 X 1/4	40	1.504	1.474	1.625	6F	.2500	.407	23/32	1.150	8-32(2)
44-3M-06 X 1/4	44	1.654	1.624	1.775	6F	.2500	.407	23/32	1.300	8-32(2)
SAV-44-3M-06 X 1/4	44	1.654	1.624	1.775	6F	.2500	.407	23/32	1.300	8-32(2)
50-3M-06 X 5/16	50	1.880	1.850	—	6	.3125	.407	47/64	1.250	8-32(2)
SAV-50-3M-06 X 5/16	50	1.880	1.850	—	6	.3125	.407	47/64	1.250	8-32(2)
56-3M-06 X 5/16	56	2.105	2.075	—	6	.3125	.407	47/64	1.250	8-32(2)
SAV-56-3M-06 X 5/16	56	2.105	2.075	—	6	.3125	.407	47/64	1.250	8-32(2)
62-3M-06 X 5/16	62	2.331	2.301	—	6	.3125	.407	47/64	1.250	8-32(2)
SAV-62-3M-06 X 5/16	62	2.331	2.301	—	6	.3125	.407	47/64	1.250	8-32(2)
72-3M-06 X 5/16	72	2.707	2.677	—	6	.3125	.407	47/64	1.250	8-32(2)
SAV-72-3M-06 X 5/16	72	2.707	2.677	—	6	.3125	.407	47/64	1.250	8-32(2)

“SAV-” in front of any standard timing pulley part # represents the Shaft-Saver version. Shaft-Saver pulleys have special setscrews that grip without damage to the shaft and allow easy pulley removal and realignment. For additional information, see our Shaft-Saver Engineering Section.

ALUMINUM WITH CLEAR ANODIZE (RoHS compliant)

FOR BELTS UP TO 9MM WIDE

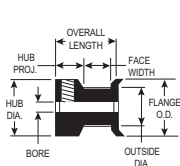

TYPE 6FC

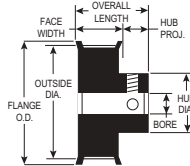

TYPE 6F

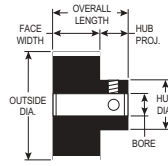

TYPE 6



PART NUMBER	NO. OF GROOVES	PITCH DIA.	OUTSIDE DIA.	FLANGE O.D.	TYPE	BORE (+.001 / -.000)	FACE WIDTH	OVERALL LENGTH	HUB DIA.	SET SCREWS
10-3M-09 X 1/8	10	.376	.346	.505	6FC	.1250	.401	11/16	.505	4-40(1)
SAV-10-3M-09 X 1/8	10	.376	.346	.505	6FC	.1250	.401	11/16	.505	4-40(1)
12-3M-09 X 3/16	12	.451	.421	.580	6FC	.1875	.401	11/16	.580	6-40(1)
SAV-12-3M-09 X 3/16	12	.451	.421	.580	6FC	.1875	.401	11/16	.580	6-40(1)
14-3M-09 X 3/16	14	.526	.496	.635	6FC	.1875	.401	11/16	.635	6-40(2)
SAV-14-3M-09 X 3/16	14	.526	.496	.635	6FC	.1875	.401	11/16	.635	6-40(2)
15-3M-09 X 3/16	15	.564	.534	.685	6FC	.1875	.401	11/16	.685	6-40(2)
SAV-15-3M-09 X 3/16	15	.564	.534	.685	6FC	.1875	.401	11/16	.685	6-40(2)
16-3M-09 X 3/16	16	.602	.572	.710	6FC	.1875	.401	11/16	.710	6-40(2)
SAV-16-3M-09 X 3/16	16	.602	.572	.710	6FC	.1875	.401	11/16	.710	6-40(2)
17-3M-09 X 3/16	17	.639	.609	.740	6FC	.1875	.401	11/16	.740	6-40(2)
SAV-17-3M-09 X 3/16	17	.639	.609	.740	6FC	.1875	.401	11/16	.740	6-40(2)
18-3M-09 X 1/4	18	.677	.647	.790	6F	.2500	.506	13/16	.442	8-32(2)
SAV-18-3M-09 X 1/4	18	.677	.647	.790	6F	.2500	.506	13/16	.442	8-32(2)
19-3M-09 X 1/4	19	.714	.684	.827	6F	.2500	.506	13/16	.468	8-32(2)
SAV-19-3M-09 X 1/4	19	.714	.684	.827	6F	.2500	.506	13/16	.468	8-32(2)
20-3M-09 X 1/4	20	.752	.722	.895	6F	.2500	.506	13/16	.500	8-32(2)
SAV-20-3M-09 X 1/4	20	.752	.722	.895	6F	.2500	.506	13/16	.500	8-32(2)
22-3M-09 X 1/4	22	.827	.797	.945	6F	.2500	.506	13/16	.562	8-32(2)
SAV-22-3M-09 X 1/4	22	.827	.797	.945	6F	.2500	.506	13/16	.562	8-32(2)
24-3M-09 X 1/4	24	.902	.872	1.025	6F	.2500	.506	13/16	.625	8-32(2)
SAV-24-3M-09 X 1/4	24	.902	.872	1.025	6F	.2500	.506	13/16	.625	8-32(2)
26-3M-09 X 1/4	26	.977	.947	1.105	6F	.2500	.506	13/16	.625	8-32(2)
SAV-26-3M-09 X 1/4	26	.977	.947	1.105	6F	.2500	.506	13/16	.625	8-32(2)
28-3M-09 X 1/4	28	1.053	1.023	1.173	6F	.2500	.506	13/16	.701	8-32(2)
SAV-28-3M-09 X 1/4	28	1.053	1.023	1.173	6F	.2500	.506	13/16	.701	8-32(2)
30-3M-09 X 1/4	30	1.128	1.098	1.250	6F	.2500	.506	13/16	.776	8-32(2)
SAV-30-3M-09 X 1/4	30	1.128	1.098	1.250	6F	.2500	.506	13/16	.776	8-32(2)
32-3M-09 X 1/4	32	1.203	1.173	1.323	6F	.2500	.506	13/16	.851	8-32(2)
SAV-32-3M-09 X 1/4	32	1.203	1.173	1.323	6F	.2500	.506	13/16	.851	8-32(2)

“SAV.” in front of any standard timing pulley part # represents the Shaft-Saver version. Shaft-Saver pulleys have special setscrews that grip without damage to the shaft and allow easy pulley removal and realignment. For additional information, see our Shaft-Saver Engineering Section.

York also manufactures custom pulleys and complete assemblies
 email:support@york-ind.com web: www.york-ind.com



ALUMINUM WITH CLEAR ANODIZE (RoHS compliant)

FOR BELTS UP TO 9MM WIDE

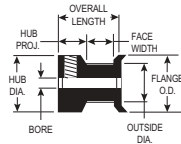

TYPE 6FC

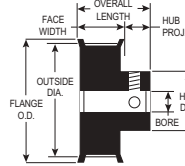

TYPE 6F

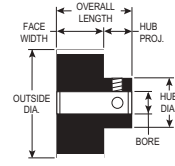

TYPE 6

PART NUMBER	NO. OF GROOVES	PITCH DIA.	OUTSIDE DIA.	FLANGE O.D.	TYPE	BORE (+.001 / -.000)	FACE WIDTH	OVERALL LENGTH	HUB DIA.	SET SCREWS
34-3M-09 X 1/4	34	1.278	1.248	1.398	6F	.2500	.527	27/32	.921	8-32(2)
SAV-34-3M-09 X 1/4	34	1.278	1.248	1.398	6F	.2500	.527	27/32	.921	8-32(2)
36-3M-09 X 1/4	36	1.353	1.324	1.473	6F	.2500	.527	27/32	1.000	8-32(2)
SAV-36-3M-09 X 1/4	36	1.353	1.324	1.473	6F	.2500	.527	27/32	1.000	8-32(2)
38-3M-09 X 1/4	38	1.429	1.399	1.549	6F	.2500	.527	27/32	1.075	8-32(2)
SAV-38-3M-09 X 1/4	38	1.429	1.399	1.549	6F	.2500	.527	27/32	1.075	8-32(2)
40-3M-09 X 1/4	40	1.504	1.474	1.625	6F	.2500	.527	27/32	1.150	8-32(2)
SAV-40-3M-09 X 1/4	40	1.504	1.474	1.625	6F	.2500	.527	27/32	1.150	8-32(2)
44-3M-09 X 1/4	44	1.654	1.624	1.775	6F	.2500	.527	27/32	1.300	8-32(2)
SAV-44-3M-09 X 1/4	44	1.654	1.624	1.775	6F	.2500	.527	27/32	1.300	8-32(2)
50-3M-09 X 5/16	50	1.880	1.850	—	6	.3125	.500	7/8	1.250	8-32(2)
SAV-50-3M-09 X 5/16	50	1.880	1.850	—	6	.3125	.500	7/8	1.250	8-32(2)
56-3M-09 X 5/16	56	2.105	2.075	—	6	.3125	.500	7/8	1.250	8-32(2)
SAV-56-3M-09 X 5/16	56	2.105	2.075	—	6	.3125	.500	7/8	1.250	8-32(2)
62-3M-09 X 5/16	62	2.331	2.301	—	6	.3125	.500	7/8	1.250	8-32(2)
SAV-62-3M-09 X 5/16	62	2.331	2.301	—	6	.3125	.500	7/8	1.250	8-32(2)
72-3M-09 X 5/16	72	2.707	2.677	—	6	.3125	.500	7/8	1.250	8-32(2)
SAV-72-3M-09 X 5/16	72	2.707	2.677	—	6	.3125	.500	7/8	1.250	8-32(2)

“SAV-” in front of any standard timing pulley part # represents the Shaft-Saver version. Shaft-Saver pulleys have special setscrews that grip without damage to the shaft and allow easy pulley removal and realignment. For additional information, see our Shaft-Saver Engineering Section.

ALUMINUM WITH CLEAR ANODIZE (RoHS compliant)

FOR BELTS UP TO 15MM WIDE

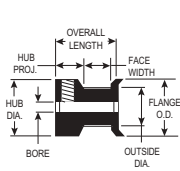

TYPE 6FC

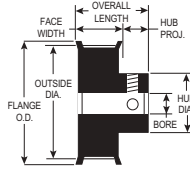

TYPE 6F

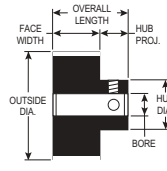

TYPE 6



PART NUMBER	NO. OF GROOVES	PITCH DIA.	OUTSIDE DIA.	FLANGE O.D.	TYPE	BORE		FACE WIDTH	OVERALL LENGTH	HUB DIA.	SET SCREWS
						(+.001)	(-.000)				
10-3M-15 X 1/8	10	.376	.346	.505	6FC	.1250	.637	.927	.505	4-40(1)	
SAV-10-3M-15 X 1/8	10	.376	.346	.505	6FC	.1250	.637	.927	.505	4-40(1)	
12-3M-15 X 3/16	12	.451	.421	.580	6FC	.1875	.637	.927	.580	6-40(1)	
SAV-12-3M-15 X 3/16	12	.451	.421	.580	6FC	.1875	.637	.927	.580	6-40(1)	
14-3M-15 X 3/16	14	.526	.496	.635	6FC	.1875	.637	.927	.635	6-40(2)	
SAV-14-3M-15 X 3/16	14	.526	.496	.635	6FC	.1875	.637	.927	.635	6-40(2)	
15-3M-15 X 3/16	15	.564	.534	.685	6FC	.1875	.637	.927	.685	6-40(2)	
SAV-15-3M-15 X 3/16	15	.564	.534	.685	6FC	.1875	.637	.927	.685	6-40(2)	
16-3M-15 X 3/16	16	.602	.572	.710	6FC	.1875	.637	.927	.710	6-40(2)	
SAV-16-3M-15 X 3/16	16	.602	.572	.710	6FC	.1875	.637	.927	.710	6-40(2)	
17-3M-15 X 3/16	17	.639	.609	.740	6FC	.1875	.637	.927	.740	6-40(2)	
SAV-17-3M-15 X 3/16	17	.639	.609	.740	6FC	.1875	.637	.927	.740	6-40(2)	
18-3M-15 X 1/4	18	.677	.647	.790	6F	.2500	.742	1.057	.442	8-32(2)	
SAV-18-3M-15 X 1/4	18	.677	.647	.790	6F	.2500	.742	1.057	.442	8-32(2)	
19-3M-15 X 1/4	19	.714	.684	.827	6F	.2500	.742	1.057	.468	8-32(2)	
SAV-19-3M-15 X 1/4	19	.714	.684	.827	6F	.2500	.742	1.057	.468	8-32(2)	
20-3M-15 X 1/4	20	.752	.722	.895	6F	.2500	.742	1.057	.500	8-32(2)	
SAV-20-3M-15 X 1/4	20	.752	.722	.895	6F	.2500	.742	1.057	.500	8-32(2)	
22-3M-15 X 1/4	22	.827	.797	.945	6F	.2500	.742	1.057	.562	8-32(2)	
SAV-22-3M-15 X 1/4	22	.827	.797	.945	6F	.2500	.742	1.057	.562	8-32(2)	
24-3M-15 X 1/4	24	.902	.872	1.025	6F	.2500	.742	1.057	.625	8-32(2)	
SAV-24-3M-15 X 1/4	24	.902	.872	1.025	6F	.2500	.742	1.057	.625	8-32(2)	
26-3M-15 X 1/4	26	.977	.947	1.105	6F	.2500	.742	1.057	.625	8-32(2)	
SAV-26-3M-15 X 1/4	26	.977	.947	1.105	6F	.2500	.742	1.057	.625	8-32(2)	
28-3M-15 X 1/4	28	1.053	1.023	1.173	6F	.2500	.742	1.057	.701	8-32(2)	
SAV-28-3M-15 X 1/4	28	1.053	1.023	1.173	6F	.2500	.742	1.057	.701	8-32(2)	
30-3M-15 X 1/4	30	1.128	1.098	1.250	6F	.2500	.742	1.057	.776	8-32(2)	
SAV-30-3M-15 X 1/4	30	1.128	1.098	1.250	6F	.2500	.742	1.057	.776	8-32(2)	
32-3M-15 X 1/4	32	1.203	1.173	1.323	6F	.2500	.742	1.057	.851	8-32(2)	
SAV-32-3M-15 X 1/4	32	1.203	1.173	1.323	6F	.2500	.742	1.057	.851	8-32(2)	

“SAV.” in front of any standard timing pulley part # represents the Shaft-Saver version. Shaft-Saver pulleys have special setscrews that grip without damage to the shaft and allow easy pulley removal and realignment. For additional information, see our Shaft-Saver Engineering Section.

York also manufactures custom pulleys and complete assemblies
 email:support@york-ind.com web: www.york-ind.com



ALUMINUM WITH CLEAR ANODIZE (RoHS compliant)

FOR BELTS UP TO 15MM WIDE

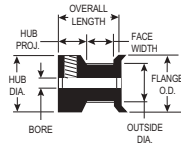

TYPE 6FC

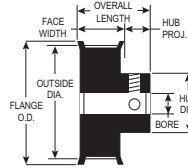

TYPE 6F

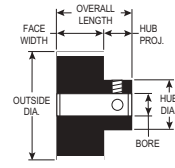

TYPE 6

PART NUMBER	NO. OF GROOVES	PITCH DIA.	OUTSIDE DIA.	FLANGE O.D.	TYPE	BORE		OVERALL LENGTH	HUB DIA.	SET SCREWS
						(+.001)	(-.000)			
34-3M-15 X 1/4	34	1.278	1.248	1.398	6F	.2500	.763	1.069	.921	8-32(2)
SAV-34-3M-15 X 1/4	34	1.278	1.248	1.398	6F	.2500	.763	1.069	.921	8-32(2)
36-3M-15 X 1/4	36	1.353	1.324	1.473	6F	.2500	.763	1.069	1.000	8-32(2)
SAV-36-3M-15 X 1/4	36	1.353	1.324	1.473	6F	.2500	.763	1.069	1.000	8-32(2)
38-3M-15 X 1/4	38	1.429	1.399	1.549	6F	.2500	.763	1.069	1.075	8-32(2)
SAV-38-3M-15 X 1/4	38	1.429	1.399	1.549	6F	.2500	.763	1.069	1.075	8-32(2)
40-3M-15 X 1/4	40	1.504	1.474	1.625	6F	.2500	.763	1.069	1.150	8-32(2)
SAV-40-3M-15 X 1/4	40	1.504	1.474	1.625	6F	.2500	.763	1.069	1.150	8-32(2)
44-3M-15 X 1/4	44	1.654	1.624	1.775	6F	.2500	.763	1.069	1.300	8-32(2)
SAV-44-3M-15 X 1/4	44	1.654	1.624	1.775	6F	.2500	.763	1.069	1.300	8-32(2)
50-3M-15 X 5/16	50	1.880	1.850	—	6	.3125	.736	1.111	1.250	8-32(2)
SAV-50-3M-15 X 5/16	50	1.880	1.850	—	6	.3125	.736	1.111	1.250	8-32(2)
56-3M-15 X 5/16	56	2.105	2.075	—	6	.3125	.736	1.111	1.250	8-32(2)
SAV-56-3M-15 X 5/16	56	2.105	2.075	—	6	.3125	.736	1.111	1.250	8-32(2)
62-3M-15 X 5/16	62	2.331	2.301	—	6	.3125	.736	1.111	1.250	8-32(2)
SAV-62-3M-15 X 5/16	62	2.331	2.301	—	6	.3125	.736	1.111	1.250	8-32(2)
72-3M-15 X 5/16	72	2.707	2.677	—	6	.3125	.736	1.111	1.250	8-32(2)
SAV-72-3M-15 X 5/16	72	2.707	2.677	—	6	.3125	.736	1.111	1.250	8-32(2)

“SAV-” in front of any standard timing pulley part # represents the Shaft-Saver version. Shaft-Saver pulleys have special setscrews that grip without damage to the shaft and allow easy pulley removal and realignment. For additional information, see our Shaft-Saver Engineering Section.

ALUMINUM 6061-T6 (RoHS compliant)

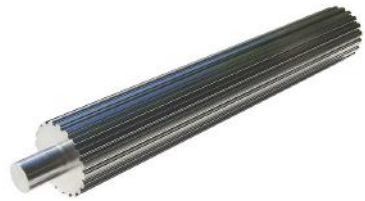
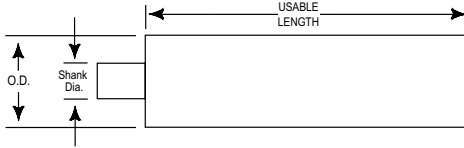

PART NUMBER	NO. OF GROOVES	PITCH DIA.	OUTSIDE DIA.	SHANK DIA.	USEABLE LENGTH
9-3M-P-3A	9	.338	.308	3/8	3"
10-3M-P-3A	10	.376	.346	3/8	3"
11-3M-P-3A	11	.414	.384	3/8	3"
12-3M-P-4A	12	.451	.421	3/8	4"
13-3M-P-4A	13	.489	.459	7/16	4"
14-3M-P-4A	14	.526	.496	7/16	4"
15-3M-P-4A	15	.564	.534	1/2	4"
16-3M-P-5A	16	.602	.572	1/2	5"
17-3M-P-5A	17	.639	.609	1/2	5"
18-3M-P-5A	18	.677	.647	1/2	5"
19-3M-P-5A	19	.714	.684	1/2	5"
20-3M-P-6A	20	.752	.722	1/2	6"
21-3M-P-6A	21	.790	.760	1/2	6"
22-3M-P-6A	22	.827	.797	1/2	6"
23-3M-P-6A	23	.865	.835	1/2	6"
24-3M-P-6A	24	.902	.872	1/2	6"
25-3M-P-6A	25	.940	.910	1/2	6"
26-3M-P-6A	26	.977	.947	1/2	6"
27-3M-P-6A	27	1.015	.985	1/2	6"
28-3M-P-6A	28	1.053	1.023	1/2	6"
29-3M-P-6A	29	1.090	1.060	1/2	6"
30-3M-P-7A	30	1.128	1.098	1/2	7"
31-3M-P-7A	31	1.165	1.135	1/2	7"
32-3M-P-7A	32	1.203	1.173	1/2	7"
33-3M-P-7A	33	1.241	1.211	1/2	7"
34-3M-P-7A	34	1.278	1.248	1/2	7"
35-3M-P-7A	35	1.316	1.286	1/2	7"

York also manufactures custom pulleys and complete assemblies
 email: support@york-ind.com web: www.york-ind.com



ALUMINUM 6061-T6 (RoHS compliant)

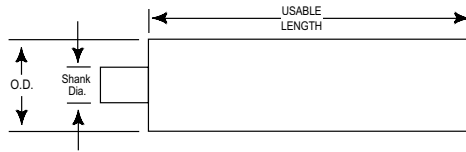
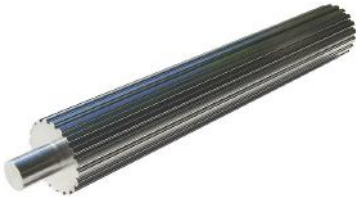

PART NUMBER	NO. OF GROOVES	PITCH DIA.	OUTSIDE DIA.	SHANK DIA.	USEABLE LENGTH
36-3M-P-8A	36	1.353	1.323	1/2	8"
37-3M-P-8A	37	1.391	1.361	1/2	8"
38-3M-P-8A	38	1.429	1.399	1/2	8"
39-3M-P-8A	39	1.466	1.436	1/2	8"
40-3M-P-8A	40	1.504	1.474	1/2	8"
42-3M-P-8A	42	1.579	1.549	1/2	8"
44-3M-P-8A	44	1.654	1.624	1/2	8"
45-3M-P-8A	45	1.692	1.662	1/2	8"
48-3M-P-8A	48	1.805	1.775	1/2	8"
50-3M-P-8A	50	1.880	1.850	3/4	8"
52-3M-P-8A	52	1.955	1.925	3/4	8"
54-3M-P-8A	54	2.030	2.000	3/4	8"
56-3M-P-8A	56	2.105	2.075	3/4	8"
60-3M-P-8A	60	2.256	2.226	3/4	8"
62-3M-P-8A	62	2.331	2.301	3/4	8"
64-3M-P-8A	64	2.406	2.376	3/4	8"
66-3M-P-8A	66	2.481	2.451	3/4	8"
68-3M-P-8A	68	2.557	2.527	3/4	8"
70-3M-P-8A	70	2.632	2.602	3/4	8"
72-3M-P-8A	72	2.707	2.677	3/4	8"
75-3M-P-8A	75	2.820	2.790	3/4	8"
80-3M-P-8A	80	3.008	2.978	3/4	8"
90-3M-P-8A	90	3.384	3.354	3/4	8"
100-3M-P-8A	100	3.760	3.730	1	8"
110-3M-P-8A	110	4.136	4.106	1	8"
120-3M-P-8A	120	4.511	4.481	1	8"
130-3M-P-8A	130	4.887	4.857	1	8"
140-3M-P-8A	140	5.263	5.233	1	8"
150-3M-P-8A	150	5.639	5.609	1	8"
160-3M-P-8A	160	6.015	5.985	1	8"

STEEL (RoHS compliant)

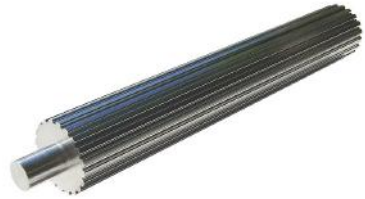
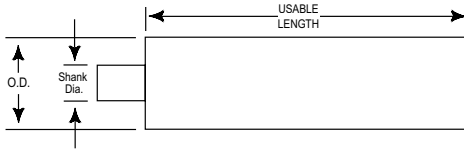

PART NUMBER	NO. OF GROOVES	PITCH DIA.	OUTSIDE DIA.	SHANK DIA.	USEABLE LENGTH
9-3M-P-3S	9	.338	.308	3/8	3"
10-3M-P-3S	10	.376	.346	3/8	3"
11-3M-P-3S	11	.414	.384	3/8	3"
12-3M-P-4S	12	.451	.421	3/8	4"
13-3M-P-4S	13	.489	.459	7/16	4"
14-3M-P-4S	14	.526	.496	7/16	4"
15-3M-P-4S	15	.564	.534	1/2	4"
16-3M-P-5S	16	.602	.572	1/2	5"
17-3M-P-5S	17	.639	.609	1/2	5"
18-3M-P-5S	18	.677	.647	1/2	5"
19-3M-P-5S	19	.714	.684	1/2	5"
20-3M-P-6S	20	.752	.722	1/2	6"
21-3M-P-6S	21	.790	.760	1/2	6"
22-3M-P-6S	22	.827	.797	1/2	6"
23-3M-P-6S	23	.865	.835	1/2	6"
24-3M-P-6S	24	.902	.872	1/2	6"
25-3M-P-6S	25	.940	.910	1/2	6"
26-3M-P-6S	26	.977	.947	1/2	6"
27-3M-P-6S	27	1.015	.985	1/2	6"
28-3M-P-6S	28	1.053	1.023	1/2	6"
29-3M-P-6S	29	1.090	1.060	1/2	6"
30-3M-P-7S	30	1.128	1.098	1/2	7"
31-3M-P-7S	31	1.165	1.135	1/2	7"
32-3M-P-7S	32	1.203	1.173	1/2	7"
33-3M-P-7S	33	1.241	1.211	1/2	7"
34-3M-P-7S	34	1.278	1.248	1/2	7"
35-3M-P-7S	35	1.316	1.286	1/2	7"

York also manufactures custom pulleys and complete assemblies
 email: support@york-ind.com web: www.york-ind.com



STEEL (RoHS compliant)

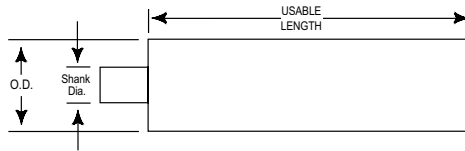
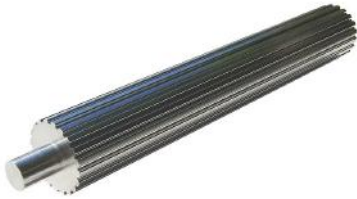

PART NUMBER	NO. OF GROOVES	PITCH DIA.	OUTSIDE DIA.	SHANK DIA.	USEABLE LENGTH
36-3M-P-8S	36	1.353	1.323	1/2	8"
37-3M-P-8S	37	1.391	1.361	1/2	8"
38-3M-P-8S	38	1.429	1.399	1/2	8"
39-3M-P-8S	39	1.466	1.436	1/2	8"
40-3M-P-8S	40	1.504	1.474	1/2	8"
42-3M-P-8S	42	1.579	1.549	1/2	8"
44-3M-P-8S	44	1.654	1.624	1/2	8"
45-3M-P-8S	45	1.692	1.662	1/2	8"
48-3M-P-8S	48	1.805	1.775	1/2	8"
50-3M-P-8S	50	1.880	1.850	3/4	8"
52-3M-P-8S	52	1.955	1.925	3/4	8"
54-3M-P-8S	54	2.030	2.000	3/4	8"
56-3M-P-8S	56	2.105	2.075	3/4	8"
60-3M-P-8S	60	2.256	2.226	3/4	8"
62-3M-P-8S	62	2.331	2.301	3/4	8"
64-3M-P-8S	64	2.406	2.376	3/4	8"
66-3M-P-8S	66	2.481	2.451	3/4	8"
68-3M-P-8S	68	2.557	2.527	3/4	8"
70-3M-P-8S	70	2.632	2.602	3/4	8"
72-3M-P-8S	72	2.707	2.677	3/4	8"
75-3M-P-8S	75	2.820	2.790	3/4	8"
80-3M-P-8S	80	3.008	2.978	3/4	8"
90-3M-P-8S	90	3.384	3.354	3/4	8"
100-3M-P-8S	100	3.760	3.730	1	8"
110-3M-P-8S	110	4.136	4.106	1	8"
120-3M-P-8S	120	4.511	4.481	1	8"
130-3M-P-8S	130	4.887	4.857	1	8"
140-3M-P-8S	140	5.263	5.233	1	8"
150-3M-P-8S	150	5.639	5.609	1	8"

ALUMINUM (RoHS compliant)

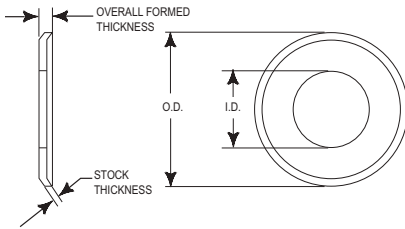

PART NUMBER	INSIDE DIA.	OUTSIDE DIA.	STOCK THICKNESS	OVERALL FORMED THICKNESS
10-3M-F5A	.244	.505	.025	.045
11-3M-F5A	.270	.530	.025	.045
12-3M-F5A	.322	.580	.025	.045
13-3M-F5A	.350	.610	.025	.045
14-3M-F5A	.374	.635	.032	.052
15-3M-F5A	.426	.685	.032	.052
16-3M-F5A	.452	.710	.032	.052
17-3M-F5A	.452	.740	.032	.052
18-3M-F5A	.504	.790	.032	.052
19-3M-F5A	.541	.827	.032	.052
20-3M-F5A	.574	.895	.032	.052
22-3M-F5A	.626	.945	.032	.052
24-3M-F5A	.704	1.025	.032	.052
25-3M-F5A	.738	1.060	.032	.052
26-3M-F5A	.774	1.105	.032	.052
28-3M-F5A	.849	1.173	.032	.052
30-3M-F5A	.924	1.250	.032	.052
32-3M-F5A	.999	1.323	.032	.052
34-3M-F5A	1.074	1.398	.040	.060
36-3M-F5A	1.149	1.478	.040	.060
38-3M-F5A	1.225	1.549	.040	.060
40-3M-F5A	1.300	1.625	.040	.060
44-3M-F5A	1.450	1.775	.040	.060

York also manufactures custom pulleys and complete assemblies
 email: support@york-ind.com web: www.york-ind.com



STEEL (RoHS compliant)

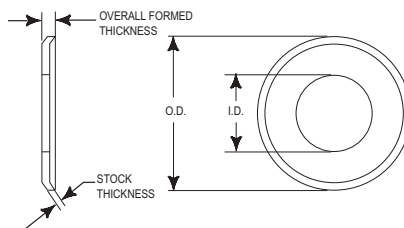

PART NUMBER	INSIDE DIA.	OUTSIDE DIA.	STOCK THICKNESS	OVERALL FORMED THICKNESS
10-3M-F6S	.244	.505	.025	.045
11-3M-F6S	.270	.530	.025	.045
12-3M-F6S	.322	.580	.025	.045
13-3M-F6S	.350	.610	.025	.045
14-3M-F6S	.374	.635	.032	.052
15-3M-F6S	.426	.685	.032	.052
16-3M-F6S	.452	.710	.032	.052
17-3M-F6S	.452	.740	.032	.052
18-3M-F6S	.504	.790	.032	.052
19-3M-F6S	.541	.827	.032	.052
20-3M-F6S	.574	.895	.032	.052
22-3M-F6S	.626	.945	.032	.052
24-3M-F6S	.704	1.025	.032	.052
25-3M-F6S	.738	1.060	.032	.052
26-3M-F6S	.774	1.105	.032	.052
28-3M-F6S	.849	1.173	.032	.052
30-3M-F6S	.924	1.250	.032	.052
32-3M-F6S	.999	1.323	.032	.052
34-3M-F6S	1.074	1.398	.040	.060
36-3M-F6S	1.149	1.478	.040	.060
38-3M-F6S	1.225	1.549	.040	.060
40-3M-F6S	1.300	1.625	.040	.060
44-3M-F6S	1.450	1.775	.040	.060

BLACK NEOPRENE, Fiberglass Cord (RoHS compliant)

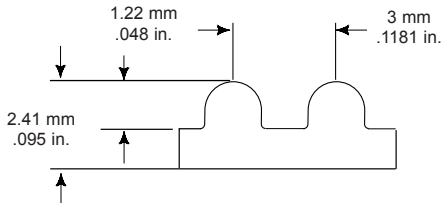

BELT NUMBER	WIDTHS			PITCH LENGTH (MM)	NO. OF TEETH	BELT NUMBER	WIDTHS			PITCH LENGTH (MM)	NO. OF TEETH
	6MM	9MM	15MM				6MM	9MM	15MM		
87-3M	06	09	15	87	29	219-3M	06	09	15	219	73
102-3M	06	09	15	102	34	222-3M	06	09	15	222	74
105-3M	06	09	15	105	35	225-3M	06	09	15	225	75
111-3M	06	09	15	111	37	228-3M	06	09	15	228	76
123-3M	06	09	15	123	41	234-3M	06	09	15	234	78
126-3M	06	09	15	126	42	237-3M	06	09	15	237	79
129-3M	06	09	15	129	43	240-3M	06	09	15	240	80
141-3M	06	09	15	141	47	246-3M	06	09	15	246	82
144-3M	06	09	15	144	48	249-3M	06	09	15	249	83
147-3M	06	09	15	147	49	252-3M	06	09	15	252	84
150-3M	06	09	15	150	50	255-3M	06	09	15	255	85
156-3M	06	09	15	156	52	258-3M	06	09	15	258	86
159-3M	06	09	15	159	53	261-3M	06	09	15	261	87
165-3M	06	09	15	165	55	264-3M	06	09	15	264	88
168-3M	06	09	15	168	56	267-3M	06	09	15	267	89
174-3M	06	09	15	174	58	270-3M	06	09	15	270	90
177-3M	06	09	15	177	59	276-3M	06	09	15	276	92
180-3M	06	09	15	180	60	282-3M	06	09	15	282	94
183-3M	06	09	15	183	61	285-3M	06	09	15	285	95
186-3M	06	09	15	186	62	288-3M	06	09	15	288	96
189-3M	06	09	15	189	63	291-3M	06	09	15	291	97
192-3M	06	09	15	192	64	294-3M	06	09	15	294	98
195-3M	06	09	15	195	65	297-3M	06	09	15	297	99
201-3M	06	09	15	201	67	300-3M	06	09	15	300	100
204-3M	06	09	15	204	68	306-3M	06	09	15	306	102
207-3M	06	09	15	207	69	312-3M	06	09	15	312	104
210-3M	06	09	15	210	70	315-3M	06	09	15	315	105
213-3M	06	09	15	213	71	318-3M	06	09	15	318	106
216-3M	06	09	15	216	72	324-3M	06	09	15	324	108

Need a clean, low dust belt? See TruMotion belts.

York also manufactures custom pulleys and complete assemblies
 email: support@york-ind.com web: www.york-ind.com



BLACK NEOPRENE, Fiberglass Cord (RoHS compliant)

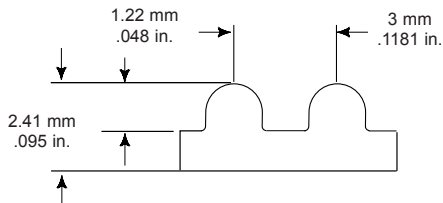

BELT NUMBER	6MM	WIDTHS 9MM	15MM	PITCH LENGTH (MM)	NO. OF TEETH	BELT NUMBER	6MM	WIDTHS 9MM	15MM	PITCH LENGTH (MM)	NO. OF TEETH
330-3M	06	09	15	330	110	468-3M	06	09	15	468	156
333-3M	06	09	15	333	111	471-3M	06	09	15	471	157
336-3M	06	09	15	336	112	474-3M	06	09	15	474	158
339-3M	06	09	15	339	113	477-3M	06	09	15	477	159
345-3M	06	09	15	345	115	480-3M	06	09	15	480	160
357-3M	06	09	15	357	119	486-3M	06	09	15	486	162
360-3M	06	09	15	360	120	489-3M	06	09	15	489	163
363-3M	06	09	15	363	121	492-3M	06	09	15	492	164
366-3M	06	09	15	366	122	501-3M	06	09	15	501	167
369-3M	06	09	15	369	123	510-3M	06	09	15	510	170
372-3M	06	09	15	372	124	513-3M	06	09	15	513	171
381-3M	06	09	15	381	127	519-3M	06	09	15	519	173
384-3M	06	09	15	384	128	522-3M	06	09	15	522	174
390-3M	06	09	15	390	130	525-3M	06	09	15	525	175
396-3M	06	09	15	396	132	528-3M	06	09	15	528	176
399-3M	06	09	15	399	133	531-3M	06	09	15	531	177
405-3M	06	09	15	405	135	537-3M	06	09	15	537	179
411-3M	06	09	15	411	137	552-3M	06	09	15	552	184
417-3M	06	09	15	417	139	558-3M	06	09	15	558	186
420-3M	06	09	15	420	140	564-3M	06	09	15	564	188
426-3M	06	09	15	426	142	570-3M	06	09	15	570	190
432-3M	06	09	15	432	144	573-3M	06	09	15	573	191
435-3M	06	09	15	435	145	576-3M	06	09	15	576	192
438-3M	06	09	15	438	146	582-3M	06	09	15	582	194
444-3M	06	09	15	444	148	585-3M	06	09	15	585	195
447-3M	06	09	15	447	149	591-3M	06	09	15	591	197
462-3M	06	09	15	462	154	594-3M	06	09	15	594	198
465-3M	06	09	15	465	155	597-3M	06	09	15	597	199

If you don't see the belt you need – call York!

BLACK NEOPRENE, Fiberglass Cord (RoHS compliant)

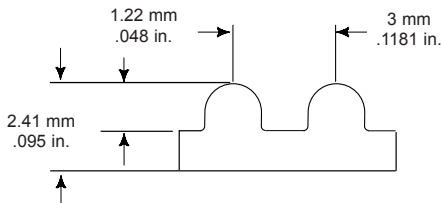

BELT NUMBER	WIDTHS			PITCH LENGTH (MM)	NO. OF TEETH	BELT NUMBER	WIDTHS			PITCH LENGTH (MM)	NO. OF TEETH
	6MM	9MM	15MM				6MM	9MM	15MM		
600-3M	06	09	15	600	200	873-3M	06	09	15	873	291
606-3M	06	09	15	606	202	882-3M	06	09	15	882	294
609-3M	06	09	15	609	203	891-3M	06	09	15	891	297
612-3M	06	09	15	612	204	900-3M	06	09	15	900	300
627-3M	06	09	15	627	209	915-3M	06	09	15	915	305
633-3M	06	09	15	633	211	945-3M	06	09	15	945	315
639-3M	06	09	15	639	213	951-3M	06	09	15	951	317
645-3M	06	09	15	645	215	981-3M	06	09	15	981	327
648-3M	06	09	15	648	216	1002-3M	06	09	15	1002	334
654-3M	06	09	15	654	218	1026-3M	06	09	15	1026	342
657-3M	06	09	15	657	219	1035-3M	06	09	15	1035	345
663-3M	06	09	15	663	221	1056-3M	06	09	15	1056	352
669-3M	06	09	15	669	223	1062-3M	06	09	15	1062	354
672-3M	06	09	15	672	224	1071-3M	06	09	15	1071	357
681-3M	06	09	15	681	227	1080-3M	06	09	15	1080	360
684-3M	06	09	15	684	228	1125-3M	06	09	15	1125	375
687-3M	06	09	15	687	229	1155-3M	06	09	15	1155	385
696-3M	06	09	15	696	232	1191-3M	06	09	15	1191	397
711-3M	06	09	15	711	237	1245-3M	06	09	15	1245	415
720-3M	06	09	15	720	240	1263-3M	06	09	15	1263	421
735-3M	06	09	15	735	245	1500-3M	06	09	15	1500	500
738-3M	06	09	15	738	246	1512-3M	06	09	15	1512	504
753-3M	06	09	15	753	251	1530-3M	06	09	15	1530	510
795-3M	06	09	15	795	265	1587-3M	06	09	15	1587	529
804-3M	06	09	15	804	268	1863-3M	06	09	15	1863	621
822-3M	06	09	15	822	274	1926-3M	06	09	15	1926	642
837-3M	06	09	15	837	279	1956-3M	06	09	15	1956	652
843-3M	06	09	15	843	281	2004-3M	06	09	15	2004	668

Need a clean, low dust belt? See TruMotion belts.

York also manufactures custom pulleys and complete assemblies
 email: support@york-ind.com web: www.york-ind.com



Cream Colored Engineered Polymer with Fiberglass Cord (RoHS compliant)

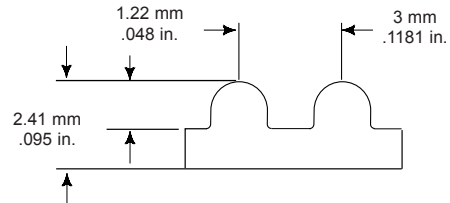
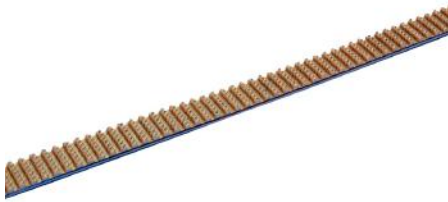

BELT NUMBER	WIDTHS			PITCH LENGTH (MM)	NO. OF TEETH	BELT NUMBER	WIDTHS			PITCH LENGTH (MM)	NO. OF TEETH
	6MM	9MM	15MM				6MM	9MM	15MM		
TM-87-3M	06	09	15	87	29	TM-219-3M	06	09	15	219	73
TM-102-3M	06	09	15	102	34	TM-222-3M	06	09	15	222	74
TM-105-3M	06	09	15	105	35	TM-225-3M	06	09	15	225	75
TM-111-3M	06	09	15	111	37	TM-228-3M	06	09	15	228	76
TM-123-3M	06	09	15	123	41	TM-234-3M	06	09	15	234	78
TM-126-3M	06	09	15	126	42	TM-237-3M	06	09	15	237	79
TM-129-3M	06	09	15	129	43	TM-240-3M	06	09	15	240	80
TM-141-3M	06	09	15	141	47	TM-246-3M	06	09	15	246	82
TM-144-3M	06	09	15	144	48	TM-249-3M	06	09	15	249	83
TM-147-3M	06	09	15	147	49	TM-252-3M	06	09	15	252	84
TM-150-3M	06	09	15	150	50	TM-255-3M	06	09	15	255	85
TM-156-3M	06	09	15	156	52	TM-258-3M	06	09	15	258	86
TM-159-3M	06	09	15	159	53	TM-261-3M	06	09	15	261	87
TM-165-3M	06	09	15	165	55	TM-264-3M	06	09	15	264	88
TM-168-3M	06	09	15	168	56	TM-267-3M	06	09	15	267	89
TM-174-3M	06	09	15	174	58	TM-270-3M	06	09	15	270	90
TM-177-3M	06	09	15	177	59	TM-276-3M	06	09	15	276	92
TM-180-3M	06	09	15	180	60	TM-282-3M	06	09	15	282	94
TM-183-3M	06	09	15	183	61	TM-285-3M	06	09	15	285	95
TM-186-3M	06	09	15	186	62	TM-288-3M	06	09	15	288	96
TM-189-3M	06	09	15	189	63	TM-291-3M	06	09	15	291	97
TM-192-3M	06	09	15	192	64	TM-294-3M	06	09	15	294	98
TM-195-3M	06	09	15	195	65	TM-297-3M	06	09	15	297	99
TM-201-3M	06	09	15	201	67	TM-300-3M	06	09	15	300	100
TM-204-3M	06	09	15	204	68	TM-306-3M	06	09	15	306	102
TM-207-3M	06	09	15	207	69	TM-312-3M	06	09	15	312	104
TM-210-3M	06	09	15	210	70	TM-315-3M	06	09	15	315	105
TM-213-3M	06	09	15	213	71	TM-318-3M	06	09	15	318	106
TM-216-3M	06	09	15	216	72	TM-324-3M	06	09	15	324	108

If you don't see the belt you need – call York!

YORK
ISO 9001: 2008 Registered

303 Nassau Blvd., Garden City Park, NY 11040

Tel: 1-800 354 8466 Fax: 1-800 354 8485

Cream Colored Engineered Polymer with Fiberglass Cord (RoHS compliant)

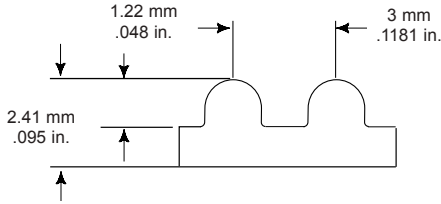

BELT NUMBER	WIDTHS			PITCH LENGTH (MM)	NO. OF TEETH	BELT NUMBER	WIDTHS			PITCH LENGTH (MM)	NO. OF TEETH
	6MM	9MM	15MM				6MM	9MM	15MM		
TM-330-3M	06	09	15	330	110	TM-468-3M	06	09	15	468	156
TM-333-3M	06	09	15	333	111	TM-471-3M	06	09	15	471	157
TM-336-3M	06	09	15	336	112	TM-474-3M	06	09	15	474	158
TM-339-3M	06	09	15	339	113	TM-477-3M	06	09	15	477	159
TM-345-3M	06	09	15	345	115	TM-480-3M	06	09	15	480	160
TM-357-3M	06	09	15	357	119	TM-486-3M	06	09	15	486	162
TM-360-3M	06	09	15	360	120	TM-489-3M	06	09	15	489	163
TM-363-3M	06	09	15	363	121	TM-492-3M	06	09	15	492	164
TM-366-3M	06	09	15	366	122	TM-501-3M	06	09	15	501	167
TM-369-3M	06	09	15	369	123	TM-510-3M	06	09	15	510	170
TM-372-3M	06	09	15	372	124	TM-513-3M	06	09	15	513	171
TM-381-3M	06	09	15	381	127	TM-519-3M	06	09	15	519	173
TM-384-3M	06	09	15	384	128	TM-522-3M	06	09	15	522	174
TM-390-3M	06	09	15	390	130	TM-525-3M	06	09	15	525	175
TM-396-3M	06	09	15	396	132	TM-528-3M	06	09	15	528	176
TM-399-3M	06	09	15	399	133	TM-531-3M	06	09	15	531	177
TM-405-3M	06	09	15	405	135	TM-537-3M	06	09	15	537	179
TM-411-3M	06	09	15	411	137	TM-552-3M	06	09	15	552	184
TM-417-3M	06	09	15	417	139	TM-558-3M	06	09	15	558	186
TM-420-3M	06	09	15	420	140	TM-564-3M	06	09	15	564	188
TM-426-3M	06	09	15	426	142	TM-570-3M	06	09	15	570	190
TM-432-3M	06	09	15	432	144	TM-573-3M	06	09	15	573	191
TM-435-3M	06	09	15	435	145	TM-576-3M	06	09	15	576	192
TM-438-3M	06	09	15	438	146	TM-582-3M	06	09	15	582	194
TM-444-3M	06	09	15	444	148	TM-585-3M	06	09	15	585	195
TM-447-3M	06	09	15	447	149	TM-591-3M	06	09	15	591	197
TM-462-3M	06	09	15	462	154	TM-594-3M	06	09	15	594	198
TM-465-3M	06	09	15	465	155	TM-597-3M	06	09	15	597	199

If you don't see the belt you need – call York!

York also manufactures custom pulleys and complete assemblies
 email: support@york-ind.com web: www.york-ind.com



Cream Colored Engineered Polymer with Fiberglass Cord (RoHS compliant)

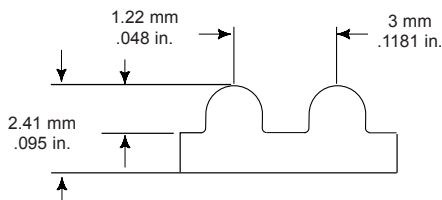

BELT NUMBER	WIDTHS			PITCH LENGTH (MM)	NO. OF TEETH	BELT NUMBER	WIDTHS			PITCH LENGTH (MM)	NO. OF TEETH
	6MM	9MM	15MM				6MM	9MM	15MM		
TM-600-3M	06	09	15	600	200	TM-873-3M	06	09	15	873	291
TM-606-3M	06	09	15	606	202	TM-882-3M	06	09	15	882	294
TM-609-3M	06	09	15	609	203	TM-891-3M	06	09	15	891	297
TM-612-3M	06	09	15	612	204	TM-900-3M	06	09	15	900	300
TM-627-3M	06	09	15	627	209	TM-915-3M	06	09	15	915	305
TM-633-3M	06	09	15	633	211	TM-945-3M	06	09	15	945	315
TM-639-3M	06	09	15	639	213	TM-951-3M	06	09	15	951	317
TM-645-3M	06	09	15	645	215	TM-981-3M	06	09	15	981	327
TM-648-3M	06	09	15	648	216	TM-1002-3M	06	09	15	1002	334
TM-654-3M	06	09	15	654	218	TM-1026-3M	06	09	15	1026	342
TM-657-3M	06	09	15	657	219	TM-1035-3M	06	09	15	1035	345
TM-663-3M	06	09	15	663	221	TM-1056-3M	06	09	15	1056	352
TM-669-3M	06	09	15	669	223	TM-1062-3M	06	09	15	1062	354
TM-672-3M	06	09	15	672	224	TM-1071-3M	06	09	15	1071	357
TM-681-3M	06	09	15	681	227	TM-1080-3M	06	09	15	1080	360
TM-684-3M	06	09	15	684	228	TM-1125-3M	06	09	15	1125	375
TM-687-3M	06	09	15	687	229	TM-1155-3M	06	09	15	1155	385
TM-696-3M	06	09	15	696	232	TM-1191-3M	06	09	15	1191	397
TM-711-3M	06	09	15	711	237	TM-1245-3M	06	09	15	1245	415
TM-720-3M	06	09	15	720	240	TM-1263-3M	06	09	15	1263	421
TM-735-3M	06	09	15	735	245	TM-1500-3M	06	09	15	1500	500
TM-738-3M	06	09	15	738	246	TM-1512-3M	06	09	15	1512	504
TM-753-3M	06	09	15	753	251	TM-1530-3M	06	09	15	1530	510
TM-795-3M	06	09	15	795	265	TM-1587-3M	06	09	15	1587	529
TM-804-3M	06	09	15	804	268	TM-1863-3M	06	09	15	1863	621
TM-822-3M	06	09	15	822	274	TM-1926-3M	06	09	15	1926	642
TM-837-3M	06	09	15	837	279	TM-1956-3M	06	09	15	1956	652
TM-843-3M	06	09	15	843	281	TM-2004-3M	06	09	15	2004	668

If you don't see the belt you need – call York!

5MM HTD



ALUMINUM WITH CLEAR ANODIZE (RoHS compliant)

FOR BELTS UP TO 9MM WIDE

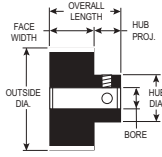

TYPE 6

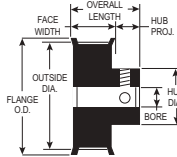

TYPE 6F



PART NUMBER	NO. OF GROOVES	PITCH DIA.	OUTSIDE DIA.	FLANGE O.D.	TYPE	BORE	FACE WIDTH	OVERALL LENGTH	HUB DIA.	SET SCREWS (2@90°)
14-5M-09 X 1/4	14	.877	.832	1.000	6F	.2500	.547	.790	.500	8-32
SAV-14-5M-09 X 1/4	14	.877	.832	1.000	6F	.2500	.547	.790	.500	8-32
15-5M-09 X 1/4	15	.940	.895	1.063	6F	.2500	.547	.790	.563	8-32
SAV-15-5M-09 X 1/4	15	.940	.895	1.063	6F	.2500	.547	.790	.563	8-32
16-5M-09 X 1/4	16	1.003	.958	1.094	6F	.2500	.547	.790	.563	8-32
SAV-16-5M-09 X 1/4	16	1.003	.958	1.094	6F	.2500	.547	.790	.563	8-32
17-5M-09 X 1/4	17	1.065	1.020	1.187	6F	.2500	.547	.790	.625	8-32
SAV-17-5M-09 X 1/4	17	1.065	1.020	1.187	6F	.2500	.547	.790	.625	8-32
18-5M-09 X 1/4	18	1.128	1.083	1.250	6F	.2500	.547	.790	.688	8-32
SAV-18-5M-09 X 1/4	18	1.128	1.083	1.250	6F	.2500	.547	.790	.688	8-32
19-5M-09 X 1/4	19	1.191	1.146	1.313	6F	.2500	.547	.790	.750	8-32
SAV-19-5M-09 X 1/4	19	1.191	1.146	1.313	6F	.2500	.547	.790	.750	8-32
20-5M-09 X 1/4	20	1.253	1.208	1.375	6F	.2500	.547	.790	.813	8-32
SAV-20-5M-09 X 1/4	20	1.253	1.208	1.375	6F	.2500	.547	.790	.813	8-32
22-5M-09 X 1/4	22	1.379	1.334	1.500	6F	.2500	.547	.790	.938	8-32
SAV-22-5M-09 X 1/4	22	1.379	1.334	1.500	6F	.2500	.547	.790	.938	8-32
24-5M-09 X 1/4	24	1.504	1.459	1.625	6F	.2500	.547	.852	1.000	8-32
SAV-24-5M-09 X 1/4	24	1.504	1.459	1.625	6F	.2500	.547	.852	1.000	8-32
26-5M-09 X 1/4	26	1.629	1.584	1.750	6F	.2500	.547	.852	1.063	8-32
SAV-26-5M-09 X 1/4	26	1.629	1.584	1.750	6F	.2500	.547	.852	1.063	8-32
28-5M-09 X 1/4	28	1.754	1.709	1.875	6F	.2500	.547	.852	1.188	8-32
SAV-28-5M-09 X 1/4	28	1.754	1.709	1.875	6F	.2500	.547	.852	1.188	8-32
30-5M-09 X 1/4	30	1.880	1.835	2.000	6F	.2500	.547	.852	1.188	8-32
SAV-30-5M-09 X 1/4	30	1.880	1.835	2.000	6F	.2500	.547	.852	1.188	8-32

“SAV.” in front of any standard timing pulley part # represents the Shaft-Saver version. Shaft-Saver pulleys have special setscrews that grip without damage to the shaft and allow easy pulley removal and realignment. For additional information, see our Shaft-Saver Engineering Section.

York also manufactures custom pulleys and complete assemblies
 email:support@york-ind.com web: www.york-ind.com



ALUMINUM WITH CLEAR ANODIZE (RoHS compliant)

FOR BELTS UP TO 9MM WIDE

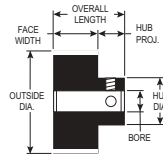

TYPE 6

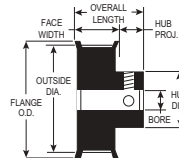

TYPE 6F

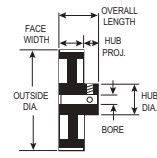

TYPE 6W

PART NUMBER	NO. OF GROOVES	PITCH DIA.	OUTSIDE DIA.	FLANGE O.D.	TYPE	BORE	FACE WIDTH	OVERALL LENGTH	HUB DIA.	SET SCREWS (2@90°)
32-5M-09 X 1/4	32	2.005	1.960	2.125	6F	.2500	.547	.852	1.250	8-32
SAV-32-5M-09 X 1/4	32	2.005	1.960	2.125	6F	.2500	.547	.852	1.250	8-32
34-5M-09 X 1/4	34	2.130	2.085	2.250	6F	.2500	.547	.852	1.375	8-32
SAV-34-5M-09 X 1/4	34	2.130	2.085	2.250	6F	.2500	.547	.852	1.375	8-32
36-5M-09 X 5/16	36	2.256	2.211	—	6	.3125	.547	.938	1.500	8-32
SAV-36-5M-09 X 5/16	36	2.256	2.211	—	6	.3125	.547	.938	1.500	8-32
38-5M-09 X 5/16	38	2.381	2.336	—	6	.3125	.547	.938	1.500	8-32
SAV-38-5M-09 X 5/16	38	2.381	2.336	—	6	.3125	.547	.938	1.500	8-32
40-5M-09 X 5/16	40	2.506	2.461	—	6	.3125	.547	.938	1.500	8-32
SAV-40-5M-09 X 5/16	40	2.506	2.461	—	6	.3125	.547	.938	1.500	8-32
44-5M-09 X 5/16	44	2.757	2.712	—	6W	.3125	.547	.938	1.500	8-32
SAV-44-5M-09 X 5/16	44	2.757	2.712	—	6W	.3125	.547	.938	1.500	8-32
50-5M-09 X 3/8	50	3.133	3.088	—	6W	.3750	.547	.938	1.500	10-32
SAV-50-5M-09 X 3/8	50	3.133	3.088	—	6W	.3750	.547	.938	1.500	10-32
56-3M-09 X 3/8	56	3.509	3.464	—	6W	.3750	.547	.938	1.500	10-32
SAV-56-3M-09 X 3/8	56	3.509	3.464	—	6W	.3750	.547	.938	1.500	10-32
62-5M-09 X 3/8	62	3.885	3.840	—	6W	.3750	.547	.938	1.500	10-32
SAV-62-5M-09 X 3/8	62	3.885	3.840	—	6W	.3750	.547	.938	1.500	10-32
72-5M-09 X 3/8	72	4.511	4.466	—	6W	.3750	.547	.938	1.500	10-32
SAV-72-5M-09 X 3/8	72	4.511	4.466	—	6W	.3750	.547	.938	1.500	10-32

“SAV-” in front of any standard timing pulley part # represents the Shaft-Saver version. Shaft-Saver pulleys have special setscrews that grip without damage to the shaft and allow easy pulley removal and realignment. For additional information, see our Shaft-Saver Engineering Section.

ALUMINUM WITH CLEAR ANODIZE (RoHS compliant)

FOR BELTS UP TO 15MM WIDE

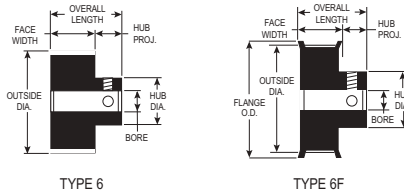

PART NUMBER	NO. OF GROOVES	PITCH DIA.	OUTSIDE DIA.	FLANGE O.D.	TYPE	BORE	FACE WIDTH	OVERALL LENGTH	HUB DIA.	SET SCREWS (2@90°)
14-5M-15 X 1/4	14	.877	.832	1.000	6F	.2500	.781	1.025	.500	8-32
SAV-14-5M-15 X 1/4	14	.877	.832	1.000	6F	.2500	.781	1.025	.500	8-32
15-5M-15 X 1/4	15	.940	.895	1.063	6F	.2500	.781	1.025	.563	8-32
SAV-15-5M-15 X 1/4	15	.940	.895	1.063	6F	.2500	.781	1.025	.563	8-32
16-5M-15 X 1/4	16	1.003	.958	1.094	6F	.2500	.781	1.025	.563	8-32
SAV-16-5M-15 X 1/4	16	1.003	.958	1.094	6F	.2500	.781	1.025	.563	8-32
17-5M-15 X 1/4	17	1.065	1.020	1.187	6F	.2500	.781	1.025	.625	8-32
SAV-17-5M-15 X 1/4	17	1.065	1.020	1.187	6F	.2500	.781	1.025	.625	8-32
18-5M-15 X 1/4	18	1.128	1.083	1.250	6F	.2500	.781	1.025	.688	8-32
SAV-18-5M-15 X 1/4	18	1.128	1.083	1.250	6F	.2500	.781	1.025	.688	8-32
19-5M-15 X 1/4	19	1.191	1.146	1.313	6F	.2500	.781	1.025	.750	8-32
SAV-19-5M-15 X 1/4	19	1.191	1.146	1.313	6F	.2500	.781	1.025	.750	8-32
20-5M-15 X 1/4	20	1.253	1.208	1.375	6F	.2500	.781	1.025	.813	8-32
SAV-20-5M-15 X 1/4	20	1.253	1.208	1.375	6F	.2500	.781	1.025	.813	8-32
22-5M-15 X 1/4	22	1.379	1.334	1.500	6F	.2500	.781	1.025	.938	8-32
SAV-22-5M-15 X 1/4	22	1.379	1.334	1.500	6F	.2500	.781	1.025	.938	8-32
24-5M-15 X 1/4	24	1.504	1.459	1.625	6F	.2500	.781	1.087	1.000	8-32
SAV-24-5M-15 X 1/4	24	1.504	1.459	1.625	6F	.2500	.781	1.087	1.000	8-32
26-5M-15 X 1/4	26	1.629	1.584	1.750	6F	.2500	.781	1.087	1.063	8-32
SAV-26-5M-15 X 1/4	26	1.629	1.584	1.750	6F	.2500	.781	1.087	1.063	8-32
28-5M-15 X 1/4	28	1.754	1.709	1.875	6F	.2500	.781	1.087	1.188	8-32
SAV-28-5M-15 X 1/4	28	1.754	1.709	1.875	6F	.2500	.781	1.087	1.188	8-32
30-5M-15 X 1/4	30	1.880	1.835	2.000	6F	.2500	.781	1.087	1.188	8-32
SAV-30-5M-15 X 1/4	30	1.880	1.835	2.000	6F	.2500	.781	1.087	1.188	8-32

“SAV.” in front of any standard timing pulley part # represents the Shaft-Saver version. Shaft-Saver pulleys have special setscrews that grip without damage to the shaft and allow easy pulley removal and realignment. For additional information, see our Shaft-Saver Engineering Section.

York also manufactures custom pulleys and complete assemblies
 email:support@york-ind.com web: www.york-ind.com



ALUMINUM WITH CLEAR ANODIZE (RoHS compliant)

FOR BELTS UP TO 15MM WIDE

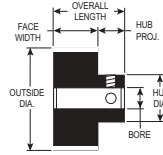

TYPE 6

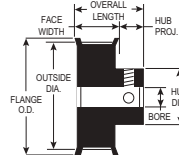

TYPE 6F

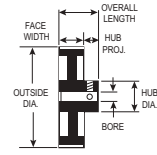

TYPE 6W

PART NUMBER	NO. OF GROOVES	PITCH DIA.	OUTSIDE DIA.	FLANGE O.D.	TYPE	BORE	FACE WIDTH	OVERALL LENGTH	HUB DIA.	SET SCREWS (2@90°)
32-5M-15 X 1/4	32	2.005	1.960	2.125	6F	.2500	.781	1.087	1.250	8-32
SAV-32-5M-15 X 1/4	32	2.005	1.960	2.125	6F	.2500	.781	1.087	1.250	8-32
34-5M-15 X 1/4	34	2.130	2.085	2.250	6F	.2500	.781	1.087	1.375	8-32
SAV-34-5M-15 X 1/4	34	2.130	2.085	2.250	6F	.2500	.781	1.087	1.375	8-32
36-5M-15 X 5/16	36	2.256	2.211	—	6	.3125	.781	1.094	1.500	8-32
SAV-36-5M-15 X 5/16	36	2.256	2.211	—	6	.3125	.781	1.094	1.500	8-32
38-5M-15 X 5/16	38	2.381	2.336	—	6	.3125	.781	1.094	1.500	8-32
SAV-38-5M-15 X 5/16	38	2.381	2.336	—	6	.3125	.781	1.094	1.500	8-32
40-5M-15 X 5/16	40	2.506	2.461	—	6	.3125	.781	1.094	1.500	8-32
SAV-40-5M-15 X 5/16	40	2.506	2.461	—	6	.3125	.781	1.094	1.500	8-32
44-5M-15 X 5/16	44	2.757	2.712	—	6W	.3125	.781	1.094	1.500	8-32
SAV-44-5M-15 X 5/16	44	2.757	2.712	—	6W	.3125	.781	1.094	1.500	8-32
50-5M-15 X 3/8	50	3.133	3.088	—	6W	.3750	.781	1.188	1.500	10-32
SAV-50-5M-15 X 3/8	50	3.133	3.088	—	6W	.3750	.781	1.188	1.500	10-32
56-5M-15 X 3/8	56	3.509	3.464	—	6W	.3750	.781	1.188	1.500	10-32
SAV-56-5M-15 X 3/8	56	3.509	3.464	—	6W	.3750	.781	1.188	1.500	10-32
62-5M-15 X 3/8	62	3.885	3.840	—	6W	.3750	.781	1.188	1.500	10-32
SAV-62-5M-15 X 3/8	62	3.885	3.840	—	6W	.3750	.781	1.188	1.500	10-32
72-5M-15 X 3/8	72	4.511	4.466	—	6W	.3750	.781	1.188	1.500	10-32
SAV-72-5M-15 X 3/8	72	4.511	4.466	—	6W	.3750	.781	1.188	1.500	10-32

“SAV-” in front of any standard timing pulley part # represents the Shaft-Saver version. Shaft-Saver pulleys have special setscrews that grip without damage to the shaft and allow easy pulley removal and realignment. For additional information, see our Shaft-Saver Engineering Section.

ALUMINUM 6061-T6 (RoHS compliant)

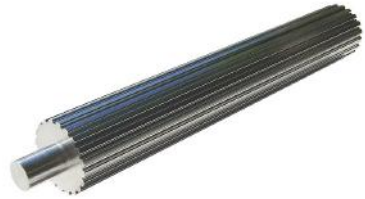
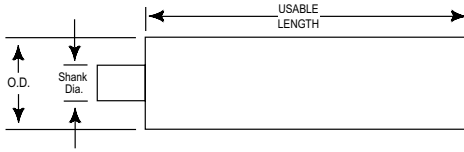

PART NUMBER	NO. OF GROOVES	PITCH DIA.	OUTSIDE DIA.	SHANK DIA.	USEABLE LENGTH
12-5M-P-6A	12	.753	.708	1/2	6"
13-5M-P-6A	13	.815	.770	1/2	6"
14-5M-P-7A	14	.877	.832	1/2	7"
15-5M-P-7A	15	.940	.895	1/2	7"
16-5M-P-7A	16	1.003	.958	1/2	7"
17-5M-P-7A	17	1.065	1.020	1/2	7"
18-5M-P-8A	18	1.128	1.083	1/2	8"
19-5M-P-8A	19	1.191	1.146	1/2	8"
20-5M-P-8A	20	1.253	1.208	1/2	8"
21-5M-P-8A	21	1.316	1.271	1/2	8"
22-5M-P-8A	22	1.379	1.334	1/2	8"
23-5M-P-8A	23	1.441	1.396	1/2	8"
24-5M-P-8A	24	1.504	1.459	1/2	8"
25-5M-P-8A	25	1.566	1.521	1/2	8"
26-5M-P-8A	26	1.629	1.584	1/2	8"
27-5M-P-8A	27	1.692	1.647	1/2	8"
28-5M-P-8A	28	1.754	1.709	1/2	8"
29-5M-P-8A	29	1.817	1.772	1/2	8"
30-5M-P-8A	30	1.880	1.835	1/2	8"
31-5M-P-8A	31	1.942	1.897	3/4	8"
32-5M-P-8A	32	2.005	1.960	3/4	8"

York also manufactures custom pulleys and complete assemblies
 email:support@york-ind.com web: www.york-ind.com



ALUMINUM 6061-T6 (RoHS compliant)

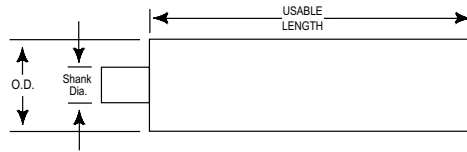
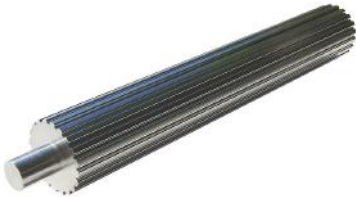

PART NUMBER	NO. OF GROOVES	PITCH DIA.	OUTSIDE DIA.	SHANK DIA.	USEABLE LENGTH
33-5M-P-8A	33	2.068	2.023	3/4	8"
34-5M-P-8A	34	2.130	2.085	3/4	8"
35-5M-P-8A	35	2.193	2.148	3/4	8"
36-5M-P-8A	36	2.256	2.211	3/4	8"
38-5M-P-8A	38	2.381	2.336	3/4	8"
40-5M-P-8A	40	2.506	2.461	3/4	8"
42-5M-P-8A	42	2.632	2.587	3/4	8"
44-5M-P-8A	44	2.757	2.712	3/4	8"
45-5M-P-8A	45	2.820	2.775	3/4	8"
46-5M-P-8A	46	2.882	2.837	3/4	8"
48-5M-P-8A	48	3.008	2.963	3/4	8"
50-5M-P-8A	50	3.133	3.088	3/4	8"
54-5M-P-8A	54	3.384	3.339	3/4	8"
60-5M-P-8A	60	3.760	3.715	3/4	8"
62-5M-P-8A	62	3.885	3.840	3/4	8"
72-5M-P-8A	72	4.511	4.466	1	8"
80-5M-P-8A	80	5.013	4.968	1	8"
90-5M-P-8A	90	5.639	5.594	1	8"
100-5M-P-6A	100	6.266	6.221	1	6"
112-5M-P-6A	112	7.018	6.973	1	6"
126-5M-P-6A	126	7.895	7.850	1	6"

STEEL (RoHS compliant)

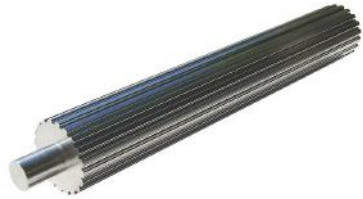
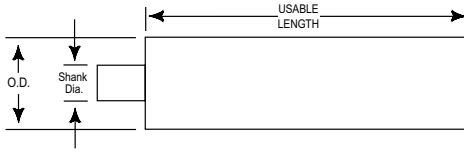

PART NUMBER	NO. OF GROOVES	PITCH DIA.	OUTSIDE DIA.	SHANK DIA.	USEABLE LENGTH
12-5M-P-6S	12	.753	.708	1/2	6"
13-5M-P-6S	13	.815	.770	1/2	6"
14-5M-P-7S	14	.877	.832	1/2	7"
15-5M-P-7S	15	.940	.895	1/2	7"
16-5M-P-7S	16	1.003	.958	1/2	7"
17-5M-P-7S	17	1.065	1.020	1/2	7"
18-5M-P-8S	18	1.128	1.083	1/2	8"
19-5M-P-8S	19	1.191	1.146	1/2	8"
20-5M-P-8S	20	1.253	1.208	1/2	8"
21-5M-P-8S	21	1.316	1.271	1/2	8"
22-5M-P-8S	22	1.379	1.334	1/2	8"
23-5M-P-8S	23	1.441	1.396	1/2	8"
24-5M-P-8S	24	1.504	1.459	1/2	8"
25-5M-P-8S	25	1.566	1.521	1/2	8"
26-5M-P-8S	26	1.629	1.584	1/2	8"
27-5M-P-8S	27	1.692	1.647	1/2	8"
28-5M-P-8S	28	1.754	1.709	1/2	8"
29-5M-P-8S	29	1.817	1.772	1/2	8"
30-5M-P-8S	30	1.880	1.835	1/2	8"

York also manufactures custom pulleys and complete assemblies
 email: support@york-ind.com web: www.york-ind.com



STEEL (RoHS compliant)

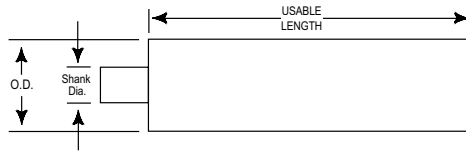
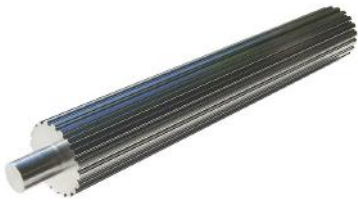

PART NUMBER	NO. OF GROOVES	PITCH DIA.	OUTSIDE DIA.	SHANK DIA.	USEABLE LENGTH
31-5M-P-8S	31	1.942	1.897	3/4	8"
32-5M-P-8S	32	2.005	1.960	3/4	8"
33-5M-P-8S	33	2.068	2.023	3/4	8"
34-5M-P-8S	34	2.130	2.085	3/4	8"
35-5M-P-8S	35	2.193	2.148	3/4	8"
36-5M-P-8S	36	2.256	2.211	3/4	8"
38-5M-P-8S	38	2.381	2.336	3/4	8"
40-5M-P-8S	40	2.506	2.461	3/4	8"
42-5M-P-8S	42	2.632	2.587	3/4	8"
44-5M-P-8S	44	2.757	2.712	3/4	8"
45-5M-P-8S	45	2.820	2.775	3/4	8"
48-5M-P-8S	48	3.008	2.963	3/4	8"
50-5M-P-8S	50	3.133	3.088	3/4	8"
60-5M-P-8S	60	3.760	3.715	3/4	8"
72-5M-P-8S	72	4.511	4.466	1	8"
80-5M-P-8S	80	5.013	4.968	1	8"
90-5M-P-8S	90	5.639	5.594	1	8"

ALUMINUM (RoHS compliant)

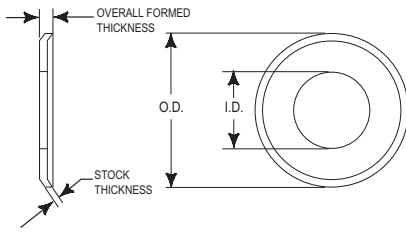

PART NUMBER	INSIDE DIA.	OUTSIDE DIA.	STOCK THICKNESS	OVERALL FORMED THICKNESS
12-5M-F7A	.503	.875	.040	.065
13-5M-F7A	.562	.937	.040	.065
14-5M-F7A	.562	1.000	.040	.065
15-5M-F7A	.625	1.062	.040	.065
16-5M-F7A	.684	1.093	.040	.065
17-5M-F7A	.748	1.187	.040	.065
18-5M-F7A	.810	1.250	.040	.065
19-5M-F7A	.887	1.312	.040	.065
20-5M-F7A	.936	1.375	.040	.065
21-5M-F7A	1.000	1.437	.040	.065
22-5M-F7A	1.062	1.500	.040	.065
23-5M-F7A	1.125	1.562	.040	.065
24-5M-F7A	1.160	1.625	.040	.065
25-5M-F7A	1.223	1.687	.040	.065
26-5M-F7A	1.222	1.750	.040	.065
28-5M-F7A	1.347	1.875	.040	.065
30-5M-F7A	1.425	2.000	.040	.065
32-5M-F7A	1.550	2.125	.040	.065
34-5M-F7A	1.675	2.250	.040	.065

York also manufactures custom pulleys and complete assemblies
 email: support@york-ind.com web: www.york-ind.com



STEEL (RoHS compliant)

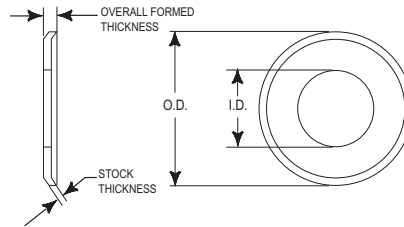

PART NUMBER	INSIDE DIA.	OUTSIDE DIA.	STOCK THICKNESS	OVERALL FORMED THICKNESS
12-5M-F8S	.503	.875	.040	.065
13-5M-F8S	.562	.937	.040	.065
14-5M-F8S	.562	1.000	.040	.065
15-5M-F8S	.625	1.062	.040	.065
16-5M-F8S	.684	1.093	.040	.065
17-5M-F8S	.748	1.187	.040	.065
18-5M-F8S	.810	1.250	.040	.065
19-5M-F8S	.887	1.312	.040	.065
20-5M-F8S	.936	1.375	.040	.065
21-5M-F8S	1.000	1.437	.040	.065
22-5M-F8S	1.062	1.500	.040	.065
23-5M-F8S	1.125	1.562	.040	.065
24-5M-F8S	1.160	1.625	.040	.065
25-5M-F8S	1.223	1.687	.040	.065
26-5M-F8S	1.222	1.750	.040	.065
28-5M-F8S	1.347	1.875	.040	.065
30-5M-F8S	1.425	2.000	.040	.065
32-5M-F8S	1.550	2.125	.040	.065
34-5M-F8S	1.675	2.250	.040	.065

BLACK NEOPRENE, Fiberglass Cord (RoHS compliant)

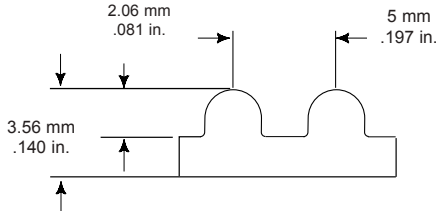

BELT NUMBER	9MM	WIDTHS 15MM	25MM	PITCH LENGTH (MM)	NO. OF TEETH	BELT NUMBER	9MM	WIDTHS 15MM	25MM	PITCH LENGTH (MM)	NO. OF TEETH
180-5M	09	15	25	180	36	450-5M	09	15	25	450	90
200-5M	09	15	25	200	40	460-5M	09	15	25	460	92
225-5M	09	15	25	225	45	475-5M	09	15	25	475	95
240-5M	09	15	25	240	48	480-5M	09	15	25	480	96
255-5M	09	15	25	255	51	495-5M	09	15	25	495	99
260-5M	09	15	25	260	52	500-5M	09	15	25	500	100
265-5M	09	15	25	265	53	520-5M	09	15	25	520	104
270-5M	09	15	25	270	54	525-5M	09	15	25	525	105
275-5M	09	15	25	275	55	535-5M	09	15	25	535	107
280-5M	09	15	25	280	56	550-5M	09	15	25	550	110
285-5M	09	15	25	285	57	555-5M	09	15	25	555	111
295-5M	09	15	25	295	59	560-5M	09	15	25	560	112
300-5M	09	15	25	300	60	565-5M	09	15	25	565	113
305-5M	09	15	25	305	61	575-5M	09	15	25	575	115
310-5M	09	15	25	310	62	580-5M	09	15	25	580	116
320-5M	09	15	25	320	64	585-5M	09	15	25	585	117
325-5M	09	15	25	325	65	590-5M	09	15	25	590	118
330-5M	09	15	25	330	66	600-5M	09	15	25	600	120
335-5M	09	15	25	335	67	610-5M	09	15	25	610	122
340-5M	09	15	25	340	68	615-5M	09	15	25	615	123
345-5M	09	15	25	345	69	635-5M	09	15	25	635	127
350-5M	09	15	25	350	70	640-5M	09	15	25	640	128
360-5M	09	15	25	360	72	645-5M	09	15	25	645	129
365-5M	09	15	25	365	73	655-5M	09	15	25	655	131
370-5M	09	15	25	370	74	665-5M	09	15	25	665	133
375-5M	09	15	25	375	75	670-5M	09	15	25	670	134
385-5M	09	15	25	385	77	680-5M	09	15	25	680	136
400-5M	09	15	25	400	80	685-5M	09	15	25	685	137
405-5M	09	15	25	405	81	695-5M	09	15	25	695	139
415-5M	09	15	25	415	83	700-5M	09	15	25	700	140
425-5M	09	15	25	425	85	710-5M	09	15	25	710	142

Need a clean, low dust belt? See TruMotion belts.

York also manufactures custom pulleys and complete assemblies
 email: support@york-ind.com web: www.york-ind.com



BLACK NEOPRENE, Fiberglass Cord (RoHS compliant)

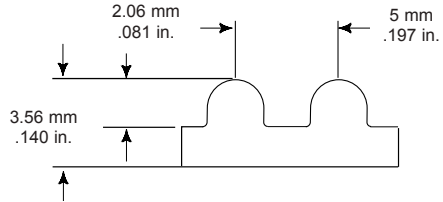

BELT NUMBER	9MM	WIDTHS 15MM	25MM	PITCH LENGTH (MM)	NO. OF TEETH	BELT NUMBER	9MM	WIDTHS 15MM	25MM	PITCH LENGTH (MM)	NO. OF TEETH
740-5M	09	15	25	740	148	1135-5M	09	15	25	1135	227
745-5M	09	15	25	745	149	1175-5M	09	15	25	1175	235
750-5M	09	15	25	750	150	1195-5M	09	15	25	1195	239
755-5M	09	15	25	755	151	1200-5M	09	15	25	1200	240
765-5M	09	15	25	765	153	1225-5M	09	15	25	1225	245
770-5M	09	15	25	770	154	1250-5M	09	15	25	1250	250
775-5M	09	15	25	775	155	1270-5M	09	15	25	1270	254
790-5M	09	15	25	790	158	1295-5M	09	15	25	1295	259
800-5M	09	15	25	800	160	1350-5M	09	15	25	1350	270
825-5M	09	15	25	825	165	1375-5M	09	15	25	1375	275
830-5M	09	15	25	830	166	1420-5M	09	15	25	1420	284
835-5M	09	15	25	835	167	1575-5M	09	15	25	1575	315
850-5M	09	15	25	850	170	1595-5M	09	15	25	1595	319
860-5M	09	15	25	860	172	1635-5M	09	15	25	1635	327
870-5M	09	15	25	870	174	1690-5M	09	15	25	1690	338
890-5M	09	15	25	890	178	1720-5M	09	15	25	1720	344
900-5M	09	15	25	900	180	1790-5M	09	15	25	1790	358
925-5M	09	15	25	925	185	1800-5M	09	15	25	1800	360
935-5M	09	15	25	935	187	1870-5M	09	15	25	1870	374
940-5M	09	15	25	940	188	1895-5M	09	15	25	1895	379
950-5M	09	15	25	950	190	1945-5M	09	15	25	1945	389
965-5M	09	15	25	965	193	1980-5M	09	15	25	1980	396
975-5M	09	15	25	975	195	2000-5M	09	15	25	2000	400
980-5M	09	15	25	980	196	2100-5M	09	15	25	2100	420
985-5M	09	15	25	985	197	2110-5M	09	15	25	2110	422
1000-5M	09	15	25	1000	200	2250-5M	09	15	25	2250	450
1025-5M	09	15	25	1025	205	2350-5M	09	15	25	2350	470
1035-5M	09	15	25	1035	207	2525-5M	09	15	25	2525	505
1050-5M	09	15	25	1050	210	2760-5M	09	15	25	2760	552
1100-5M	09	15	25	1100	220	3120-5M	09	15	25	3120	624
1125-5M	09	15	25	1125	225	3800-5M	09	15	25	3800	760

If you don't see the belt you need – call York!

Cream Colored Engineered Polymer with Fiberglass Cord (RoHS compliant)

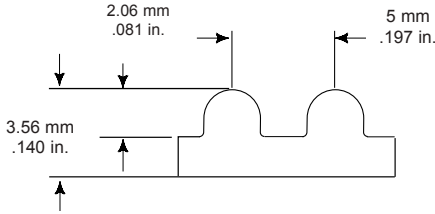

BELT NUMBER	WIDTHS			PITCH LENGTH (MM)	NO. OF TEETH	BELT NUMBER	WIDTHS			PITCH LENGTH (MM)	NO. OF TEETH
	9MM	15MM	25MM				9MM	15MM	25MM		
TM-180-5M	09	15	25	180	36	TM-450-5M	09	15	25	450	90
TM-200-5M	09	15	25	200	40	TM-460-5M	09	15	25	460	92
TM-225-5M	09	15	25	225	45	TM-475-5M	09	15	25	475	95
TM-240-5M	09	15	25	240	48	TM-480-5M	09	15	25	480	96
TM-255-5M	09	15	25	255	51	TM-495-5M	09	15	25	495	99
TM-260-5M	09	15	25	260	52	TM-500-5M	09	15	25	500	100
TM-265-5M	09	15	25	265	53	TM-520-5M	09	15	25	520	104
TM-270-5M	09	15	25	270	54	TM-525-5M	09	15	25	525	105
TM-275-5M	09	15	25	275	55	TM-535-5M	09	15	25	535	107
TM-280-5M	09	15	25	280	56	TM-550-5M	09	15	25	550	110
TM-285-5M	09	15	25	285	57	TM-555-5M	09	15	25	555	111
TM-295-5M	09	15	25	295	59	TM-560-5M	09	15	25	560	112
TM-300-5M	09	15	25	300	60	TM-565-5M	09	15	25	565	113
TM-305-5M	09	15	25	305	61	TM-575-5M	09	15	25	575	115
TM-310-5M	09	15	25	310	62	TM-580-5M	09	15	25	580	116
TM-320-5M	09	15	25	320	64	TM-585-5M	09	15	25	585	117
TM-325-5M	09	15	25	325	65	TM-590-5M	09	15	25	590	118
TM-330-5M	09	15	25	330	66	TM-600-5M	09	15	25	600	120
TM-335-5M	09	15	25	335	67	TM-610-5M	09	15	25	610	122
TM-340-5M	09	15	25	340	68	TM-615-5M	09	15	25	615	123
TM-345-5M	09	15	25	345	69	TM-635-5M	09	15	25	635	127
TM-350-5M	09	15	25	350	70	TM-640-5M	09	15	25	640	128
TM-360-5M	09	15	25	360	72	TM-645-5M	09	15	25	645	129
TM-365-5M	09	15	25	365	73	TM-655-5M	09	15	25	655	131
TM-370-5M	09	15	25	370	74	TM-665-5M	09	15	25	665	133
TM-375-5M	09	15	25	375	75	TM-670-5M	09	15	25	670	134
TM-385-5M	09	15	25	385	77	TM-680-5M	09	15	25	680	136
TM-400-5M	09	15	25	400	80	TM-685-5M	09	15	25	685	137
TM-405-5M	09	15	25	405	81	TM-695-5M	09	15	25	695	139
TM-415-5M	09	15	25	415	83	TM-700-5M	09	15	25	700	140
TM-425-5M	09	15	25	425	85	TM-710-5M	09	15	25	710	142

If you don't see the belt you need – call York!

York also manufactures custom pulleys and complete assemblies
 email: support@york-ind.com web: www.york-ind.com



Cream Colored Engineered Polymer with Fiberglass Cord (RoHS compliant)

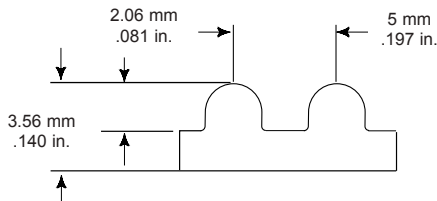

BELT NUMBER	WIDTHS			PITCH LENGTH (MM)	NO. OF TEETH	BELT NUMBER	WIDTHS			PITCH LENGTH (MM)	NO. OF TEETH
	9MM	15MM	25MM				9MM	15MM	25MM		
TM-740-5M	09	15	25	740	148	TM-1135-5M	09	15	25	1135	227
TM-745-5M	09	15	25	745	149	TM-1175-5M	09	15	25	1175	235
TM-750-5M	09	15	25	750	150	TM-1195-5M	09	15	25	1195	239
TM-755-5M	09	15	25	755	151	TM-1200-5M	09	15	25	1200	240
TM-765-5M	09	15	25	765	153	TM-1225-5M	09	15	25	1225	245
TM-770-5M	09	15	25	770	154	TM-1250-5M	09	15	25	1250	250
TM-775-5M	09	15	25	775	155	TM-1270-5M	09	15	25	1270	254
TM-790-5M	09	15	25	790	158	TM-1295-5M	09	15	25	1295	259
TM-800-5M	09	15	25	800	160	TM-1350-5M	09	15	25	1350	270
TM-825-5M	09	15	25	825	165	TM-1375-5M	09	15	25	1375	275
TM-830-5M	09	15	25	830	166	TM-1420-5M	09	15	25	1420	284
TM-835-5M	09	15	25	835	167	TM-1575-5M	09	15	25	1575	315
TM-850-5M	09	15	25	850	170	TM-1595-5M	09	15	25	1595	319
TM-860-5M	09	15	25	860	172	TM-1635-5M	09	15	25	1635	327
TM-870-5M	09	15	25	870	174	TM-1690-5M	09	15	25	1690	338
TM-890-5M	09	15	25	890	178	TM-1720-5M	09	15	25	1720	344
TM-900-5M	09	15	25	900	180	TM-1790-5M	09	15	25	1790	358
TM-925-5M	09	15	25	925	185	TM-1800-5M	09	15	25	1800	360
TM-935-5M	09	15	25	935	187	TM-1870-5M	09	15	25	1870	374
TM-940-5M	09	15	25	940	188	TM-1895-5M	09	15	25	1895	379
TM-950-5M	09	15	25	950	190	TM-1945-5M	09	15	25	1945	389
TM-965-5M	09	15	25	965	193	TM-1980-5M	09	15	25	1980	396
TM-975-5M	09	15	25	975	195	TM-2000-5M	09	15	25	2000	400
TM-980-5M	09	15	25	980	196	TM-2100-5M	09	15	25	2100	420
TM-985-5M	09	15	25	985	197	TM-2110-5M	09	15	25	2110	422
TM-1000-5M	09	15	25	1000	200	TM-2250-5M	09	15	25	2250	450
TM-1025-5M	09	15	25	1025	205	TM-2350-5M	09	15	25	2350	470
TM-1035-5M	09	15	25	1035	207	TM-2525-5M	09	15	25	2525	505
TM-1050-5M	09	15	25	1050	210	TM-2760-5M	09	15	25	2760	552
TM-1100-5M	09	15	25	1100	220	TM-3120-5M	09	15	25	3120	624
TM-1125-5M	09	15	25	1125	225	TM-3800-5M	09	15	25	3800	760

If you don't see the belt you need – call York!



1/5 (XL)

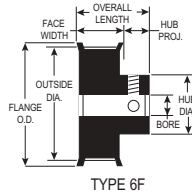

PART NUMBER	NO. OF GROOVES	PITCH DIA.	OUTSIDE DIA.	FLANGE O.D.	TYPE	BORE (+.001 / -.000)	FACE WIDTH	OVERALL LENGTH	HUB PROJ.	HUB DIA.	SET SCREWS
10XL025-1A X 3/16	10	.637	.617	7/8	6F	.1875	7/16	11/16	1/4	3/8	6-40(1)
SAV-10XL025-1A X 3/16	10	.637	.617	7/8	6F	.1875	7/16	11/16	1/4	3/8	6-40(1)
11XL025-1A X 3/16	11	.700	.680	15/16	6F	.1875	7/16	11/16	1/4	7/16	6-40(1)
SAV-11XL025-1A X 3/16	11	.700	.680	15/16	6F	.1875	7/16	11/16	1/4	7/16	6-40(1)
11XL025-1A X 1/4	11	.700	.680	15/16	6F	.2500	7/16	11/16	1/4	7/16	8-32(1)
SAV-11XL025-1A X 1/4	11	.700	.680	15/16	6F	.2500	7/16	11/16	1/4	7/16	8-32(1)
12XL025-1A X 3/16	12	.764	.744	1	6F	.1875	7/16	11/16	1/4	1/2	6-40(2)
SAV-12XL025-1A X 3/16	12	.764	.744	1	6F	.1875	7/16	11/16	1/4	1/2	6-40(2)
12XL025-1A X 1/4	12	.764	.744	1	6F	.2500	7/16	11/16	1/4	1/2	8-32(2)
SAV-12XL025-1A X 1/4	12	.764	.744	1	6F	.2500	7/16	11/16	1/4	1/2	8-32(2)
13XL025-1A X 1/4	13	.828	.808	1 1/16	6F	.2500	7/16	11/16	1/4	9/16	8-32(2)
SAV-13XL025-1A X 1/4	13	.828	.808	1 1/16	6F	.2500	7/16	11/16	1/4	9/16	8-32(2)
14XL025-1A X 1/4	14	.891	.871	1 3/32	6F	.2500	7/16	11/16	1/4	9/16	8-32(2)
SAV-14XL025-1A X 1/4	14	.891	.871	1 3/32	6F	.2500	7/16	11/16	1/4	9/16	8-32(2)
14XL025-1A X 5/16	14	.891	.871	1 3/32	6F	.3125	7/16	11/16	1/4	9/16	8-32(2)
SAV-14XL025-1A X 5/16	14	.891	.871	1 3/32	6F	.3125	7/16	11/16	1/4	9/16	8-32(2)
15XL025-1A X 1/4	15	.955	.935	1 3/16	6F	.2500	7/16	11/16	1/4	5/8	8-32(2)
SAV-15XL025-1A X 1/4	15	.955	.935	1 3/16	6F	.2500	7/16	11/16	1/4	5/8	8-32(2)
15XL025-1A X 5/16	15	.955	.935	1 3/16	6F	.3125	7/16	11/16	1/4	5/8	8-32(2)
SAV-15XL025-1A X 5/16	15	.955	.935	1 3/16	6F	.3125	7/16	11/16	1/4	5/8	8-32(2)
16XL025-1A X 1/4	16	1.019	.999	1 1/4	6F	.2500	7/16	11/16	1/4	11/16	8-32(2)
SAV-16XL025-1A X 1/4	16	1.019	.999	1 1/4	6F	.2500	7/16	11/16	1/4	11/16	8-32(2)
16XL025-1A X 5/16	16	1.019	.999	1 1/4	6F	.3125	7/16	11/16	1/4	11/16	8-32(2)
SAV-16XL025-1A X 5/16	16	1.019	.999	1 1/4	6F	.3125	7/16	11/16	1/4	11/16	8-32(2)
18XL025-1A X 1/4	18	1.146	1.126	1 3/8	6F	.2500	7/16	11/16	1/4	13/16	8-32(2)
SAV-18XL025-1A X 1/4	18	1.146	1.126	1 3/8	6F	.2500	7/16	11/16	1/4	13/16	8-32(2)
18XL025-1A X 5/16	18	1.146	1.126	1 3/8	6F	.3125	7/16	11/16	1/4	13/16	8-32(2)
SAV-18XL025-1A X 5/16	18	1.146	1.126	1 3/8	6F	.3125	7/16	11/16	1/4	13/16	8-32(2)

“SAV.” in front of any standard timing pulley part # represents the Shaft-Saver version. Shaft-Saver pulleys have special setscrews that grip without damage to the shaft and allow easy pulley removal and realignment. For additional information, see our Shaft-Saver Engineering Section.

ALUMINUM WITH CLEAR ANODIZE (RoHS compliant)

FOR BELTS UP TO 1/4" WIDE

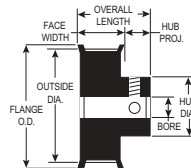

TYPE 6F

PART NUMBER	NO. OF GROOVES	PITCH DIA.	OUTSIDE DIA.	FLANGE O.D.	TYPE	BORE (+.001) (-.000)	FACE WIDTH	OVERALL LENGTH	HUB PROJ.	HUB DIA.	SET SCREWS
20XL025-1A X 1/4	20	1.273	1.253	1 1/2	6F	.2500	7/16	3/4	5/16	15/16	8-32(2)
SAV-20XL025-1A X 1/4	20	1.273	1.253	1 1/2	6F	.2500	7/16	3/4	5/16	15/16	8-32(2)
20XL025-1A X 5/16	20	1.273	1.253	1 1/2	6F	.3125	7/16	3/4	5/16	15/16	8-32(2)
SAV-20XL025-1A X 5/16	20	1.273	1.253	1 1/2	6F	.3125	7/16	3/4	5/16	15/16	8-32(2)
21XL025-1A X 1/4	21	1.337	1.317	1 9/16	6F	.2500	7/16	3/4	5/16	1	8-32(2)
SAV-21XL025-1A X 1/4	21	1.337	1.317	1 9/16	6F	.2500	7/16	3/4	5/16	1	8-32(2)
21XL025-1A X 5/16	21	1.337	1.317	1 9/16	6F	.3125	7/16	3/4	5/16	1	8-32(2)
SAV-21XL025-1A X 5/16	21	1.337	1.317	1 9/16	6F	.3125	7/16	3/4	5/16	1	8-32(2)
22XL025-1A X 1/4	22	1.401	1.381	1 5/8	6F	.2500	7/16	3/4	5/16	1	8-32(2)
SAV-22XL025-1A X 1/4	22	1.401	1.381	1 5/8	6F	.2500	7/16	3/4	5/16	1	8-32(2)
22XL025-1A X 3/8	22	1.401	1.381	1 5/8	6F	.3750	7/16	3/4	5/16	1	10-32(2)
SAV-22XL025-1A X 3/8	22	1.401	1.381	1 5/8	6F	.3750	7/16	3/4	5/16	1	10-32(2)
24XL025-1A X 1/4	24	1.528	1.508	1 3/4	6F	.2500	7/16	25/32	11/32	1 1/16	8-32(2)
SAV-24XL025-1A X 1/4	24	1.528	1.508	1 3/4	6F	.2500	7/16	25/32	11/32	1 1/16	8-32(2)
24XL025-1A X 5/16	24	1.528	1.508	1 3/4	6F	.3125	7/16	25/32	11/32	1 1/16	8-32(2)
SAV-24XL025-1A X 5/16	24	1.528	1.508	1 3/4	6F	.3125	7/16	25/32	11/32	1 1/16	8-32(2)
24XL025-1A X 3/8	24	1.528	1.508	1 3/4	6F	.3750	7/16	25/32	11/32	1 1/16	10-32(2)
SAV-24XL025-1A X 3/8	24	1.528	1.508	1 3/4	6F	.3750	7/16	25/32	11/32	1 1/16	10-32(2)
26XL025-1A X 1/4	26	1.655	1.635	1 7/8	6F	.2500	7/16	25/32	11/32	1 3/16	8-32(2)
SAV-26XL025-1A X 1/4	26	1.655	1.635	1 7/8	6F	.2500	7/16	25/32	11/32	1 3/16	8-32(2)
26XL025-1A X 3/8	26	1.655	1.635	1 7/8	6F	.3750	7/16	25/32	11/32	1 3/16	10-32(2)
SAV-26XL025-1A X 3/8	26	1.655	1.635	1 7/8	6F	.3750	7/16	25/32	11/32	1 3/16	10-32(2)
28XL025-1A X 1/4	28	1.783	1.763	2	6F	.2500	7/16	25/32	11/32	1 3/16	8-32(2)
SAV-28XL025-1A X 1/4	28	1.783	1.763	2	6F	.2500	7/16	25/32	11/32	1 3/16	8-32(2)
28XL025-1A X 3/8	28	1.783	1.763	2	6F	.3750	7/16	25/32	11/32	1 3/16	10-32(2)
SAV-28XL025-1A X 3/8	28	1.783	1.763	2	6F	.3750	7/16	25/32	11/32	1 3/16	10-32(2)
30XL025-1A X 1/4	30	1.910	1.890	2 1/8	6F	.2500	7/16	25/32	11/32	1 5/16	8-32(2)
SAV-30XL025-1A X 1/4	30	1.910	1.890	2 1/8	6F	.2500	7/16	25/32	11/32	1 5/16	8-32(2)
30XL025-1A X 3/8	30	1.910	1.890	2 1/8	6F	.3750	7/16	25/32	11/32	1 5/16	10-32(2)
SAV-30XL025-1A X 3/8	30	1.910	1.890	2 1/8	6F	.3750	7/16	25/32	11/32	1 5/16	10-32(2)

"SAV-" in front of any standard timing pulley part # represents the Shaft-Saver version. Shaft-Saver pulleys have special setscrews that grip without damage to the shaft and allow easy pulley removal and realignment. For additional information, see our Shaft-Saver Engineering Section.

ALUMINUM WITH CLEAR ANODIZE (RoHS compliant)

FOR BELTS UP TO 3/8" WIDE

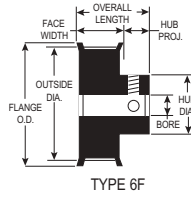

PART NUMBER	NO. OF GROOVES	PITCH DIA.	OUTSIDE DIA.	FLANGE O.D.	TYPE	BORE (+.001 / -.000)	FACE WIDTH	OVERALL LENGTH	HUB PROJ.	HUB DIA.	SET SCREWS
10XL037-1A X 3/16	10	.637	.617	7/8	6F	.1875	9/16	13/16	1/4	7/16	6-40(1)
SAV-10XL037-1A X 3/16	10	.637	.617	7/8	6F	.1875	9/16	13/16	1/4	7/16	6-40(1)
10XL037-1A X 1/4	10	.637	.617	7/8	6F	.2500	9/16	13/16	1/4	7/16	8-32(1)
SAV-10XL037-1A X 1/4	10	.637	.617	7/8	6F	.2500	9/16	13/16	1/4	7/16	8-32(1)
11XL037-1A X 3/16	11	.700	.680	15/16	6F	.1875	9/16	13/16	1/4	1/2	6-40(1)
SAV-11XL037-1A X 3/16	11	.700	.680	15/16	6F	.1875	9/16	13/16	1/4	1/2	6-40(1)
11XL037-1A X 1/4	11	.700	.680	15/16	6F	.2500	9/16	13/16	1/4	1/2	8-32(1)
SAV-11XL037-1A X 1/4	11	.700	.680	15/16	6F	.2500	9/16	13/16	1/4	1/2	8-32(1)
12XL037-1A X 3/16	12	.764	.744	1	6F	.1875	9/16	13/16	1/4	1/2	6-40(2)
SAV-12XL037-1A X 3/16	12	.764	.744	1	6F	.1875	9/16	13/16	1/4	1/2	6-40(2)
12XL037-1A X 1/4	12	.764	.744	1	6F	.2500	9/16	13/16	1/4	1/2	8-32(2)
SAV-12XL037-1A X 1/4	12	.764	.744	1	6F	.2500	9/16	13/16	1/4	1/2	8-32(2)
12XL037-1A X 5/16	12	.764	.744	1	6F	.3125	9/16	13/16	1/4	1/2	6-40(2)
SAV-12XL037-1A X 5/16	12	.764	.744	1	6F	.3125	9/16	13/16	1/4	1/2	6-40(2)
13XL037-1A X 1/4	13	.828	.808	1 1/16	6F	.2500	9/16	13/16	1/4	9/16	8-32(2)
SAV-13XL037-1A X 1/4	13	.828	.808	1 1/16	6F	.2500	9/16	13/16	1/4	9/16	8-32(2)
14XL037-1A X 1/4	14	.891	.871	1 3/32	6F	.2500	9/16	13/16	1/4	9/16	8-32(2)
SAV-14XL037-1A X 1/4	14	.891	.871	1 3/32	6F	.2500	9/16	13/16	1/4	9/16	8-32(2)
14XL037-1A X 5/16	14	.891	.871	1 3/32	6F	.3125	9/16	13/16	1/4	9/16	8-32(2)
SAV-14XL037-1A X 5/16	14	.891	.871	1 3/32	6F	.3125	9/16	13/16	1/4	9/16	8-32(2)
15XL037-1A X 1/4	15	.955	.935	1 3/16	6F	.2500	9/16	13/16	1/4	5/8	8-32(2)
SAV-15XL037-1A X 1/4	15	.955	.935	1 3/16	6F	.2500	9/16	13/16	1/4	5/8	8-32(2)
15XL037-1A X 5/16	15	.955	.935	1 3/16	6F	.3125	9/16	13/16	1/4	5/8	8-32(2)
SAV-15XL037-1A X 5/16	15	.955	.935	1 3/16	6F	.3125	9/16	13/16	1/4	5/8	8-32(2)
15XL037-1A X 3/8	15	.955	.935	1 3/16	6F	.3750	9/16	13/16	1/4	3/4	8-32(2)
SAV-15XL037-1A X 3/8	15	.955	.935	1 3/16	6F	.3750	9/16	13/16	1/4	3/4	8-32(2)
15XL037-1A X 1/2	15	.955	.935	1 3/16	6F	.5000	9/16	13/16	1/4	3/4	8-32(2)
SAV-15XL037-1A X 1/2	15	.955	.935	1 3/16	6F	.5000	9/16	13/16	1/4	3/4	8-32(2)
16XL037-1A X 1/4	16	1.019	.999	1 1/4	6F	.2500	9/16	13/16	1/4	11/16	8-32(2)
SAV-16XL037-1A X 1/4	16	1.019	.999	1 1/4	6F	.2500	9/16	13/16	1/4	11/16	8-32(2)

“SAV.” in front of any standard timing pulley part # represents the Shaft-Saver version. Shaft-Saver pulleys have special setscrews that grip without damage to the shaft and allow easy pulley removal and realignment. For additional information, see our Shaft-Saver Engineering Section.

York also manufactures custom pulleys and complete assemblies
 email:support@york-ind.com web: www.york-ind.com



ALUMINUM WITH CLEAR ANODIZE (RoHS compliant)

FOR BELTS UP TO 3/8" WIDE

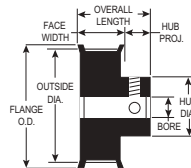

TYPE 6F

PART NUMBER	NO OF GROOVES	PITCH DIA.	OUTSIDE DIA.	FLANGE O.D.	TYPE	BORE (+.001) (-.000)	FACE WIDTH	OVERALL LENGTH	HUB PROJ.	HUB DIA.	SET SCREWS
16XL037-1A X 5/16	16	1.019	.999	1 1/4	6F	.3125	9/16	13/16	1/4	11/16	8-32(2)
SAV-16XL037-1A X 5/16	16	1.019	.999	1 1/4	6F	.3125	9/16	13/16	1/4	11/16	8-32(2)
16XL037-1A X 3/8	16	1.019	.999	1 1/4	6F	.3750	9/16	13/16	1/4	11/16	8-32(2)
SAV-16XL037-1A X 3/8	16	1.019	.999	1 1/4	6F	.3750	9/16	13/16	1/4	11/16	8-32(2)
17XL037-1A X 1/4	17	1.082	1.062	1 5/16	6F	.2500	9/16	13/16	1/4	3/4	8-32(2)
SAV-17XL037-1A X 1/4	17	1.082	1.062	1 5/16	6F	.2500	9/16	13/16	1/4	3/4	8-32(2)
18XL037-1A X 1/4	18	1.146	1.126	1 3/8	6F	.2500	9/16	13/16	1/4	13/16	8-32(2)
SAV-18XL037-1A X 1/4	18	1.146	1.126	1 3/8	6F	.2500	9/16	13/16	1/4	13/16	8-32(2)
18XL037-1A X 5/16	18	1.146	1.126	1 3/8	6F	.3125	9/16	13/16	1/4	13/16	8-32(2)
SAV-18XL037-1A X 5/16	18	1.146	1.126	1 3/8	6F	.3125	9/16	13/16	1/4	13/16	8-32(2)
18XL037-1A X 3/8	18	1.146	1.126	1 3/8	6F	.3750	9/16	13/16	1/4	13/16	8-32(2)
SAV-18XL037-1A X 3/8	18	1.146	1.126	1 3/8	6F	.3750	9/16	13/16	1/4	13/16	8-32(2)
18XL037-1A X 1/2	18	1.146	1.126	1 3/8	6F	.5000	9/16	13/16	1/4	13/16	8-32(2)
SAV-18XL037-1A X 1/2	18	1.146	1.126	1 3/8	6F	.5000	9/16	13/16	1/4	13/16	8-32(2)
19XL037-1A X 1/4	19	1.210	1.190	1 7/16	6F	.2500	9/16	13/16	1/4	7/8	8-32(2)
SAV-19XL037-1A X 1/4	19	1.210	1.190	1 7/16	6F	.2500	9/16	13/16	1/4	7/8	8-32(2)
20XL037-1A X 1/4	20	1.273	1.253	1 1/2	6F	.2500	9/16	7/8	5/16	15/16	8-32(2)
SAV-20XL037-1A X 1/4	20	1.273	1.253	1 1/2	6F	.2500	9/16	7/8	5/16	15/16	8-32(2)
20XL037-1A X 5/16	20	1.273	1.253	1 1/2	6F	.3125	9/16	7/8	5/16	15/16	8-32(2)
SAV-20XL037-1A X 5/16	20	1.273	1.253	1 1/2	6F	.3125	9/16	7/8	5/16	15/16	8-32(2)
20XL037-1A X 3/8	20	1.273	1.253	1 1/2	6F	.3750	9/16	7/8	5/16	15/16	10-32(2)
SAV-20XL037-1A X 3/8	20	1.273	1.253	1 1/2	6F	.3750	9/16	7/8	5/16	15/16	10-32(2)
20XL037-1A X 1/2	20	1.273	1.253	1 1/2	6F	.5000	9/16	7/8	5/16	15/16	10-32(2)
SAV-20XL037-1A X 1/2	20	1.273	1.253	1 1/2	6F	.5000	9/16	7/8	5/16	15/16	10-32(2)
21XL037-1A X 1/4	21	1.337	1.317	1 9/16	6F	.2500	9/16	7/8	5/16	1	8-32(2)
SAV-21XL037-1A X 1/4	21	1.337	1.317	1 9/16	6F	.2500	9/16	7/8	5/16	1	8-32(2)
21XL037-1A X 5/16	21	1.337	1.317	1 9/16	6F	.3125	9/16	7/8	5/16	1	8-32(2)
SAV-21XL037-1A X 5/16	21	1.337	1.317	1 9/16	6F	.3125	9/16	7/8	5/16	1	8-32(2)
21XL037-1A X 3/8	21	1.337	1.317	1 9/16	6F	.3750	9/16	7/8	5/16	1	10-32(2)
SAV-21XL037-1A X 3/8	21	1.337	1.317	1 9/16	6F	.3750	9/16	7/8	5/16	1	10-32(2)
22XL037-1A X 1/4	22	1.401	1.381	1 5/8	6F	.2500	9/16	7/8	5/16	1	8-32(2)
SAV-22XL037-1A X 1/4	22	1.401	1.381	1 5/8	6F	.2500	9/16	7/8	5/16	1	8-32(2)

"SAV-" in front of any standard timing pulley part # represents the Shaft-Saver version. Shaft-Saver pulleys have special setscrews that grip without damage to the shaft and allow easy pulley removal and realignment. For additional information, see our Shaft-Saver Engineering Section.

ALUMINUM WITH CLEAR ANODIZE (RoHS compliant)

FOR BELTS UP TO 3/8" WIDE

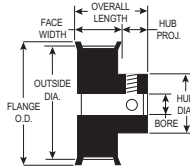

TYPE 6F



PART NUMBER	NO.OF GROOVES	PITCH DIA.	OUTSIDE DIA.	FLANGE O.D.	TYPE	BORE (+.001 / -.000)	FACE WIDTH	OVERALL LENGTH	HUB PROJ.	HUB DIA.	SET SCREWS
22XL037-1A X 5/16	22	1.401	1.381	1 5/8	6F	.3125	9/16	7/8	5/16	1	8-32(2)
SAV-22XL037-1A X 5/16	22	1.401	1.381	1 5/8	6F	.3125	9/16	7/8	5/16	1	8-32(2)
22XL037-1A X 3/8	22	1.401	1.381	1 5/8	6F	.3750	9/16	7/8	5/16	1	10-32(2)
SAV-22XL037-1A X 3/8	22	1.401	1.381	1 5/8	6F	.3750	9/16	7/8	5/16	1	10-32(2)
23XL037-1A X 1/4	23	1.464	1.444	1 11/16	6F	.2500	9/16	7/8	5/16	1 1/16	8-32(2)
SAV-23XL037-1A X 1/4	23	1.464	1.444	1 11/16	6F	.2500	9/16	7/8	5/16	1 1/16	8-32(2)
24XL037-1A X 1/4	24	1.528	1.508	1 3/4	6F	.2500	9/16	29/32	11/32	1 1/16	8-32(2)
SAV-24XL037-1A X 1/4	24	1.528	1.508	1 3/4	6F	.2500	9/16	29/32	11/32	1 1/16	8-32(2)
24XL037-1A X 5/16	24	1.528	1.508	1 3/4	6F	.3125	9/16	29/32	11/32	1 1/16	8-32(2)
SAV-24XL037-1A X 5/16	24	1.528	1.508	1 3/4	6F	.3125	9/16	29/32	11/32	1 1/16	8-32(2)
24XL037-1A X 3/8	24	1.528	1.508	1 3/4	6F	.3750	9/16	29/32	11/32	1 1/16	10-32(2)
SAV-24XL037-1A X 3/8	24	1.528	1.508	1 3/4	6F	.3750	9/16	29/32	11/32	1 1/16	10-32(2)
24XL037-1A X 1/2	24	1.528	1.508	1 3/4	6F	.5000	9/16	29/32	11/32	1 1/16	10-32(2)
SAV-24XL037-1A X 1/2	24	1.528	1.508	1 3/4	6F	.5000	9/16	29/32	11/32	1 1/16	10-32(2)
25XL037-1A X 1/4	25	1.592	1.572	1 13/16	6F	.2500	9/16	29/32	11/32	1 3/32	8-32(2)
SAV-25XL037-1A X 1/4	25	1.592	1.572	1 13/16	6F	.2500	9/16	29/32	11/32	1 3/32	8-32(2)
25XL037-1A X 3/8	25	1.592	1.572	1 13/16	6F	.3750	9/16	29/32	11/32	1 3/32	10-32(2)
SAV-25XL037-1A X 3/8	25	1.592	1.572	1 13/16	6F	.3750	9/16	29/32	11/32	1 3/32	10-32(2)
26XL037-1A X 1/4	26	1.655	1.635	1 7/8	6F	.2500	9/16	29/32	11/32	1 3/16	8-32(2)
SAV-26XL037-1A X 1/4	26	1.655	1.635	1 7/8	6F	.2500	9/16	29/32	11/32	1 3/16	8-32(2)
26XL037-1A X 3/8	26	1.655	1.635	1 7/8	6F	.3750	9/16	29/32	11/32	1 3/16	10-32(2)
SAV-26XL037-1A X 3/8	26	1.655	1.635	1 7/8	6F	.3750	9/16	29/32	11/32	1 3/16	10-32(2)
28XL037-1A X 1/4	28	1.783	1.763	2	6F	.2500	9/16	29/32	11/32	1 3/16	8-32(2)
SAV-28XL037-1A X 1/4	28	1.783	1.763	2	6F	.2500	9/16	29/32	11/32	1 3/16	8-32(2)
28XL037-1A X 5/16	28	1.783	1.763	2	6F	.3125	9/16	29/32	11/32	1 3/16	8-32(2)
SAV-28XL037-1A X 5/16	28	1.783	1.763	2	6F	.3125	9/16	29/32	11/32	1 3/16	8-32(2)
28XL037-1A X 3/8	28	1.783	1.763	2	6F	.3750	9/16	29/32	11/32	1 3/16	10-32(2)
SAV-28XL037-1A X 3/8	28	1.783	1.763	2	6F	.3750	9/16	29/32	11/32	1 3/16	10-32(2)
30XL037-1A X 1/4	30	1.910	1.890	2 1/8	6F	.2500	9/16	29/32	11/32	1 5/16	8-32(2)
SAV-30XL037-1A X 1/4	30	1.910	1.890	2 1/8	6F	.2500	9/16	29/32	11/32	1 5/16	8-32(2)

“SAV.” in front of any standard timing pulley part # represents the Shaft-Saver version. Shaft-Saver pulleys have special setscrews that grip without damage to the shaft and allow easy pulley removal and realignment. For additional information, see our Shaft-Saver Engineering Section.

York also manufactures custom pulleys and complete assemblies
 email:support@york-ind.com web: www.york-ind.com



ALUMINUM WITH CLEAR ANODIZE (RoHS compliant)

FOR BELTS UP TO 3/8" WIDE

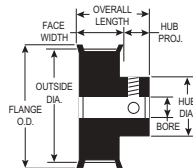

TYPE 6F

PART NUMBER	NO. OF GROOVES	PITCH DIA.	OUTSIDE DIA.	FLANGE O.D.	TYPE	BORE (+.001 / -.000)	FACE WIDTH	OVERALL LENGTH	HUB PROJ.	HUB DIA.	SET SCREWS
30XL037-1A X 5/16	30	1.910	1.890	2 1/8	6F	.3125	9/16	29/32	11/32	1 5/16	8-32(2)
SAV-30XL037-1A X 5/16	30	1.910	1.890	2 1/8	6F	.3125	9/16	29/32	11/32	1 5/16	8-32(2)
30XL037-1A X 3/8	30	1.910	1.890	2 1/8	6F	.3750	9/16	29/32	11/32	1 5/16	10-32(2)
SAV-30XL037-1A X 3/8	30	1.910	1.890	2 1/8	6F	.3750	9/16	29/32	11/32	1 5/16	10-32(2)
30XL037-1A X 1/2	30	1.910	1.890	2 1/8	6F	.5000	9/16	29/32	11/32	1 5/16	10-32(2)
SAV-30XL037-1A X 1/2	30	1.910	1.890	2 1/8	6F	.5000	9/16	29/32	11/32	1 5/16	10-32(2)
32XL037-1A X 5/16	32	2.037	2.017	2 1/4	6F	.3125	9/16	29/32	11/32	1 7/16	8-32(2)
SAV-32XL037-1A X 5/16	32	2.037	2.017	2 1/4	6F	.3125	9/16	29/32	11/32	1 7/16	8-32(2)
32XL037-1A X 3/8	32	2.037	2.017	2 1/4	6F	.3750	9/16	29/32	11/32	1 7/16	10-32(2)
SAV-32XL037-1A X 3/8	32	2.037	2.017	2 1/4	6F	.3750	9/16	29/32	11/32	1 7/16	10-32(2)

"SAV-" in front of any standard timing pulley part # represents the Shaft-Saver version. Shaft-Saver pulleys have special setscrews that grip without damage to the shaft and allow easy pulley removal and realignment. For additional information, see our Shaft-Saver Engineering Section.

ALUMINUM (RoHS compliant)

FOR BELTS UP TO 3/8" WIDE

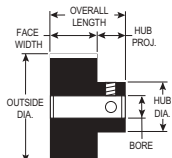

TYPE 6



PART NUMBER	NO. OF GROOVES	PITCH DIA.	OUTSIDE DIA.	TYPE	ANODIZE	BORE (+.001 / -.000)	FACE WIDTH	OVERALL LENGTH	HUB PROJ.	HUB DIA.	SET SCREWS
10XL037-2A X 3/16	10	.637	.617	6	CLEAR	.1875	9/16	13/16	1/4	7/16	6-40(1)
SAV-10XL037-2A X 3/16	10	.637	.617	6	CLEAR	.1875	9/16	13/16	1/4	7/16	6-40(1)
10XL037-2A X 1/4	10	.637	.617	6	CLEAR	.2500	9/16	13/16	1/4	7/16	8-32(1)
SAV-10XL037-2A X 1/4	10	.637	.617	6	CLEAR	.2500	9/16	13/16	1/4	7/16	8-32(1)
11XL037-2A X 3/16	11	.700	.680	6	CLEAR	.1875	9/16	13/16	1/4	1/2	6-40(1)
SAV-11XL037-2A X 3/16	11	.700	.680	6	CLEAR	.1875	9/16	13/16	1/4	1/2	6-40(1)
11XL037-2A X 1/4	11	.700	.680	6	CLEAR	.2500	9/16	13/16	1/4	1/2	8-32(1)
SAV-11XL037-2A X 1/4	11	.700	.680	6	CLEAR	.2500	9/16	13/16	1/4	1/2	8-32(1)
12XL037-2A X 3/16	12	.764	.744	6	CLEAR	.1875	9/16	13/16	1/4	9/16	6-40(2)
SAV-12XL037-2A X 3/16	12	.764	.744	6	CLEAR	.1875	9/16	13/16	1/4	9/16	6-40(2)
12XL037-2A X 1/4	12	.764	.744	6	CLEAR	.2500	9/16	13/16	1/4	9/16	8-32(2)
SAV-12XL037-2A X 1/4	12	.764	.744	6	CLEAR	.2500	9/16	13/16	1/4	9/16	8-32(2)
14XL037-2A X 1/4	14	.891	.871	6	CLEAR	.2500	9/16	13/16	1/4	5/8	8-32(2)
SAV-14XL037-2A X 1/4	14	.891	.871	6	CLEAR	.2500	9/16	13/16	1/4	5/8	8-32(2)
14XL037-2A X 5/16	14	.891	.871	6	CLEAR	.3125	9/16	13/16	1/4	5/8	8-32(2)
SAV-14XL037-2A X 5/16	14	.891	.871	6	CLEAR	.3125	9/16	13/16	1/4	5/8	8-32(2)
15XL037-2A X 1/4	15	.955	.935	6	CLEAR	.2500	9/16	7/8	5/16	11/16	8-32(2)
SAV-15XL037-2A X 1/4	15	.955	.935	6	CLEAR	.2500	9/16	7/8	5/16	11/16	8-32(2)
15XL037-2A X 5/16	15	.955	.935	6	CLEAR	.3125	9/16	7/8	5/16	11/16	8-32(2)
SAV-15XL037-2A X 5/16	15	.955	.935	6	CLEAR	.3125	9/16	7/8	5/16	11/16	8-32(2)
15XL037-2A X 3/8	15	.955	.935	6	CLEAR	.3750	9/16	7/8	5/16	11/16	8-32(2)
SAV-15XL037-2A X 3/8	15	.955	.935	6	CLEAR	.3750	9/16	7/8	5/16	11/16	8-32(2)
16XL037-2A X 1/4	16	1.019	.999	6	CLEAR	.2500	9/16	7/8	5/16	3/4	8-32(2)
SAV-16XL037-2A X 1/4	16	1.019	.999	6	CLEAR	.2500	9/16	7/8	5/16	3/4	8-32(2)
16XL037-2A X 5/16	16	1.019	.999	6	CLEAR	.3125	9/16	7/8	5/16	3/4	8-32(2)
SAV-16XL037-2A X 5/16	16	1.019	.999	6	CLEAR	.3125	9/16	7/8	5/16	3/4	8-32(2)
17XL037-2A X 1/4	17	1.082	1.062	6	CLEAR	.2500	9/16	7/8	5/16	13/16	8-32(2)
SAV-17XL037-2A X 1/4	17	1.082	1.062	6	CLEAR	.2500	9/16	7/8	5/16	13/16	8-32(2)
18XL037-2A X 1/4	18	1.146	1.126	6	CLEAR	.2500	9/16	7/8	5/16	7/8	8-32(2)
SAV-18XL037-2A X 1/4	18	1.146	1.126	6	CLEAR	.2500	9/16	7/8	5/16	7/8	8-32(2)
18XL037-2A X 5/16	18	1.146	1.126	6	CLEAR	.3125	9/16	7/8	5/16	7/8	8-32(2)
SAV-18XL037-2A X 5/16	18	1.146	1.126	6	CLEAR	.3125	9/16	7/8	5/16	7/8	8-32(2)

"SAV." in front of any standard timing pulley part # represents the Shaft-Saver version. Shaft-Saver pulleys have special setscrews that grip without damage to the shaft and allow easy pulley removal and realignment. For additional information, see our Shaft-Saver Engineering Section.

York also manufactures custom pulleys and complete assemblies
 email:support@york-ind.com web: www.york-ind.com



ALUMINUM (RoHS compliant)

FOR BELTS UP TO 3/8" WIDE

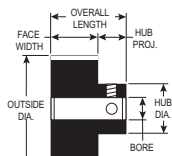

TYPE 6

PART NUMBER	NO. OF GROOVES	PITCH DIA.	OUTSIDE DIA.	TYPE	ANODIZE	BORE (+.001) (-.000)	FACE WIDTH	OVERALL LENGTH	HUB PROJ.	HUB DIA.	SET SCREWS
18XL037-2A X 3/8	18	1.146	1.126	6	CLEAR	.3750	9/16	7/8	5/16	7/8	8-32(2)
SAV-18XL037-2A X 3/8	18	1.146	1.126	6	CLEAR	.3750	9/16	7/8	5/16	7/8	8-32(2)
19XL037-2A X 1/4	19	1.210	1.190	6	CLEAR	.2500	9/16	7/8	5/16	7/8	8-32(2)
SAV-19XL037-2A X 1/4	19	1.210	1.190	6	CLEAR	.2500	9/16	7/8	5/16	7/8	8-32(2)
20XL037-2A X 1/4	20	1.273	1.253	6	CLEAR	.2500	9/16	15/16	3/8	15/16	8-32(2)
SAV-20XL037-2A X 1/4	20	1.273	1.253	6	CLEAR	.2500	9/16	15/16	3/8	15/16	8-32(2)
20XL037-2A X 5/16	20	1.273	1.253	6	CLEAR	.3125	9/16	15/16	3/8	15/16	8-32(2)
SAV-20XL037-2A X 5/16	20	1.273	1.253	6	CLEAR	.3125	9/16	15/16	3/8	15/16	8-32(2)
20XL037-2A X 3/8	20	1.273	1.253	6	CLEAR	.3750	9/16	15/16	3/8	15/16	10-32(2)
SAV-20XL037-2A X 3/8	20	1.273	1.253	6	CLEAR	.3750	9/16	15/16	3/8	15/16	10-32(2)
21XL037-2A X 1/4	21	1.337	1.317	6	CLEAR	.2500	9/16	15/16	3/8	1	8-32(2)
SAV-21XL037-2A X 1/4	21	1.337	1.317	6	CLEAR	.2500	9/16	15/16	3/8	1	8-32(2)
21XL037-2A X 5/16	21	1.337	1.317	6	CLEAR	.3125	9/16	15/16	3/8	1	8-32(2)
SAV-21XL037-2A X 5/16	21	1.337	1.317	6	CLEAR	.3125	9/16	15/16	3/8	1	8-32(2)
22XL037-2A X 1/4	22	1.401	1.381	6	CLEAR	.2500	9/16	15/16	3/8	1 1/16	8-32(2)
SAV-22XL037-2A X 1/4	22	1.401	1.381	6	CLEAR	.2500	9/16	15/16	3/8	1 1/16	8-32(2)
22XL037-2A X 5/16	22	1.401	1.381	6	CLEAR	.3125	9/16	15/16	3/8	1 1/16	8-32(2)
SAV-22XL037-2A X 5/16	22	1.401	1.381	6	CLEAR	.3125	9/16	15/16	3/8	1 1/16	8-32(2)
22XL037-2A X 3/8	22	1.401	1.381	6	CLEAR	.3750	9/16	15/16	3/8	1 1/16	10-32(2)
SAV-22XL037-2A X 3/8	22	1.401	1.381	6	CLEAR	.3750	9/16	15/16	3/8	1 1/16	10-32(2)
23XL037-2A X 1/4	23	1.464	1.444	6	CLEAR	.2500	9/16	15/16	3/8	1 1/8	8-32(2)
SAV-23XL037-2A X 1/4	23	1.464	1.444	6	CLEAR	.2500	9/16	15/16	3/8	1 1/8	8-32(2)
24XL037-2A X 1/4	24	1.528	1.508	6	CLEAR	.2500	9/16	15/16	3/8	1 3/16	8-32(2)
SAV-24XL037-2A X 1/4	24	1.528	1.508	6	CLEAR	.2500	9/16	15/16	3/8	1 3/16	8-32(2)
24XL037-2A X 5/16	24	1.528	1.508	6	CLEAR	.3125	9/16	15/16	3/8	1 3/16	8-32(2)
SAV-24XL037-2A X 5/16	24	1.528	1.508	6	CLEAR	.3125	9/16	15/16	3/8	1 3/16	8-32(2)
24XL037-2A X 3/8	24	1.528	1.508	6	CLEAR	.3750	9/16	15/16	3/8	1 3/16	10-32(2)
SAV-24XL037-2A X 3/8	24	1.528	1.508	6	CLEAR	.3750	9/16	15/16	3/8	1 3/16	10-32(2)
25XL037-2A X 1/4	25	1.592	1.572	6	CLEAR	.2500	9/16	15/16	3/8	1 1/4	8-32(2)
SAV-25XL037-2A X 1/4	25	1.592	1.572	6	CLEAR	.2500	9/16	15/16	3/8	1 1/4	8-32(2)
25XL037-2A X 3/8	25	1.592	1.572	6	CLEAR	.3750	9/16	15/16	3/8	1 1/4	10-32(2)
SAV-25XL037-2A X 3/8	25	1.592	1.572	6	CLEAR	.3750	9/16	15/16	3/8	1 1/4	10-32(2)

"SAV-" in front of any standard timing pulley part # represents the Shaft-Saver version. Shaft-Saver pulleys have special setscrews that grip without damage to the shaft and allow easy pulley removal and realignment. For additional information, see our Shaft-Saver Engineering Section.

ALUMINUM (RoHS compliant)

FOR BELTS UP TO 3/8" WIDE

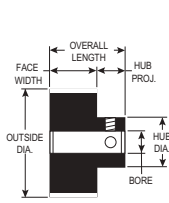

TYPE 6

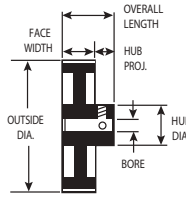

TYPE 6W



PART NUMBER	NO. OF GROOVES	PITCH DIA.	OUTSIDE DIA.	TYPE	ANODIZE	BORE (+.001 / -.000)	FACE WIDTH	OVERALL LENGTH	HUB PROJ.	HUB DIA.	SET SCREWS
27XL037-2A X 5/16	27	1.719	1.699	6	CLEAR	.3125	9/16	15/16	3/8	1 1/4	8-32(2)
SAV-27XL037-2A X 5/16	27	1.719	1.699	6	CLEAR	.3125	9/16	15/16	3/8	1 1/4	8-32(2)
28XL037-2A X 1/4	28	1.783	1.763	6	CLEAR	.2500	9/16	15/16	3/8	1 1/4	8-32(2)
SAV-28XL037-2A X 1/4	28	1.783	1.763	6	CLEAR	.2500	9/16	15/16	3/8	1 1/4	8-32(2)
28XL037-2A X 5/16	28	1.783	1.763	6	CLEAR	.3125	9/16	15/16	3/8	1 1/4	8-32(2)
SAV-28XL037-2A X 5/16	28	1.783	1.763	6	CLEAR	.3125	9/16	15/16	3/8	1 1/4	8-32(2)
28XL037-2A X 3/8	28	1.783	1.763	6	CLEAR	.3750	9/16	15/16	3/8	1 1/4	10-32(2)
SAV-28XL037-2A X 3/8	28	1.783	1.763	6	CLEAR	.3750	9/16	15/16	3/8	1 1/4	10-32(2)
29XL037-2A X 5/16	29	1.846	1.826	6	CLEAR	.3125	9/16	15/16	3/8	1 5/16	8-32(2)
SAV-29XL037-2A X 5/16	29	1.846	1.826	6	CLEAR	.3125	9/16	15/16	3/8	1 5/16	8-32(2)
30XL037-2A X 1/4	30	1.910	1.890	6	CLEAR	.2500	9/16	15/16	3/8	1 3/8	8-32(2)
SAV-30XL037-2A X 1/4	30	1.910	1.890	6	CLEAR	.2500	9/16	15/16	3/8	1 3/8	8-32(2)
30XL037-2A X 5/16	30	1.910	1.890	6	CLEAR	.3125	9/16	15/16	3/8	1 3/8	8-32(2)
SAV-30XL037-2A X 5/16	30	1.910	1.890	6	CLEAR	.3125	9/16	15/16	3/8	1 3/8	8-32(2)
30XL037-2A X 3/8	30	1.910	1.890	6	CLEAR	.3750	9/16	15/16	3/8	1 3/8	10-32(2)
SAV-30XL037-2A X 3/8	30	1.910	1.890	6	CLEAR	.3750	9/16	15/16	3/8	1 3/8	10-32(2)
32XL037-2A X 5/16	32	2.037	2.017	6	CLEAR	.3125	9/16	1	7/16	1 1/2	8-32(2)
SAV-32XL037-2A X 5/16	32	2.037	2.017	6	CLEAR	.3125	9/16	1	7/16	1 1/2	8-32(2)
32XL037-2A X 3/8	32	2.037	2.017	6	CLEAR	.3750	9/16	1	7/16	1 1/2	10-32(2)
SAV-32XL037-2A X 3/8	32	2.037	2.017	6	CLEAR	.3750	9/16	1	7/16	1 1/2	10-32(2)
32XL037-2A X 1/2	32	2.037	2.017	6	CLEAR	.5000	9/16	1	7/16	1 1/2	1/4-20(2)
SAV-32XL037-2A X 1/2	32	2.037	2.017	6	CLEAR	.5000	9/16	1	7/16	1 1/2	1/4-20(2)
36XL037-2A X 5/16	36	2.292	2.272	6	CLEAR	.3125	9/16	1	7/16	1 1/2	8-32(2)
SAV-36XL037-2A X 5/16	36	2.292	2.272	6	CLEAR	.3125	9/16	1	7/16	1 1/2	8-32(2)
36XL037-2A X 3/8	36	2.292	2.272	6	CLEAR	.3750	9/16	1	7/16	1 1/2	10-32(2)
SAV-36XL037-2A X 3/8	36	2.292	2.272	6	CLEAR	.3750	9/16	1	7/16	1 1/2	10-32(2)
36XL037-2A X 1/2	36	2.292	2.272	6	CLEAR	.5000	9/16	1	7/16	1 1/2	1/4-20(2)
SAV-36XL037-2A X 1/2	36	2.292	2.272	6	CLEAR	.5000	9/16	1	7/16	1 1/2	1/4-20(2)
40XL037-3A X 5/16	40	2.546	2.526	6W	NONE	.3125	9/16	1	7/16	1 1/2	8-32(2)
SAV-40XL037-3A X 5/16	40	2.546	2.526	6W	NONE	.3125	9/16	1	7/16	1 1/2	8-32(2)

"SAV-" in front of any standard timing pulley part # represents the Shaft-Saver version. Shaft-Saver pulleys have special setscrews that grip without damage to the shaft and allow easy pulley removal and realignment. For additional information, see our Shaft-Saver Engineering Section.

York also manufactures custom pulleys and complete assemblies
 email:support@york-ind.com web: www.york-ind.com



ALUMINUM (RoHS compliant)

FOR BELTS UP TO 3/8" WIDE

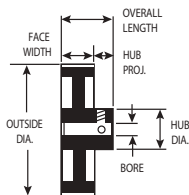

TYPE 6W

PART NUMBER	NO. OF GROOVES	PITCH DIA.	OUTSIDE DIA.	TYPE	ANODIZE	BORE (+.001) (-.000)	FACE WIDTH	OVERALL LENGTH	HUB PROJ.	HUB DIA.	SET SCREWS
40XL037-3A X 3/8	40	2.546	2.526	6W	NONE	.3750	9/16	1	7/16	1 1/2	10-32(2)
SAV-40XL037-3A X 3/8	40	2.546	2.526	6W	NONE	.3750	9/16	1	7/16	1 1/2	10-32(2)
40XL037-3A X 1/2	40	2.546	2.526	6W	NONE	.5000	9/16	1	7/16	1 1/2	1/4-20(2)
SAV-40XL037-3A X 1/2	40	2.546	2.526	6W	NONE	.5000	9/16	1	7/16	1 1/2	1/4-20(2)
42XL037-3A X 5/16	42	2.674	2.654	6W	NONE	.3125	9/16	1	7/16	1 1/2	8-32(2)
SAV-42XL037-3A X 5/16	42	2.674	2.654	6W	NONE	.3125	9/16	1	7/16	1 1/2	8-32(2)
42XL037-3A X 3/8	42	2.674	2.654	6W	NONE	.3750	9/16	1	7/16	1 1/2	10-32(2)
SAV-42XL037-3A X 3/8	42	2.674	2.654	6W	NONE	.3750	9/16	1	7/16	1 1/2	10-32(2)
42XL037-3A X 1/2	42	2.674	2.654	6W	NONE	.5000	9/16	1	7/16	1 1/2	1/4-20(2)
SAV-42XL037-3A X 1/2	42	2.674	2.654	6W	NONE	.5000	9/16	1	7/16	1 1/2	1/4-20(2)
44XL037-3A X 5/16	44	2.801	2.781	6W	NONE	.3125	9/16	1	7/16	1 1/2	8-32(2)
SAV-44XL037-3A X 5/16	44	2.801	2.781	6W	NONE	.3125	9/16	1	7/16	1 1/2	8-32(2)
44XL037-3A X 3/8	44	2.801	2.781	6W	NONE	.3750	9/16	1	7/16	1 1/2	10-32(2)
SAV-44XL037-3A X 3/8	44	2.801	2.781	6W	NONE	.3750	9/16	1	7/16	1 1/2	10-32(2)
44XL037-3A X 1/2	44	2.801	2.781	6W	NONE	.5000	9/16	1	7/16	1 1/2	1/4-20(2)
SAV-44XL037-3A X 1/2	44	2.801	2.781	6W	NONE	.5000	9/16	1	7/16	1 1/2	1/4-20(2)
45XL037-3A X 5/16	45	2.865	2.845	6W	NONE	.3125	9/16	1	7/16	1 1/2	8-32(2)
SAV-45XL037-3A X 5/16	45	2.865	2.845	6W	NONE	.3125	9/16	1	7/16	1 1/2	8-32(2)
45XL037-3A X 3/8	45	2.865	2.845	6W	NONE	.3750	9/16	1	7/16	1 1/2	10-32(2)
SAV-45XL037-3A X 3/8	45	2.865	2.845	6W	NONE	.3750	9/16	1	7/16	1 1/2	10-32(2)
45XL037-3A X 1/2	45	2.865	2.845	6W	NONE	.5000	9/16	1	7/16	1 1/2	1/4-20(2)
SAV-45XL037-3A X 1/2	45	2.865	2.845	6W	NONE	.5000	9/16	1	7/16	1 1/2	1/4-20(2)
48XL037-3A X 5/16	48	3.056	3.036	6W	NONE	.3125	9/16	1	7/16	1 1/2	8-32(2)
SAV-48XL037-3A X 5/16	48	3.056	3.036	6W	NONE	.3125	9/16	1	7/16	1 1/2	8-32(2)
48XL037-3A X 3/8	48	3.056	3.036	6W	NONE	.3750	9/16	1	7/16	1 1/2	10-32(2)
SAV-48XL037-3A X 3/8	48	3.056	3.036	6W	NONE	.3750	9/16	1	7/16	1 1/2	10-32(2)
48XL037-3A X 1/2	48	3.056	3.036	6W	NONE	.5000	9/16	1	7/16	1 1/2	1/4-20(2)
SAV-48XL037-3A X 1/2	48	3.056	3.036	6W	NONE	.5000	9/16	1	7/16	1 1/2	1/4-20(2)
50XL037-3A X 5/16	50	3.183	3.163	6W	NONE	.3125	9/16	1	7/16	1 1/2	8-32(2)
SAV-50XL037-3A X 5/16	50	3.183	3.163	6W	NONE	.3125	9/16	1	7/16	1 1/2	8-32(2)
50XL037-3A X 3/8	50	3.183	3.163	6W	NONE	.3750	9/16	1	7/16	1 1/2	10-32(2)
SAV-50XL037-3A X 3/8	50	3.183	3.163	6W	NONE	.3750	9/16	1	7/16	1 1/2	10-32(2)

"SAV." in front of any standard timing pulley part # represents the Shaft-Saver version. Shaft-Saver pulleys have special setscrews that grip without damage to the shaft and allow easy pulley removal and realignment. For additional information, see our Shaft-Saver Engineering Section.

ALUMINUM (RoHS compliant)

FOR BELTS UP TO 3/8" WIDE

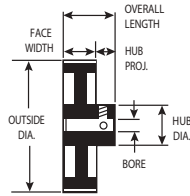

TYPE 6W



PART NUMBER	NO. OF GROOVES	PITCH DIA.	OUTSIDE DIA.	TYPE	ANODIZE	BORE (+.001 / -.000)	FACE WIDTH	OVERALL LENGTH	HUB PROJ.	HUB DIA.	SET SCREWS
50XL037-3A X 1/2	50	3.183	3.163	6W	NONE	.5000	9/16	1	7/16	1 1/2	1/4-20(2)
SAV-50XL037-3A X 1/2	50	3.183	3.163	6W	NONE	.5000	9/16	1	7/16	1 1/2	1/4-20(2)
60XL037-3A X 3/8	60	3.820	3.800	6W	NONE	.3750	9/16	1	7/16	1 1/2	10-32(2)
SAV-60XL037-3A X 3/8	60	3.820	3.800	6W	NONE	.3750	9/16	1	7/16	1 1/2	10-32(2)
60XL037-3A X 1/2	60	3.820	3.800	6W	NONE	.5000	9/16	1	7/16	1 1/2	1/4-20(2)
SAV-60XL037-3A X 1/2	60	3.820	3.800	6W	NONE	.5000	9/16	1	7/16	1 1/2	1/4-20(2)
72XL037-3A X 3/8	72	4.584	4.564	6W	NONE	.3750	9/16	1	7/16	1 1/2	10-32(2)
SAV-72XL037-3A X 3/8	72	4.584	4.564	6W	NONE	.3750	9/16	1	7/16	1 1/2	10-32(2)
72XL037-3A X 1/2	72	4.584	4.564	6W	NONE	.5000	9/16	1	7/16	1 1/2	1/4-20(2)
SAV-72XL037-3A X 1/2	72	4.584	4.564	6W	NONE	.5000	9/16	1	7/16	1 1/2	1/4-20(2)

“SAV-” in front of any standard timing pulley part # represents the Shaft-Saver version. Shaft-Saver pulleys have special setscrews that grip without damage to the shaft and allow easy pulley removal and realignment. For additional information, see our Shaft-Saver Engineering Section.

York also manufactures custom pulleys and complete assemblies
 email:support@york-ind.com web: www.york-ind.com



STEEL WITH BLACK OXIDE (RoHS compliant)

FOR BELTS UP TO 3/8" WIDE

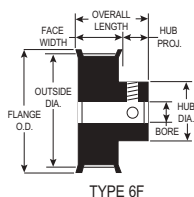

TYPE 6F

PART NUMBER	NO. OF GROOVES	PITCH DIA.	OUTSIDE DIA.	FLANGE O.D.	TYPE	BORE (+.001/-000)	FACE WIDTH	OVERALL LENGTH	HUB PROJ.	HUB DIA.	SET SCREWS
10XL037-1S X 3/16	10	.637	.617	7/8	6F	.1875	9/16	13/16	1/4	7/16	6-40(1)
SAV-10XL037-1S X 3/16	10	.637	.617	7/8	6F	.1875	9/16	13/16	1/4	7/16	6-40(1)
10XL037-1S X 1/4	10	.637	.617	7/8	6F	.2500	9/16	13/16	1/4	7/16	8-32(1)
SAV-10XL037-1S X 1/4	10	.637	.617	7/8	6F	.2500	9/16	13/16	1/4	7/16	8-32(1)
11XL037-1S X 3/16	11	.700	.680	15/16	6F	.1875	9/16	13/16	1/4	1/2	6-40(1)
SAV-11XL037-1S X 3/16	11	.700	.680	15/16	6F	.1875	9/16	13/16	1/4	1/2	6-40(1)
11XL037-1S X 1/4	11	.700	.680	15/16	6F	.2500	9/16	13/16	1/4	1/2	8-32(1)
SAV-11XL037-1S X 1/4	11	.700	.680	15/16	6F	.2500	9/16	13/16	1/4	1/2	8-32(1)
12XL037-1S X 3/16	12	.764	.744	1	6F	.1875	9/16	13/16	1/4	1/2	6-40(2)
SAV-12XL037-1S X 3/16	12	.764	.744	1	6F	.1875	9/16	13/16	1/4	1/2	6-40(2)
12XL037-1S X 1/4	12	.764	.744	1	6F	.2500	9/16	13/16	1/4	1/2	8-32(2)
SAV-12XL037-1S X 1/4	12	.764	.744	1	6F	.2500	9/16	13/16	1/4	1/2	8-32(2)
14XL037-1S X 1/4	14	.891	.871	1 3/32	6F	.2500	9/16	13/16	1/4	9/16	8-32(2)
SAV-14XL037-1S X 1/4	14	.891	.871	1 3/32	6F	.2500	9/16	13/16	1/4	9/16	8-32(2)
14XL037-1S X 5/16	14	.891	.871	1 3/32	6F	.3125	9/16	13/16	1/4	9/16	8-32(2)
SAV-14XL037-1S X 5/16	14	.891	.871	1 3/32	6F	.3125	9/16	13/16	1/4	9/16	8-32(2)
15XL037-1S X 1/4	15	.955	.935	1 3/16	6F	.2500	9/16	13/16	1/4	5/8	8-32(2)
SAV-15XL037-1S X 1/4	15	.955	.935	1 3/16	6F	.2500	9/16	13/16	1/4	5/8	8-32(2)
15XL037-1S X 5/16	15	.955	.935	1 3/16	6F	.3125	9/16	13/16	1/4	5/8	8-32(2)
SAV-15XL037-1S X 5/16	15	.955	.935	1 3/16	6F	.3125	9/16	13/16	1/4	5/8	8-32(2)
15XL037-1S X 3/8	15	.955	.935	1 3/16	6F	.3750	9/16	13/16	1/4	5/8	8-32(2)
SAV-15XL037-1S X 3/8	15	.955	.935	1 3/16	6F	.3750	9/16	13/16	1/4	5/8	8-32(2)
15XL037-1S X 1/2	15	.955	.935	1 3/16	6F	.5000	9/16	13/16	1/4	5/8	8-32(2)
SAV-15XL037-1S X 1/2	15	.955	.935	1 3/16	6F	.5000	9/16	13/16	1/4	5/8	8-32(2)
16XL037-1S X 1/4	16	1.019	.999	1 1/4	6F	.2500	9/16	13/16	1/4	11/16	8-32(2)
SAV-16XL037-1S X 1/4	16	1.019	.999	1 1/4	6F	.2500	9/16	13/16	1/4	11/16	8-32(2)
16XL037-1S X 5/16	16	1.019	.999	1 1/4	6F	.3125	9/16	13/16	1/4	11/16	8-32(2)
SAV-16XL037-1S X 5/16	16	1.019	.999	1 1/4	6F	.3125	9/16	13/16	1/4	11/16	8-32(2)
18XL037-1S X 1/4	18	1.146	1.126	1 3/8	6F	.2500	9/16	13/16	1/4	13/16	8-32(2)
SAV-18XL037-1S X 1/4	18	1.146	1.126	1 3/8	6F	.2500	9/16	13/16	1/4	13/16	8-32(2)

"SAV-" in front of any standard timing pulley part # represents the Shaft-Saver version. Shaft-Saver pulleys have special setscrews that grip without damage to the shaft and allow easy pulley removal and realignment. For additional information, see our Shaft-Saver Engineering Section.

STEEL WITH BLACK OXIDE (RoHS compliant)

FOR BELTS UP TO 3/8" WIDE

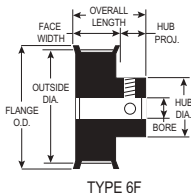

PART NUMBER	NO. OF GROOVES	PITCH DIA.	OUTSIDE DIA.	FLANGE O.D.	TYPE	BORE (+.001 (-.000))	FACE WIDTH	OVERALL LENGTH	HUB PROJ.	HUB DIA.	SET SCREWS
18XL037-1S X 5/16	18	1.146	1.126	1 3/8	6F	.3125	9/16	13/16	1/4	13/16	8-32(2)
SAV-18XL037-1S X 5/16	18	1.146	1.126	1 3/8	6F	.3125	9/16	13/16	1/4	13/16	8-32(2)
18XL037-1S X 3/8	18	1.146	1.126	1 3/8	6F	.3750	9/16	13/16	1/4	13/16	8-32(2)
SAV-18XL037-1S X 3/8	18	1.146	1.126	1 3/8	6F	.3750	9/16	13/16	1/4	13/16	8-32(2)
20XL037-1S X 1/4	20	1.273	1.253	1 1/2	6F	.2500	9/16	7/8	5/16	15/16	8-32(2)
SAV-20XL037-1S X 1/4	20	1.273	1.253	1 1/2	6F	.2500	9/16	7/8	5/16	15/16	8-32(2)
20XL037-1S X 5/16	20	1.273	1.253	1 1/2	6F	.3125	9/16	7/8	5/16	15/16	8-32(2)
SAV-20XL037-1S X 5/16	20	1.273	1.253	1 1/2	6F	.3125	9/16	7/8	5/16	15/16	8-32(2)
20XL037-1S X 3/8	20	1.273	1.253	1 1/2	6F	.3750	9/16	7/8	5/16	15/16	10-32(2)
SAV-20XL037-1S X 3/8	20	1.273	1.253	1 1/2	6F	.3750	9/16	7/8	5/16	15/16	10-32(2)
20XL037-1S X 1/2	20	1.273	1.253	1 1/2	6F	.5000	9/16	7/8	5/16	15/16	10-32(2)
SAV-20XL037-1S X 1/2	20	1.273	1.253	1 1/2	6F	.5000	9/16	7/8	5/16	15/16	10-32(2)
21XL037-1S X 1/4	21	1.337	1.317	1 9/16	6F	.2500	9/16	7/8	5/16	1	8-32(2)
SAV-21XL037-1S X 1/4	21	1.337	1.317	1 9/16	6F	.2500	9/16	7/8	5/16	1	8-32(2)
21XL037-1S X 5/16	21	1.337	1.317	1 9/16	6F	.3125	9/16	7/8	5/16	1	8-32(2)
SAV-21XL037-1S X 5/16	21	1.337	1.317	1 9/16	6F	.3125	9/16	7/8	5/16	1	8-32(2)
22XL037-1S X 1/4	22	1.401	1.381	1 5/8	6F	.2500	9/16	7/8	5/16	1	8-32(2)
SAV-22XL037-1S X 1/4	22	1.401	1.381	1 5/8	6F	.2500	9/16	7/8	5/16	1	8-32(2)
22XL037-1S X 5/16	22	1.401	1.381	1 5/8	6F	.3125	9/16	7/8	5/16	1	8-32(2)
SAV-22XL037-1S X 5/16	22	1.401	1.381	1 5/8	6F	.3125	9/16	7/8	5/16	1	8-32(2)
22XL037-1S X 3/8	22	1.401	1.381	1 5/8	6F	.3750	9/16	7/8	5/16	1	10-32(2)
SAV-22XL037-1S X 3/8	22	1.401	1.381	1 5/8	6F	.3750	9/16	7/8	5/16	1	10-32(2)
24XL037-1S X 1/4	24	1.528	1.508	1 3/4	6F	.2500	9/16	29/32	11/32	1 1/16	8-32(2)
SAV-24XL037-1S X 1/4	24	1.528	1.508	1 3/4	6F	.2500	9/16	29/32	11/32	1 1/16	8-32(2)
24XL037-1S X 5/16	24	1.528	1.508	1 3/4	6F	.3125	9/16	29/32	11/32	1 1/16	8-32(2)
SAV-24XL037-1S X 5/16	24	1.528	1.508	1 3/4	6F	.3125	9/16	29/32	11/32	1 1/16	8-32(2)
24XL037-1S X 3/8	24	1.528	1.508	1 3/4	6F	.3750	9/16	29/32	11/32	1 1/16	10-32(2)
SAV-24XL037-1S X 3/8	24	1.528	1.508	1 3/4	6F	.3750	9/16	29/32	11/32	1 1/16	10-32(2)
24XL037-1S X 1/2	24	1.528	1.508	1 3/4	6F	.5000	9/16	29/32	11/32	1 1/16	10-32(2)
SAV-24XL037-1S X 1/2	24	1.528	1.508	1 3/4	6F	.5000	9/16	29/32	11/32	1 1/16	10-32(2)
25XL037-1S X 1/4	25	1.592	1.572	1 13/16	6F	.2500	9/16	29/32	11/32	1 3/32	8-32(2)
SAV-25XL037-1S X 1/4	25	1.592	1.572	1 13/16	6F	.2500	9/16	29/32	11/32	1 3/32	8-32(2)

"SAV-" in front of any standard timing pulley part # represents the Shaft-Saver version. Shaft-Saver pulleys have special setscrews that grip without damage to the shaft and allow easy pulley removal and realignment. For additional information, see our Shaft-Saver Engineering Section.

York also manufactures custom pulleys and complete assemblies
 email:support@york-ind.com web: www.york-ind.com



STEEL WITH BLACK OXIDE (RoHS compliant)

FOR BELTS UP TO 3/8" WIDE

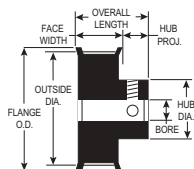

TYPE 6F

PART NUMBER	NO. OF GROOVES	PITCH DIA.	OUTSIDE DIA.	FLANGE O.D.	TYPE	BORE (+.001 / -.000)	FACE WIDTH	OVERALL LENGTH	HUB PROJ.	HUB DIA.	SET SCREWS
25XL037-1S X 3/8	25	1.592	1.572	1 13/16	6F	.3750	9/16	29/32	11/32	1 3/32	10-32(2)
SAV-25XL037-1S X 3/8	25	1.592	1.572	1 13/16	6F	.3750	9/16	29/32	11/32	1 3/32	10-32(2)
28XL037-1S X 1/4	28	1.783	1.763	2	6F	.2500	9/16	29/32	11/32	1 3/16	8-32(2)
SAV-28XL037-1S X 1/4	28	1.783	1.763	2	6F	.2500	9/16	29/32	11/32	1 3/16	8-32(2)
28XL037-1S X 5/16	28	1.783	1.763	2	6F	.3125	9/16	29/32	11/32	1 3/16	8-32(2)
SAV-28XL037-1S X 5/16	28	1.783	1.763	2	6F	.3125	9/16	29/32	11/32	1 3/16	8-32(2)
28XL037-1S X 3/8	28	1.783	1.763	2	6F	.3750	9/16	29/32	11/32	1 3/16	10-32(2)
SAV-28XL037-1S X 3/8	28	1.783	1.763	2	6F	.3750	9/16	29/32	11/32	1 3/16	10-32(2)
30XL037-1S X 1/4	30	1.910	1.890	2 1/8	6F	.2500	9/16	29/32	11/32	1 5/16	8-32(2)
SAV-30XL037-1S X 1/4	30	1.910	1.890	2 1/8	6F	.2500	9/16	29/32	11/32	1 5/16	8-32(2)
30XL037-1S X 5/16	30	1.910	1.890	2 1/8	6F	.3125	9/16	29/32	11/32	1 5/16	8-32(2)
SAV-30XL037-1S X 5/16	30	1.910	1.890	2 1/8	6F	.3125	9/16	29/32	11/32	1 5/16	8-32(2)
30XL037-1S X 3/8	30	1.910	1.890	2 1/8	6F	.3750	9/16	29/32	11/32	1 5/16	10-32(2)
SAV-30XL037-1S X 3/8	30	1.910	1.890	2 1/8	6F	.3750	9/16	29/32	11/32	1 5/16	10-32(2)
30XL037-1S X 1/2	30	1.910	1.890	2 1/8	6F	.5000	9/16	29/32	11/32	1 5/16	10-32(2)
SAV-30XL037-1S X 1/2	30	1.910	1.890	2 1/8	6F	.5000	9/16	29/32	11/32	1 5/16	10-32(2)
32XL037-1S X 5/16	32	2.037	2.017	2 1/4	6F	.3125	9/16	29/32	11/32	1 7/16	8-32(2)
SAV-32XL037-1S X 5/16	32	2.037	2.017	2 1/4	6F	.3125	9/16	29/32	11/32	1 7/16	8-32(2)
32XL037-1S X 3/8	32	2.037	2.017	2 1/4	6F	.3750	9/16	29/32	11/32	1 7/16	10-32(2)
SAV-32XL037-1S X 3/8	32	2.037	2.017	2 1/4	6F	.3750	9/16	29/32	11/32	1 7/16	10-32(2)

"SAV-" in front of any standard timing pulley part # represents the Shaft-Saver version. Shaft-Saver pulleys have special setscrews that grip without damage to the shaft and allow easy pulley removal and realignment. For additional information, see our Shaft-Saver Engineering Section.

ALUMINUM WITH CLEAR ANODIZE (RoHS compliant)

FOR BELTS UP TO 3/8" WIDE

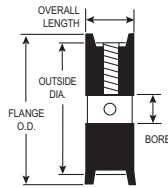

TYPE 3F



PART NUMBER	NO. OF GROOVES	PITCH DIA.	OUTSIDE DIA.	FLANGE O.D.	TYPE	BORE (+.001) (-.000)	FACE WIDTH	OVERALL LENGTH	SET SCREWS
10XL037-5A X 3/16	10	.637	.617	7/8	3F	.1875	9/16	9/16	6-32(1)
SAV-10XL037-5A X 3/16	10	.637	.617	7/8	3F	.1875	9/16	9/16	6-32(1)
10XL037-5A X 1/4	10	.637	.617	7/8	3F	.2500	9/16	9/16	6-32(1)
SAV-10XL037-5A X 1/4	10	.637	.617	7/8	3F	.2500	9/16	9/16	6-32(1)
11XL037-5A X 3/16	11	.700	.680	15/16	3F	.1875	9/16	9/16	6-32(1)
SAV-11XL037-5A X 3/16	11	.700	.680	15/16	3F	.1875	9/16	9/16	6-32(1)
11XL037-5A X 1/4	11	.700	.680	15/16	3F	.2500	9/16	9/16	6-32(1)
SAV-11XL037-5A X 1/4	11	.700	.680	15/16	3F	.2500	9/16	9/16	6-32(1)
12XL037-5A X 3/16	12	.764	.744	1	3F	.1875	9/16	9/16	6-32(1)
SAV-12XL037-5A X 3/16	12	.764	.744	1	3F	.1875	9/16	9/16	6-32(1)
12XL037-5A X 1/4	12	.764	.744	1	3F	.2500	9/16	9/16	8-32(1)
SAV-12XL037-5A X 1/4	12	.764	.744	1	3F	.2500	9/16	9/16	8-32(1)
14XL037-5A X 1/4	14	.891	.871	1 3/32	3F	.2500	9/16	9/16	8-32(2)
SAV-14XL037-5A X 1/4	14	.891	.871	1 3/32	3F	.2500	9/16	9/16	8-32(2)
15XL037-5A X 1/4	15	.955	.935	1 3/16	3F	.2500	9/16	9/16	8-32(2)
SAV-15XL037-5A X 1/4	15	.955	.935	1 3/16	3F	.2500	9/16	9/16	8-32(2)
15XL037-5A X 5/16	15	.955	.935	1 3/16	3F	.3125	9/16	9/16	8-32(2)
SAV-15XL037-5A X 5/16	15	.955	.935	1 3/16	3F	.3125	9/16	9/16	8-32(2)
16XL037-5A X 1/4	16	1.019	.999	1 1/4	3F	.2500	9/16	9/16	8-32(2)
SAV-16XL037-5A X 1/4	16	1.019	.999	1 1/4	3F	.2500	9/16	9/16	8-32(2)
16XL037-5A X 5/16	16	1.019	.999	1 1/4	3F	.3125	9/16	9/16	8-32(2)
SAV-16XL037-5A X 5/16	16	1.019	.999	1 1/4	3F	.3125	9/16	9/16	8-32(2)
18XL037-5A X 1/4	18	1.146	1.126	1 3/8	3F	.2500	9/16	9/16	8-32(2)
SAV-18XL037-5A X 1/4	18	1.146	1.126	1 3/8	3F	.2500	9/16	9/16	8-32(2)
18XL037-5A X 5/16	18	1.146	1.126	1 3/8	3F	.3125	9/16	9/16	8-32(2)
SAV-18XL037-5A X 5/16	18	1.146	1.126	1 3/8	3F	.3125	9/16	9/16	8-32(2)
20XL037-5A X 1/4	20	1.273	1.253	1 1/2	3F	.2500	9/16	9/16	8-32(2)
SAV-20XL037-5A X 1/4	20	1.273	1.253	1 1/2	3F	.2500	9/16	9/16	8-32(2)
20XL037-5A X 5/16	20	1.273	1.253	1 1/2	3F	.3125	9/16	9/16	8-32(2)
SAV-20XL037-5A X 5/16	20	1.273	1.253	1 1/2	3F	.3125	9/16	9/16	8-32(2)

“SAV.” in front of any standard timing pulley part # represents the Shaft-Saver version. Shaft-Saver pulleys have special setscrews that grip without damage to the shaft and allow easy pulley removal and realignment. For additional information, see our Shaft-Saver Engineering Section.

York also manufactures custom pulleys and complete assemblies
 email:support@york-ind.com web: www.york-ind.com



ALUMINUM WITH CLEAR ANODIZE (RoHS compliant)

FOR BELTS UP TO 3/8" WIDE

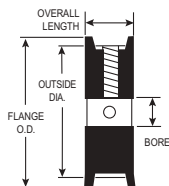

TYPE 3F

PART NUMBER	NO. OF GROOVES	PITCH DIA.	OUTSIDE DIA.	FLANGE O.D.	TYPE	BORE (+.001 / -.000)	FACE WIDTH	OVERALL LENGTH	SET SCREWS
20XL037-5A X 3/8	20	1.273	1.253	1 1/2	3F	.3750	9/16	9/16	8-32(2)
SAV-20XL037-5A X 3/8	20	1.273	1.253	1 1/2	3F	.3750	9/16	9/16	8-32(2)
21XL037-5A X 1/4	21	1.337	1.317	1 9/16	3F	.2500	9/16	9/16	8-32(2)
SAV-21XL037-5A X 1/4	21	1.337	1.317	1 9/16	3F	.2500	9/16	9/16	8-32(2)
21XL037-5A X 5/16	21	1.337	1.317	1 9/16	3F	.3125	9/16	9/16	8-32(2)
SAV-21XL037-5A X 5/16	21	1.337	1.317	1 9/16	3F	.3125	9/16	9/16	8-32(2)
22XL037-5A X 1/4	22	1.401	1.381	1 5/8	3F	.2500	9/16	9/16	8-32(2)
SAV-22XL037-5A X 1/4	22	1.401	1.381	1 5/8	3F	.2500	9/16	9/16	8-32(2)
22XL037-5A X 5/16	22	1.401	1.381	1 5/8	3F	.3125	9/16	9/16	8-32(2)
SAV-22XL037-5A X 5/16	22	1.401	1.381	1 5/8	3F	.3125	9/16	9/16	8-32(2)
24XL037-5A X 1/4	24	1.528	1.508	1 3/4	3F	.2500	9/16	9/16	8-32(2)
SAV-24XL037-5A X 1/4	24	1.528	1.508	1 3/4	3F	.2500	9/16	9/16	8-32(2)
24XL037-5A X 5/16	24	1.528	1.508	1 3/4	3F	.3125	9/16	9/16	8-32(2)
SAV-24XL037-5A X 5/16	24	1.528	1.508	1 3/4	3F	.3125	9/16	9/16	8-32(2)
24XL037-5A X 3/8	24	1.528	1.508	1 3/4	3F	.3750	9/16	9/16	8-32(2)
SAV-24XL037-5A X 3/8	24	1.528	1.508	1 3/4	3F	.3750	9/16	9/16	8-32(2)
28XL037-5A X 1/4	28	1.783	1.763	2	3F	.2500	9/16	9/16	8-32(2)
SAV-28XL037-5A X 1/4	28	1.783	1.763	2	3F	.2500	9/16	9/16	8-32(2)
28XL037-5A X 3/8	28	1.783	1.763	2	3F	.3750	9/16	9/16	8-32(2)
SAV-28XL037-5A X 3/8	28	1.783	1.763	2	3F	.3750	9/16	9/16	8-32(2)
30XL037-5A X 1/4	30	1.910	1.890	2 1/8	3F	.2500	9/16	9/16	8-32(2)
SAV-30XL037-5A X 1/4	30	1.910	1.890	2 1/8	3F	.2500	9/16	9/16	8-32(2)
30XL037-5A X 3/8	30	1.910	1.890	2 1/8	3F	.3750	9/16	9/16	8-32(2)
SAV-30XL037-5A X 3/8	30	1.910	1.890	2 1/8	3F	.3750	9/16	9/16	8-32(2)
32XL037-5A X 5/16	32	2.037	2.017	2 1/4	3F	.3125	9/16	9/16	8-32(2)
SAV-32XL037-5A X 5/16	32	2.037	2.017	2 1/4	3F	.3125	9/16	9/16	8-32(2)
32XL037-5A X 3/8	32	2.037	2.017	2 1/4	3F	.3750	9/16	9/16	8-32(2)
SAV-32XL037-5A X 3/8	32	2.037	2.017	2 1/4	3F	.3750	9/16	9/16	8-32(2)

“SAV-” in front of any standard timing pulley part # represents the Shaft-Saver version. Shaft-Saver pulleys have special setscrews that grip without damage to the shaft and allow easy pulley removal and realignment. For additional information, see our Shaft-Saver Engineering Section.

STEEL WITH BLACK OXIDE (RoHS compliant)

FOR BELTS UP TO 3/8" WIDE

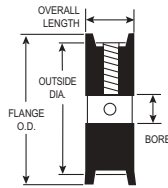

TYPE 3F



PART NUMBER	NO. OF GROOVES	PITCH DIA.	OUTSIDE DIA.	FLANGE O.D.	TYPE	BORE (+.001 / -.000)	FACE WIDTH	OVERALL LENGTH	SET SCREWS
10XL037-5S X 3/16	10	.637	.617	7/8	3F	.1875	9/16	9/16	6-32(1)
SAV-10XL037-5S X 3/16	10	.637	.617	7/8	3F	.1875	9/16	9/16	6-32(1)
10XL037-5S X 1/4	10	.637	.617	7/8	3F	.2500	9/16	9/16	6-32(1)
SAV-10XL037-5S X 1/4	10	.637	.617	7/8	3F	.2500	9/16	9/16	6-32(1)
11XL037-5S X 3/16	11	.700	.680	15/16	3F	.1875	9/16	9/16	6-32(1)
SAV-11XL037-5S X 3/16	11	.700	.680	15/16	3F	.1875	9/16	9/16	6-32(1)
11XL037-5S X 1/4	11	.700	.680	15/16	3F	.2500	9/16	9/16	6-32(1)
SAV-11XL037-5S X 1/4	11	.700	.680	15/16	3F	.2500	9/16	9/16	6-32(1)
12XL037-5S X 3/16	12	.764	.744	1	3F	.1875	9/16	9/16	6-32(1)
SAV-12XL037-5S X 3/16	12	.764	.744	1	3F	.1875	9/16	9/16	6-32(1)
12XL037-5S X 1/4	12	.764	.744	1	3F	.2500	9/16	9/16	8-32(1)
SAV-12XL037-5S X 1/4	12	.764	.744	1	3F	.2500	9/16	9/16	8-32(1)
14XL037-5S X 1/4	14	.891	.871	1 3/32	3F	.2500	9/16	9/16	8-32(2)
SAV-14XL037-5S X 1/4	14	.891	.871	1 3/32	3F	.2500	9/16	9/16	8-32(2)
15XL037-5S X 1/4	15	.955	.935	1 3/16	3F	.2500	9/16	9/16	8-32(2)
SAV-15XL037-5S X 1/4	15	.955	.935	1 3/16	3F	.2500	9/16	9/16	8-32(2)
15XL037-5S X 5/16	15	.955	.935	1 3/16	3F	.3125	9/16	9/16	8-32(2)
SAV-15XL037-5S X 5/16	15	.955	.935	1 3/16	3F	.3125	9/16	9/16	8-32(2)
16XL037-5S X 1/4	16	1.019	.999	1 1/4	3F	.2500	9/16	9/16	8-32(2)
SAV-16XL037-5S X 1/4	16	1.019	.999	1 1/4	3F	.2500	9/16	9/16	8-32(2)
16XL037-5S X 5/16	16	1.019	.999	1 1/4	3F	.3125	9/16	9/16	8-32(2)
SAV-16XL037-5S X 5/16	16	1.019	.999	1 1/4	3F	.3125	9/16	9/16	8-32(2)
18XL037-5S X 1/4	18	1.146	1.126	1 3/8	3F	.2500	9/16	9/16	8-32(2)
SAV-18XL037-5S X 1/4	18	1.146	1.126	1 3/8	3F	.2500	9/16	9/16	8-32(2)
18XL037-5S X 5/16	18	1.146	1.126	1 3/8	3F	.3125	9/16	9/16	8-32(2)
SAV-18XL037-5S X 5/16	18	1.146	1.126	1 3/8	3F	.3125	9/16	9/16	8-32(2)
20XL037-5S X 1/4	20	1.273	1.253	1 1/2	3F	.2500	9/16	9/16	8-32(2)
SAV-20XL037-5S X 1/4	20	1.273	1.253	1 1/2	3F	.2500	9/16	9/16	8-32(2)

“SAV.” in front of any standard timing pulley part # represents the Shaft-Saver version. Shaft-Saver pulleys have special setscrews that grip without damage to the shaft and allow easy pulley removal and realignment. For additional information, see our Shaft-Saver Engineering Section.

York also manufactures custom pulleys and complete assemblies
 email:support@york-ind.com web: www.york-ind.com



STEEL WITH BLACK OXIDE (RoHS compliant)

FOR BELTS UP TO 3/8" WIDE

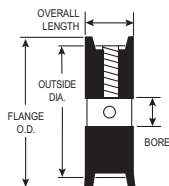

TYPE 3F

PART NUMBER	NO. OF GROOVES	PITCH DIA.	OUTSIDE DIA.	FLANGE O.D.	TYPE	BORE (+.001) (-.000)	FACE WIDTH	OVERALL LENGTH	SET SCREWS
20XL037-5S X 5/16	20	1.273	1.253	1 1/2	3F	.3125	9/16	9/16	8-32(2)
SAV-20XL037-5S X 5/16	20	1.273	1.253	1 1/2	3F	.3125	9/16	9/16	8-32(2)
20XL037-5S X 3/8	20	1.273	1.253	1 1/2	3F	.3750	9/16	9/16	8-32(2)
SAV-20XL037-5S X 3/8	20	1.273	1.253	1 1/2	3F	.3750	9/16	9/16	8-32(2)
21XL037-5S X 1/4	21	1.337	1.317	1 9/16	3F	.2500	9/16	9/16	8-32(2)
SAV-21XL037-5S X 1/4	21	1.337	1.317	1 9/16	3F	.2500	9/16	9/16	8-32(2)
21XL037-5S X 5/16	21	1.337	1.317	1 9/16	3F	.3125	9/16	9/16	8-32(2)
SAV-21XL037-5S X 5/16	21	1.337	1.317	1 9/16	3F	.3125	9/16	9/16	8-32(2)
22XL037-5S X 1/4	22	1.401	1.381	1 5/8	3F	.2500	9/16	9/16	8-32(2)
SAV-22XL037-5S X 1/4	22	1.401	1.381	1 5/8	3F	.2500	9/16	9/16	8-32(2)
22XL037-5S X 5/16	22	1.401	1.381	1 5/8	3F	.3125	9/16	9/16	8-32(2)
SAV-22XL037-5S X 5/16	22	1.401	1.381	1 5/8	3F	.3125	9/16	9/16	8-32(2)
24XL037-5S X 1/4	24	1.528	1.508	1 3/4	3F	.2500	9/16	9/16	8-32(2)
SAV-24XL037-5S X 1/4	24	1.528	1.508	1 3/4	3F	.2500	9/16	9/16	8-32(2)
24XL037-5S X 5/16	24	1.528	1.508	1 3/4	3F	.3125	9/16	9/16	8-32(2)
SAV-24XL037-5S X 5/16	24	1.528	1.508	1 3/4	3F	.3125	9/16	9/16	8-32(2)
24XL037-5S X 3/8	24	1.528	1.508	1 3/4	3F	.3750	9/16	9/16	8-32(2)
SAV-24XL037-5S X 3/8	24	1.528	1.508	1 3/4	3F	.3750	9/16	9/16	8-32(2)
28XL037-5S X 1/4	28	1.783	1.763	2	3F	.2500	9/16	9/16	8-32(2)
SAV-28XL037-5S X 1/4	28	1.783	1.763	2	3F	.2500	9/16	9/16	8-32(2)
28XL037-5S X 3/8	28	1.783	1.763	2	3F	.3750	9/16	9/16	8-32(2)
SAV-28XL037-5S X 3/8	28	1.783	1.763	2	3F	.3750	9/16	9/16	8-32(2)
30XL037-5S X 1/4	30	1.910	1.890	2 1/8	3F	.2500	9/16	9/16	8-32(2)
SAV-30XL037-5S X 1/4	30	1.910	1.890	2 1/8	3F	.2500	9/16	9/16	8-32(2)
30XL037-5S X 3/8	30	1.910	1.890	2 1/8	3F	.3750	9/16	9/16	8-32(2)
SAV-30XL037-5S X 3/8	30	1.910	1.890	2 1/8	3F	.3750	9/16	9/16	8-32(2)
32XL037-5S X 5/16	32	2.037	2.017	2 1/4	3F	.3125	9/16	9/16	8-32(2)
SAV-32XL037-5S X 5/16	32	2.037	2.017	2 1/4	3F	.3125	9/16	9/16	8-32(2)
32XL037-5S X 3/8	32	2.037	2.017	2 1/4	3F	.3750	9/16	9/16	8-32(2)
SAV-32XL037-5S X 3/8	32	2.037	2.017	2 1/4	3F	.3750	9/16	9/16	8-32(2)

"SAV." in front of any standard timing pulley part # represents the Shaft-Saver version. Shaft-Saver pulleys have special setscrews that grip without damage to the shaft and allow easy pulley removal and realignment. For additional information, see our Shaft-Saver Engineering Section.

ALUMINUM (RoHS compliant)

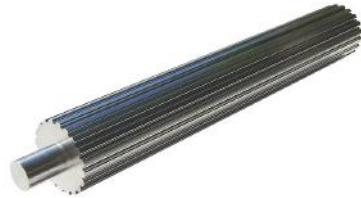
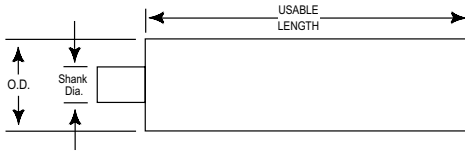

PART NUMBER	NO. OF GROOVES	PITCH DIA.	OUTSIDE DIA.	SHANK DIA.	USEABLE LENGTH	PART NUMBER	NO. OF GROOVES	PITCH DIA.	OUTSIDE DIA.	SHANK DIA.	USEABLE LENGTH
10XL-P-6A	10	.637	.617	1/2	6"	28XL-P-8A	28	1.783	1.763	1/2	8"
11XL-P-6A	11	.700	.680	1/2	6"	29XL-P-8A	29	1.846	1.826	1/2	8"
						30XL-P-8A	30	1.910	1.890	1/2	8"
12XL-P-8A	12	.764	.744	1/2	8"	31XL-P-8A	31	1.974	1.954	1/2	8"
13XL-P-8A	13	.828	.808	1/2	8"	32XL-P-8A	32	2.037	2.017	1/2	8"
14XL-P-8A	14	.891	.871	1/2	8"	33XL-P-8A	33	2.101	2.081	1/2	8"
15XL-P-8A	15	.955	.935	1/2	8"	34XL-P-8A	34	2.165	2.145	1/2	8"
16XL-P-8A	16	1.019	.999	1/2	8"	35XL-P-8A	35	2.228	2.208	1/2	8"
17XL-P-8A	17	1.082	1.062	1/2	8"	36XL-P-8A	36	2.292	2.272	3/4	8"
18XL-P-8A	18	1.146	1.126	1/2	8"	37XL-P-8A	37	2.355	2.335	3/4	8"
19XL-P-8A	19	1.210	1.190	1/2	8"	38XL-P-8A	38	2.419	2.399	3/4	8"
20XL-P-8A	20	1.273	1.253	1/2	8"	40XL-P-8A	40	2.546	2.526	3/4	8"
21XL-P-8A	21	1.337	1.317	1/2	8"	42XL-P-8A	42	2.674	2.654	3/4	8"
22XL-P-8A	22	1.401	1.381	1/2	8"	44XL-P-8A	44	2.801	2.781	3/4	8"
23XL-P-8A	23	1.464	1.444	1/2	8"	45XL-P-8A	45	2.865	2.845	3/4	8"
24XL-P-8A	24	1.528	1.508	1/2	8"	48XL-P-8A	48	3.056	3.036	3/4	8"
25XL-P-8A	25	1.592	1.572	1/2	8"	50XL-P-8A	50	3.183	3.163	3/4	8"
26XL-P-8A	26	1.655	1.635	1/2	8"	60XL-P-8A	60	3.820	3.800	3/4	8"
27XL-P-8A	27	1.719	1.699	1/2	8"	72XL-P-8A	72	4.584	4.564	1	8"

“SAV-” in front of any standard timing pulley part # represents the Shaft-Saver version. Shaft-Saver pulleys have special setscrews that grip without damage to the shaft and allow easy pulley removal and realignment. For additional information, see our Shaft-Saver Engineering Section.

York also manufactures custom pulleys and complete assemblies
 email:support@york-ind.com web: www.york-ind.com



ALUMINUM (RoHS compliant)

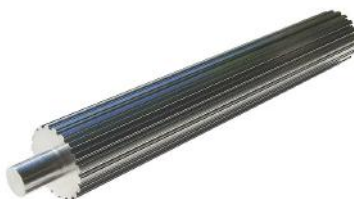
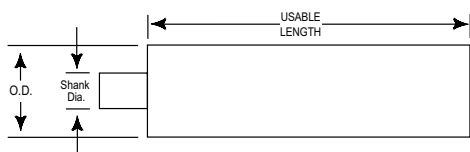

PART NUMBER	NO. OF GROOVES	PITCH DIA.	OUTSIDE DIA.	SHANK DIA.	USEABLE LENGTH	PART NUMBER	NO. OF GROOVES	PITCH DIA.	OUTSIDE DIA.	SHANK DIA.	USEABLE LENGTH
18XL-P-12A	18	1.146	1.126	1/2	12"	35XL-P-12A	35	2.228	2.208	1/2	12"
19XL-P-12A	19	1.210	1.190	1/2	12"	36XL-P-12A	36	2.292	2.272	3/4	12"
20XL-P-12A	20	1.273	1.253	1/2	12"	37XL-P-12A	37	2.355	2.335	3/4	12"
21XL-P-12A	21	1.337	1.317	1/2	12"	38XL-P-12A	38	2.419	2.399	3/4	12"
22XL-P-12A	22	1.401	1.381	1/2	12"	39XL-P-12A	39	2.483	2.463	3/4	12"
23XL-P-12A	23	1.464	1.444	1/2	12"	40XL-P-12A	40	2.546	2.526	3/4	12"
24XL-P-12A	24	1.528	1.508	1/2	12"	41XL-P-12A	41	2.610	2.590	3/4	12"
25XL-P-12A	25	1.592	1.572	1/2	12"	42XL-P-12A	42	2.674	2.654	3/4	12"
26XL-P-12A	26	1.655	1.635	1/2	12"	44XL-P-12A	44	2.801	2.781	3/4	12"
27XL-P-12A	27	1.719	1.699	1/2	12"	45XL-P-12A	45	2.865	2.845	3/4	12"
28XL-P-12A	28	1.783	1.763	1/2	12"	48XL-P-12A	48	3.056	3.036	3/4	12"
29XL-P-12A	29	1.846	1.826	1/2	12"	50XL-P-12A	50	3.183	3.163	3/4	12"
30XL-P-12A	30	1.910	1.890	1/2	12"	54XL-P-12A	54	3.438	3.418	3/4	12"
31XL-P-12A	31	1.974	1.954	1/2	12"	60XL-P-12A	60	3.820	3.800	3/4	12"
32XL-P-12A	32	2.037	2.017	1/2	12"	64XL-P-12A	64	4.074	4.054	3/4	12"
33XL-P-12A	33	2.101	2.081	1/2	12"	72XL-P-12A	72	4.584	4.564	1	12"
34XL-P-12A	34	2.165	2.145	1/2	12"						

"SAV." in front of any standard timing pulley part # represents the Shaft-Saver version. Shaft-Saver pulleys have special setscrews that grip without damage to the shaft and allow easy pulley removal and realignment. For additional information, see our Shaft-Saver Engineering Section.

STEEL (RoHS compliant)

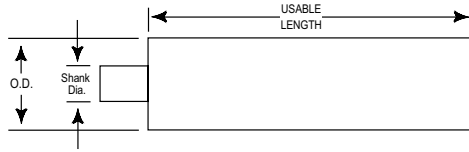

PART NUMBER	NO. OF GROOVES	PITCH DIA.	OUTSIDE DIA.	SHANK DIA.	USEABLE LENGTH	PART NUMBER	NO. OF GROOVES	PITCH DIA.	OUTSIDE DIA.	SHANK DIA.	USEABLE LENGTH
10XL-P-8S	10	.637	.617	1/2	6"	28XL-P-8S	28	1.783	1.763	1/2	8"
11XL-P-8S	11	.700	.680	1/2	6"	29XL-P-8S	29	1.846	1.826	1/2	8"
12XL-P-8S	12	.764	.744	1/2	8"	30XL-P-8S	30	1.910	1.890	1/2	8"
13XL-P-8S	13	.828	.808	1/2	8"	31XL-P-8S	31	1.974	1.954	1/2	8"
14XL-P-8S	14	.891	.871	1/2	8"	32XL-P-8S	32	2.037	2.017	1/2	8"
15XL-P-8S	15	.955	.935	1/2	8"	33XL-P-8S	33	2.101	2.081	1/2	8"
16XL-P-8S	16	1.019	.999	1/2	8"	34XL-P-8S	34	2.165	2.145	1/2	8"
17XL-P-8S	17	1.082	1.062	1/2	8"	35XL-P-8S	35	2.228	2.208	1/2	8"
18XL-P-8S	18	1.146	1.126	1/2	8"	36XL-P-8S	36	2.292	2.272	3/4	8"
19XL-P-8S	19	1.210	1.190	1/2	8"	37XL-P-8S	37	2.355	2.335	3/4	8"
20XL-P-8S	20	1.273	1.253	1/2	8"	38XL-P-8S	38	2.419	2.399	3/4	8"
21XL-P-8S	21	1.337	1.317	1/2	8"	40XL-P-8S	40	2.546	2.526	3/4	8"
22XL-P-8S	22	1.401	1.381	1/2	8"	42XL-P-8S	42	2.674	2.654	3/4	8"
23XL-P-8S	23	1.464	1.444	1/2	8"	44XL-P-8S	44	2.801	2.781	3/4	8"
24XL-P-8S	24	1.528	1.508	1/2	8"	45XL-P-8S	45	2.865	2.845	3/4	8"
25XL-P-8S	25	1.592	1.572	1/2	8"	48XL-P-8S	48	3.056	3.036	3/4	8"
26XL-P-8S	26	1.655	1.635	1/2	8"	50XL-P-8S	50	3.183	3.163	3/4	8"
27XL-P-8S	27	1.719	1.699	1/2	8"	60XL-P-8S	60	3.820	3.800	3/4	8"
						72XL-P-8S	72	4.584	4.564	1	8"

“SAV-” in front of any standard timing pulley part # represents the Shaft-Saver version. Shaft-Saver pulleys have special setscrews that grip without damage to the shaft and allow easy pulley removal and realignment. For additional information, see our Shaft-Saver Engineering Section.

York also manufactures custom pulleys and complete assemblies
 email:support@york-ind.com web: www.york-ind.com



STEEL (RoHS compliant)

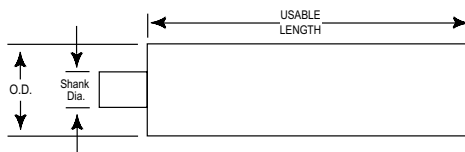
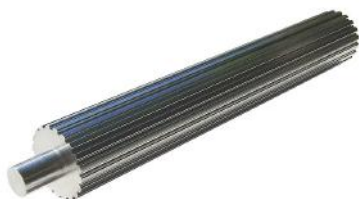

PART NUMBER	NO. OF GROOVES	PITCH DIA.	OUTSIDE DIA.	SHANK DIA.	USEABLE LENGTH	PART NUMBER	NO. OF GROOVES	PITCH DIA.	OUTSIDE DIA.	SHANK DIA.	USEABLE LENGTH
18XL-P-12S	18	1.146	1.126	1/2	12"	32XL-P-12S	32	2.037	2.017	1/2	12"
19XL-P-12S	19	1.210	1.190	1/2	12"	34XL-P-12S	34	2.165	2.145	1/2	12"
20XL-P-12S	20	1.273	1.253	1/2	12"	36XL-P-12S	36	2.292	2.272	3/4	12"
21XL-P-12S	21	1.337	1.317	1/2	12"	38XL-P-12S	38	2.419	2.399	3/4	12"
22XL-P-12S	22	1.401	1.381	1/2	12"	40XL-P-12S	40	2.546	2.526	3/4	12"
24XL-P-12S	24	1.528	1.508	1/2	12"	42XL-P-12S	42	2.674	2.654	3/4	12"
25XL-P-12S	25	1.592	1.572	1/2	12"	44XL-P-12S	44	2.801	2.781	3/4	12"
26XL-P-12S	26	1.655	1.635	1/2	12"	45XL-P-12S	45	2.865	2.845	3/4	12"
27XL-P-12S	27	1.719	1.699	1/2	12"	48XL-P-12S	48	3.056	3.036	3/4	12"
28XL-P-12S	28	1.783	1.763	1/2	12"	50XL-P-12S	50	3.183	3.163	3/4	12"
29XL-P-12S	29	1.846	1.826	1/2	12"	60XL-P-12S	60	3.820	3.800	3/4	12"
30XL-P-12S	30	1.910	1.890	1/2	12"	72XL-P-12S	72	4.584	4.564	1	12"

ALUMINUM (RoHS compliant)

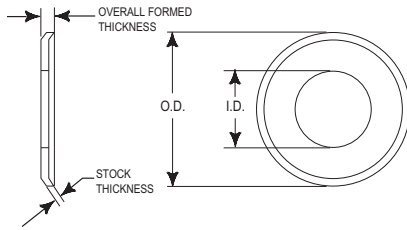

PART NUMBER	INSIDE DIA.	OUTSIDE DIA.	STOCK THICKNESS	OVERALL FORMED THICKNESS
10XL-F2A	.503	7/8	.040	.065
11XL-F2A	.562	15/16	.040	.065
12XL-F2A	.562	1	.040	.065
13XL-F2A	.625	1 1/16	.040	.065
14XL-F2A	.684	1 3/32	.040	.065
15XL-F2A	.748	1 3/16	.040	.065
16XL-F2A	.810	1 1/4	.040	.065
17XL-F2A	.887	1 5/16	.040	.065
18XL-F2A	.936	1 3/8	.040	.065
19XL-F2A	1.000	1 7/16	.040	.065
20XL-F2A	1.062	1 1/2	.040	.065
21XL-F2A	1.125	1 9/16	.040	.065
22XL-F2A	1.160	1 5/8	.040	.065
23XL-F2A	1.160	1 11/16	.040	.065
24XL-F2A	1.222	1 3/4	.040	.065
25XL-F2A	1.250	1 13/16	.040	.065
26XL-F2A	1.347	1 7/8	.040	.065
28XL-F2A	1.425	2	.040	.065
30XL-F2A	1.550	2 1/8	.040	.065
32XL-F2A	1.675	2 1/4	.040	.065

York also manufactures custom pulleys and complete assemblies
 email: support@york-ind.com web: www.york-ind.com



STEEL (RoHS compliant)

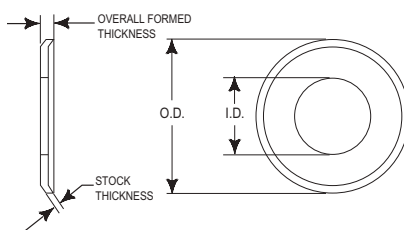

PART NUMBER	INSIDE DIA.	OUTSIDE DIA.	STOCK THICKNESS	OVERALL FORMED THICKNESS
10XL-F3S	.503	7/8	.040	.065
11XL-F3S	.562	15/16	.040	.065
12XL-F3S	.562	1	.040	.065
13XL-F3S	.625	1 1/16	.040	.065
14XL-F3S	.684	1 3/32	.040	.065
15XL-F3S	.748	1 3/16	.040	.065
16XL-F3S	.810	1 1/4	.040	.065
17XL-F3S	.887	1 5/16	.040	.065
18XL-F3S	.936	1 3/8	.040	.065
19XL-F3S	1.000	1 7/16	.040	.065
20XL-F3S	1.062	1 1/2	.040	.065
21XL-F3S	1.125	1 9/16	.040	.065
22XL-F3S	1.160	1 5/8	.040	.065
23XL-F3S	1.160	1 11/16	.040	.065
24XL-F3S	1.222	1 3/4	.040	.065
25XL-F3S	1.250	1 13/16	.040	.065
26XL-F3S	1.347	1 7/8	.040	.065
28XL-F3S	1.425	2	.040	.065
30XL-F3S	1.550	2 1/8	.040	.065
32XL-F3S	1.675	2 1/4	.040	.065

BLACK NEOPRENE, Fiberglass Cord (RoHS compliant)

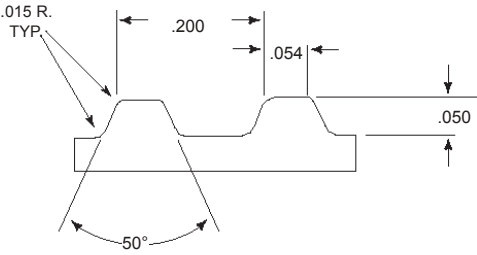

BELT NUMBER	WIDTHS		PITCH LENGTH	NO. OF TEETH	BELT NUMBER	WIDTHS		PITCH LENGTH	NO. OF TEETH
	1/4"	3/8"				1/4"	3/8"		
42XL	025	037	4.2	21	106XL	025	037	10.6	53
50XL	025	037	5.0	25	108XL	025	037	10.8	54
54XL	025	037	5.4	27	110XL	025	037	11.0	55
56XL	025	037	5.6	28	112XL	025	037	11.2	56
58XL	025	037	5.8	29	114XL	025	037	11.4	57
60XL	025	037	6.0	30	116XL	025	037	11.6	58
62XL	025	037	6.2	31	118XL	025	037	11.8	59
64XL	025	037	6.4	32	120XL	025	037	12.0	60
66XL	025	037	6.6	33	122XL	025	037	12.2	61
68XL	025	037	6.8	34	124XL	025	037	12.4	62
70XL	025	037	7.0	35	126XL	025	037	12.6	63
72XL	025	037	7.2	36	128XL	025	037	12.8	64
74XL	025	037	7.4	37	130XL	025	037	13.0	65
76XL	025	037	7.6	38	132XL	025	037	13.2	66
78XL	025	037	7.8	39	134XL	025	037	13.4	67
80XL	025	037	8.0	40	136XL	025	037	13.6	68
82XL	025	037	8.2	41	138XL	025	037	13.8	69
84XL	025	037	8.4	42	140XL	025	037	14.0	70
86XL	025	037	8.6	43	142XL	025	037	14.2	71
88XL	025	037	8.8	44	144XL	025	037	14.4	72
90XL	025	037	9.0	45	146XL	025	037	14.6	73
92XL	025	037	9.2	46	148XL	025	037	14.8	74
94XL	025	037	9.4	47	150XL	025	037	15.0	75
96XL	025	037	9.6	48	152XL	025	037	15.2	76
98XL	025	037	9.8	49	154XL	025	037	15.4	77
100XL	025	037	10.0	50	156XL	025	037	15.6	78
102XL	025	037	10.2	51	158XL	025	037	15.8	79

Need a clean, low dust belt? See TruMotion belts.

York also manufactures custom pulleys and complete assemblies
 email: support@york-ind.com web: www.york-ind.com



BLACK NEOPRENE, Fiberglass Cord (RoHS compliant)

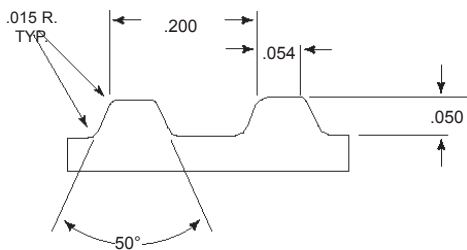

BELT NUMBER	WIDTHS		PITCH LENGTH	NO. OF TEETH	BELT NUMBER	WIDTHS		PITCH LENGTH	NO. OF TEETH
	1/4"	3/8"					1/4"		
160XL	025	037	16.0	80	214XL	025	037	21.4	107
162XL	025	037	16.2	81	218XL	025	037	21.8	109
164XL	025	037	16.4	82	220XL	025	037	22.0	110
166XL	025	037	16.6	83	222XL	025	037	22.2	111
168XL	025	037	16.8	84	226XL	025	037	22.6	113
170XL	025	037	17.0	85	228XL	025	037	22.8	114
172XL	025	037	17.2	86	230XL	025	037	23.0	115
174XL	025	037	17.4	87	232XL	025	037	23.2	116
176XL	025	037	17.6	88	234XL	025	037	23.4	117
178XL	025	037	17.8	89	236XL	025	037	23.6	118
180XL	025	037	18.0	90	240XL	025	037	24.0	120
182XL	025	037	18.2	91	244XL	025	037	24.4	122
184XL	025	037	18.4	92	246XL	025	037	24.6	123
186XL	025	037	18.6	93	250XL	025	037	25.0	125
188XL	025	037	18.8	94	254XL	025	037	25.4	127
190XL	025	037	19.0	95	258XL	025	037	25.8	129
192XL	025	037	19.2	96	260XL	025	037	26.0	130
194XL	025	037	19.4	97	262XL	025	037	26.2	131
196XL	025	037	19.6	98	264XL	025	037	26.4	132
198XL	025	037	19.8	99	266XL	025	037	26.6	133
200XL	025	037	20.0	100	268XL	025	037	26.8	134
202XL	025	037	20.2	101	270XL	025	037	27.0	135
204XL	025	037	20.4	102	274XL	025	037	27.4	137
206XL	025	037	20.6	103	280XL	025	037	28.0	140
208XL	025	037	20.8	104	284XL	025	037	28.4	142
210XL	025	037	21.0	105	286XL	025	037	28.6	143
212XL	025	037	21.2	106	290XL	025	037	29.0	145

If you don't see the belt you need – call York!

YORK

ISO 9001: 2008 Registered

303 Nassau Blvd., Garden City Park, NY 11040

Tel: 1-800 354 8466 Fax: 1-800 354 8485

BLACK NEOPRENE, Fiberglass Cord (RoHS compliant)

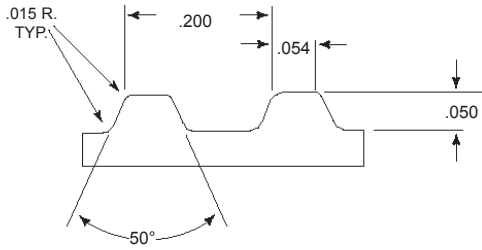

BELT NUMBER	WIDTHS		PITCH LENGTH	NO. OF TEETH	BELT NUMBER	WIDTHS		PITCH LENGTH	NO. OF TEETH
	1/4"	3/8"				1/4"	3/8"		
296XL	025	037	29.6	148	434XL	025	037	43.4	217
300XL	025	037	30.0	150	438XL	025	037	43.8	219
306XL	025	037	30.6	153	444XL	025	037	44.4	222
310XL	025	037	31.0	155	450XL	025	037	45.0	225
316XL	025	037	31.6	158	454XL	025	037	45.4	227
322XL	025	037	32.2	161	460XL	025	037	46.0	230
330XL	025	037	33.0	165	468XL	025	037	46.8	234
338XL	025	037	33.8	169	480XL	025	037	48.0	240
340XL	025	037	34.0	170	486XL	025	037	48.6	243
344XL	025	037	34.4	172	490XL	025	037	49.0	245
348XL	025	037	34.8	174	492XL	025	037	49.2	246
350XL	025	037	35.0	175	498XL	025	037	49.8	249
352XL	025	037	35.2	176	500XL	025	037	50.0	250
362XL	025	037	36.2	181	506XL	025	037	50.6	253
370XL	025	037	37.0	185	524XL	025	037	52.4	262
372XL	025	037	37.2	186	540XL	025	037	54.0	270
380XL	025	037	38.0	190	554XL	025	037	55.4	277
382XL	025	037	38.2	191	570XL	025	037	57.0	285
384XL	025	037	38.4	192	580XL	025	037	58.0	290
390XL	025	037	39.0	195	592XL	025	037	59.2	296
392XL	025	037	39.2	196	612XL	025	037	61.2	306
400XL	025	037	40.0	200	630XL	025	037	63.0	315
404XL	025	037	40.4	202	672XL	025	037	67.2	336
412XL	025	037	41.2	206	690XL	025	037	69.0	345
420XL	025	037	42.0	210	736XL	025	037	73.6	368
424XL	025	037	42.4	212	770XL	025	037	77.0	385
432XL	025	037	43.2	216	850XL	025	037	85.0	425

Need a clean, low dust belt? See TruMotion belts.

York also manufactures custom pulleys and complete assemblies
 email: support@york-ind.com web: www.york-ind.com



URETHANE, Polyester Cord (RoHS compliant)

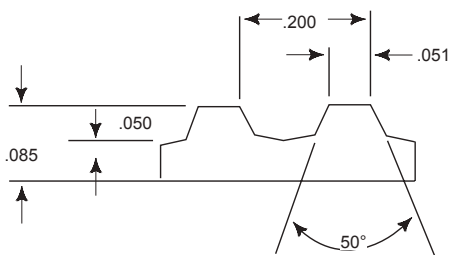

BELT NUMBER	WIDTHS		PITCH LENGTH	NO. OF TEETH	BELT NUMBER	WIDTHS		PITCH LENGTH	NO. OF TEETH
	1/4"	3/8"				1/4"	3/8"		
40XL-P	1/4	3/8	4.000	20	180XL-P	1/4	3/8	18.000	90
50XL-P	1/4	3/8	5.000	25	190XL-P	1/4	3/8	19.000	95
60XL-P	1/4	3/8	6.000	30	200XL-P	1/4	3/8	20.000	100
68XL-P	1/4	3/8	6.800	34	210XL-P	1/4	3/8	21.000	105
70XL-P	1/4	3/8	7.000	35	220XL-P	1/4	3/8	22.000	110
80XL-P	1/4	3/8	8.000	40	230XL-P	1/4	3/8	23.000	115
82XL-P	1/4	3/8	8.200	41	240XL-P	1/4	3/8	24.000	120
84XL-P	1/4	3/8	8.400	42	250XL-P	1/4	3/8	25.000	125
90XL-P	1/4	3/8	9.000	45	260XL-P	1/4	3/8	26.000	130
94XL-P	1/4	3/8	9.400	47	270XL-P	1/4	3/8	27.000	135
96XL-P	1/4	3/8	9.600	48	280XL-P	1/4	3/8	28.000	140
100XL-P	1/4	3/8	10.000	50	290XL-P	1/4	3/8	29.000	145
104XL-P	1/4	3/8	10.400	52	300XL-P	1/4	3/8	30.000	150
110XL-P	1/4	3/8	11.000	55	330XL-P	1/4	3/8	33.000	165
120XL-P	1/4	3/8	12.000	60	340XL-P	1/4	3/8	34.000	170
130XL-P	1/4	3/8	13.000	65	344XL-P	1/4	3/8	34.400	172
140XL-P	1/4	3/8	14.000	70	350XL-P	1/4	3/8	35.000	175
144XL-P	1/4	3/8	14.400	72	360XL-P	1/4	3/8	36.000	180
150XL-P	1/4	3/8	15.000	75	412XL-P	1/4	3/8	41.200	206
156XL-P	1/4	3/8	15.600	78	432XL-P	1/4	3/8	43.200	216
160XL-P	1/4	3/8	16.000	80	460XL-P	1/4	3/8	46.000	230
166XL-P	1/4	3/8	16.600	83	462XL-P	1/4	3/8	46.200	231
170XL-P	1/4	3/8	17.000	85	480XL-P	1/4	3/8	48.000	240
176XL-P	1/4	3/8	17.600	88	600XL-P	1/4	3/8	60.000	300

If you don't see the belt you need – call York!

YORK

ISO 9001: 2008 Registered

303 Nassau Blvd., Garden City Park, NY 11040

Tel: 1-800 354 8466 Fax: 1-800 354 8485

URETHANE, Kevlar Cord (RoHS compliant)

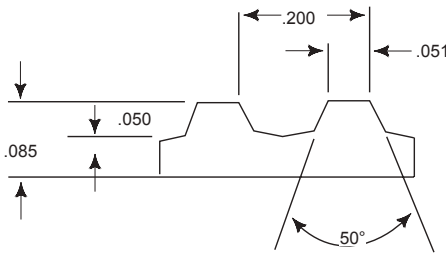

BELT NUMBER	WIDTHS		PITCH LENGTH	NO. OF TEETH	BELT NUMBER	WIDTHS		PITCH LENGTH	NO. OF TEETH
	1/4"	3/8"				1/4"	3/8"		
40XL-K	1/4	3/8	4.000	20	180XL-K	1/4	3/8	18.000	90
50XL-K	1/4	3/8	5.000	25	190XL-K	1/4	3/8	19.000	95
60XL-K	1/4	3/8	6.000	30	200XL-K	1/4	3/8	20.000	100
68XL-K	1/4	3/8	6.800	34	210XL-K	1/4	3/8	21.000	105
70XL-K	1/4	3/8	7.000	35	220XL-K	1/4	3/8	22.000	110
80XL-K	1/4	3/8	8.000	40	230XL-K	1/4	3/8	23.000	115
82XL-K	1/4	3/8	8.200	41	240XL-K	1/4	3/8	24.000	120
84XL-K	1/4	3/8	8.400	42	250XL-K	1/4	3/8	25.000	125
90XL-K	1/4	3/8	9.000	45	260XL-K	1/4	3/8	26.000	130
94XL-K	1/4	3/8	9.400	47	270XL-K	1/4	3/8	27.000	135
96XL-K	1/4	3/8	9.600	48	280XL-K	1/4	3/8	28.000	140
100XL-K	1/4	3/8	10.000	50	290XL-K	1/4	3/8	29.000	145
104XL-K	1/4	3/8	10.400	52	300XL-K	1/4	3/8	30.000	150
110XL-K	1/4	3/8	11.000	55	330XL-K	1/4	3/8	33.000	165
120XL-K	1/4	3/8	12.000	60	340XL-K	1/4	3/8	34.000	170
130XL-K	1/4	3/8	13.000	65	344XL-K	1/4	3/8	34.400	172
140XL-K	1/4	3/8	14.000	70	350XL-K	1/4	3/8	35.000	175
144XL-K	1/4	3/8	14.400	72	360XL-K	1/4	3/8	36.000	180
150XL-K	1/4	3/8	15.000	75	412XL-K	1/4	3/8	41.200	206
156XL-K	1/4	3/8	15.600	78	432XL-K	1/4	3/8	43.200	216
160XL-K	1/4	3/8	16.000	80	460XL-K	1/4	3/8	46.000	230
166XL-K	1/4	3/8	16.600	83	462XL-K	1/4	3/8	46.200	231
170XL-K	1/4	3/8	17.000	85	480XL-K	1/4	3/8	48.000	240
176XL-K	1/4	3/8	17.600	88	600XL-K	1/4	3/8	60.000	300

If you don't see the belt you need – call York!

York also manufactures custom pulleys and complete assemblies
 email: support@york-ind.com web: www.york-ind.com



BLACK NEOPRENE, Fiberglass Cord (RoHS compliant)

TWIN POWER

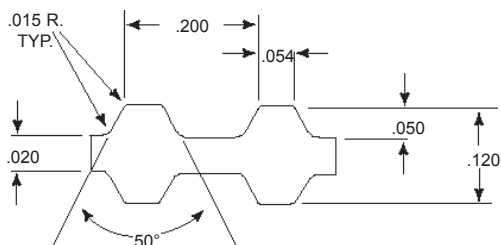

BELT NUMBER	WIDTHS		PITCH LENGTH	NO. OF TEETH
	1/4"	3/8"		
TP140XL	025	037	14.00	70
TP150XL	025	037	15.00	75
TP160XL	025	037	16.00	80
TP170XL	025	037	17.00	85
TP180XL	025	037	18.00	90
TP190XL	025	037	19.00	95
TP200XL	025	037	20.00	100
TP210XL	025	037	21.00	105
TP220XL	025	037	22.00	110
TP230XL	025	037	23.00	115
TP240XL	025	037	24.00	120
TP250XL	025	037	25.00	125
TP260XL	025	037	26.00	130
TP280XL	025	037	28.00	140
TP290XL	025	037	29.00	145
TP300XL	025	037	30.00	150
TP310XL	025	037	31.00	155
TP330XL	025	037	33.00	165
TP340XL	025	037	34.00	170

If you don't see the belt you need – call York!

YORK

ISO 9001: 2008 Registered

303 Nassau Blvd., Garden City Park, NY 11040

Tel: 1-800 354 8466 Fax: 1-800 354 8485

Cream Colored Engineered Polymer with Fiberglass Cord (RoHS compliant)

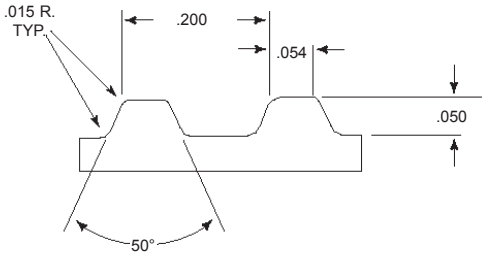

BELT NUMBER	WIDTHS		PITCH LENGTH	NO. OF TEETH	BELT NUMBER	WIDTHS		PITCH LENGTH	NO. OF TEETH
	1/4"	3/8"				1/4"	3/8"		
TM-42XL	025	037	4.2	21	TM-106XL	025	037	10.6	53
TM-50XL	025	037	5.0	25	TM-108XL	025	037	10.8	54
TM-54XL	025	037	5.4	27	TM-110XL	025	037	11.0	55
TM-56XL	025	037	5.6	28	TM-112XL	025	037	11.2	56
TM-58XL	025	037	5.8	29	TM-114XL	025	037	11.4	57
TM-60XL	025	037	6.0	30	TM-116XL	025	037	11.6	58
TM-62XL	025	037	6.2	31	TM-118XL	025	037	11.8	59
TM-64XL	025	037	6.4	32	TM-120XL	025	037	12.0	60
TM-66XL	025	037	6.6	33	TM-122XL	025	037	12.2	61
TM-68XL	025	037	6.8	34	TM-124XL	025	037	12.4	62
TM-70XL	025	037	7.0	35	TM-126XL	025	037	12.6	63
TM-72XL	025	037	7.2	36	TM-128XL	025	037	12.8	64
TM-74XL	025	037	7.4	37	TM-130XL	025	037	13.0	65
TM-76XL	025	037	7.6	38	TM-132XL	025	037	13.2	66
TM-78XL	025	037	7.8	39	TM-134XL	025	037	13.4	67
TM-80XL	025	037	8.0	40	TM-136XL	025	037	13.6	68
TM-82XL	025	037	8.2	41	TM-138XL	025	037	13.8	69
TM-84XL	025	037	8.4	42	TM-140XL	025	037	14.0	70
TM-86XL	025	037	8.6	43	TM-142XL	025	037	14.2	71
TM-88XL	025	037	8.8	44	TM-144XL	025	037	14.4	72
TM-90XL	025	037	9.0	45	TM-146XL	025	037	14.6	73
TM-92XL	025	037	9.2	46	TM-148XL	025	037	14.8	74
TM-94XL	025	037	9.4	47	TM-150XL	025	037	15.0	75
TM-96XL	025	037	9.6	48	TM-152XL	025	037	15.2	76
TM-98XL	025	037	9.8	49	TM-154XL	025	037	15.4	77
TM-100XL	025	037	10.0	50	TM-156XL	025	037	15.6	78
TM-102XL	025	037	10.2	51	TM-158XL	025	037	15.8	79

If you don't see the belt you need – call York!

York also manufactures custom pulleys and complete assemblies
 email: support@york-ind.com web: www.york-ind.com



Cream Colored Engineered Polymer with Fiberglass Cord (RoHS compliant)

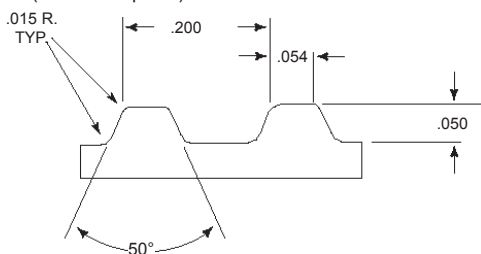

BELT NUMBER	WIDTHS		PITCH LENGTH	NO. OF TEETH	BELT NUMBER	WIDTHS		PITCH LENGTH	NO. OF TEETH
	1/4"	3/8"				1/4"	3/8"		
TM-160XL	025	037	16.0	80	TM-214XL	025	037	21.4	107
TM-162XL	025	037	16.2	81	TM-218XL	025	037	21.8	109
TM-164XL	025	037	16.4	82	TM-220XL	025	037	22.0	110
TM-166XL	025	037	16.6	83	TM-222XL	025	037	22.2	111
TM-168XL	025	037	16.8	84	TM-226XL	025	037	22.6	113
TM-170XL	025	037	17.0	85	TM-228XL	025	037	22.8	114
TM-172XL	025	037	17.2	86	TM-230XL	025	037	23.0	115
TM-174XL	025	037	17.4	87	TM-232XL	025	037	23.2	116
TM-176XL	025	037	17.6	88	TM-234XL	025	037	23.4	117
TM-178XL	025	037	17.8	89	TM-236XL	025	037	23.6	118
TM-180XL	025	037	18.0	90	TM-240XL	025	037	24.0	120
TM-182XL	025	037	18.2	91	TM-244XL	025	037	24.4	122
TM-184XL	025	037	18.4	92	TM-246XL	025	037	24.6	123
TM-186XL	025	037	18.6	93	TM-250XL	025	037	25.0	125
TM-188XL	025	037	18.8	94	TM-254XL	025	037	25.4	127
TM-190XL	025	037	19.0	95	TM-258XL	025	037	25.8	129
TM-192XL	025	037	19.2	96	TM-260XL	025	037	26.0	130
TM-194XL	025	037	19.4	97	TM-262XL	025	037	26.2	131
TM-196XL	025	037	19.6	98	TM-264XL	025	037	26.4	132
TM-198XL	025	037	19.8	99	TM-266XL	025	037	26.6	133
TM-200XL	025	037	20.0	100	TM-268XL	025	037	26.8	134
TM-202XL	025	037	20.2	101	TM-270XL	025	037	27.0	135
TM-204XL	025	037	20.4	102	TM-274XL	025	037	27.4	137
TM-206XL	025	037	20.6	103	TM-280XL	025	037	28.0	140
TM-208XL	025	037	20.8	104	TM-284XL	025	037	28.4	142
TM-210XL	025	037	21.0	105	TM-286XL	025	037	28.6	143
TM-212XL	025	037	21.2	106	TM-290XL	025	037	29.0	145

If you don't see the belt you need – call York!

YORK

ISO 9001: 2008 Registered

303 Nassau Blvd., Garden City Park, NY 11040

Tel: 1-800 354 8466 Fax: 1-800 354 8485

Cream Colored Engineered Polymer with Fiberglass Cord (RoHS compliant)

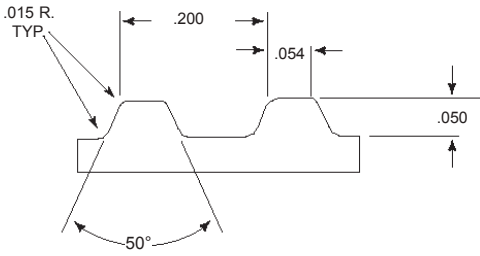

BELT NUMBER	WIDTHS		PITCH LENGTH	NO. OF TEETH	BELT NUMBER	WIDTHS		PITCH LENGTH	NO. OF TEETH
	1/4"	3/8"				1/4"	3/8"		
TM-296XL	025	037	29.6	148	TM-434XL	025	037	43.4	217
TM-300XL	025	037	30.0	150	TM-438XL	025	037	43.8	219
TM-306XL	025	037	30.6	153	TM-444XL	025	037	44.4	222
TM-310XL	025	037	31.0	155	TM-450XL	025	037	45.0	225
TM-316XL	025	037	31.6	158	TM-454XL	025	037	45.4	227
TM-322XL	025	037	32.2	161	TM-460XL	025	037	46.0	230
TM-330XL	025	037	33.0	165	TM-468XL	025	037	46.8	234
TM-338XL	025	037	33.8	169	TM-480XL	025	037	48.0	240
TM-340XL	025	037	34.0	170	TM-486XL	025	037	48.6	243
TM-344XL	025	037	34.4	172	TM-490XL	025	037	49.0	245
TM-348XL	025	037	34.8	174	TM-492XL	025	037	49.2	246
TM-350XL	025	037	35.0	175	TM-498XL	025	037	49.8	249
TM-352XL	025	037	35.2	176	TM-500XL	025	037	50.0	250
TM-362XL	025	037	36.2	181	TM-506XL	025	037	50.6	253
TM-370XL	025	037	37.0	185	TM-524XL	025	037	52.4	262
TM-372XL	025	037	37.2	186	TM-540XL	025	037	54.0	270
TM-380XL	025	037	38.0	190	TM-554XL	025	037	55.4	277
TM-382XL	025	037	38.2	191	TM-570XL	025	037	57.0	285
TM-384XL	025	037	38.4	192	TM-580XL	025	037	58.0	290
TM-390XL	025	037	39.0	195	TM-592XL	025	037	59.2	296
TM-392XL	025	037	39.2	196	TM-612XL	025	037	61.2	306
TM-400XL	025	037	40.0	200	TM-630XL	025	037	63.0	315
TM-404XL	025	037	40.4	202	TM-672XL	025	037	67.2	336
TM-412XL	025	037	41.2	206	TM-690XL	025	037	69.0	345
TM-420XL	025	037	42.0	210	TM-736XL	025	037	73.6	368
TM-424XL	025	037	42.4	212	TM-770XL	025	037	77.0	385
					TM-850XL	025	037	85.0	425

If you don't see the belt you need – call York!

York also manufactures custom pulleys and complete assemblies
 email: support@york-ind.com web: www.york-ind.com







ALUMINUM WITH CLEAR ANODIZE (RoHS compliant)

FOR BELTS UP TO 1/2" WIDE

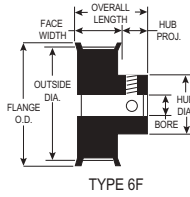

PART NUMBER	NO. OF GROOVES	PITCH DIA.	OUTSIDE DIA.	FLANGE O.D.	TYPE	BORE (+.001 (-.000))	FACE WIDTH	OVERALL LENGTH	HUB PROJ.	HUB DIA.	SET SCREWS (2@90°)
10L050-1A X 3/8	10	1.194	1.164	1 7/16	6F	.3750	3/4	1 1/8	3/8	13/16	10-32
SAV-10L050-1A X 3/8	10	1.194	1.164	1 7/16	6F	.3750	3/4	1 1/8	3/8	13/16	10-32
10L050-1A X 1/2	10	1.194	1.164	1 7/16	6F	.5000	3/4	1 1/8	3/8	13/16	1/4-20
SAV-10L050-1A X 1/2	10	1.194	1.164	1 7/16	6F	.5000	3/4	1 1/8	3/8	13/16	1/4-20
11L050-1A X 3/8	11	1.313	1.283	1 17/32	6F	.3750	3/4	1 1/8	3/8	15/16	10-32
SAV-11L050-1A X 3/8	11	1.313	1.283	1 17/32	6F	.3750	3/4	1 1/8	3/8	15/16	10-32
11L050-1A X 1/2	11	1.313	1.283	1 17/32	6F	.5000	3/4	1 1/8	3/8	15/16	1/4-20
SAV-11L050-1A X 1/2	11	1.313	1.283	1 17/32	6F	.5000	3/4	1 1/8	3/8	15/16	1/4-20
12L050-1A X 3/8	12	1.432	1.402	1 21/32	6F	.3750	3/4	1 1/4	1/2	1 1/16	10-32
SAV-12L050-1A X 3/8	12	1.432	1.402	1 21/32	6F	.3750	3/4	1 1/4	1/2	1 1/16	10-32
12L050-1A X 1/2	12	1.432	1.402	1 21/32	6F	.5000	3/4	1 1/4	1/2	1 1/16	1/4-20
SAV-12L050-1A X 1/2	12	1.432	1.402	1 21/32	6F	.5000	3/4	1 1/4	1/2	1 1/16	1/4-20
13L050-1A X 3/8	13	1.552	1.522	1 25/32	6F	.3750	3/4	1 1/4	1/2	1 1/8	10-32
SAV-13L050-1A X 3/8	13	1.552	1.522	1 25/32	6F	.3750	3/4	1 1/4	1/2	1 1/8	10-32
13L050-1A X 1/2	13	1.552	1.522	1 25/32	6F	.5000	3/4	1 1/4	1/2	1 1/8	1/4-20
SAV-13L050-1A X 1/2	13	1.552	1.522	1 25/32	6F	.5000	3/4	1 1/4	1/2	1 1/8	1/4-20
14L050-1A X 3/8	14	1.671	1.641	1 29/32	6F	.3750	3/4	1 1/4	1/2	1 1/8	10-32
SAV-14L050-1A X 3/8	14	1.671	1.641	1 29/32	6F	.3750	3/4	1 1/4	1/2	1 1/8	10-32
14L050-1A X 1/2	14	1.671	1.641	1 29/32	6F	.5000	3/4	1 1/4	1/2	1 1/8	1/4-20
SAV-14L050-1A X 1/2	14	1.671	1.641	1 29/32	6F	.5000	3/4	1 1/4	1/2	1 1/8	1/4-20
15L050-1A X 3/8	15	1.790	1.760	2 1/32	6F	.3750	3/4	1 1/4	1/2	1 1/4	10-32
SAV-15L050-1A X 3/8	15	1.790	1.760	2 1/32	6F	.3750	3/4	1 1/4	1/2	1 1/4	10-32
15L050-1A X 1/2	15	1.790	1.760	2 1/32	6F	.5000	3/4	1 1/4	1/2	1 1/4	1/4-20
SAV-15L050-1A X 1/2	15	1.790	1.760	2 1/32	6F	.5000	3/4	1 1/4	1/2	1 1/4	1/4-20
16L050-1A X 1/2	16	1.910	1.880	2 1/8	6F	.5000	3/4	1 3/8	5/8	1 7/16	1/4-20
SAV-16L050-1A X 1/2	16	1.910	1.880	2 1/8	6F	.5000	3/4	1 3/8	5/8	1 7/16	1/4-20
16L050-1A X 5/8	16	1.910	1.880	2 1/8	6F	.6250	3/4	1 3/8	5/8	1 7/16	1/4-20
SAV-16L050-1A X 5/8	16	1.910	1.880	2 1/8	6F	.6250	3/4	1 3/8	5/8	1 7/16	1/4-20
17L050-1A X 1/2	17	2.029	1.999	2 1/4	6F	.5000	3/4	1 3/8	5/8	1 1/2	1/4-20
SAV-17L050-1A X 1/2	17	2.029	1.999	2 1/4	6F	.5000	3/4	1 3/8	5/8	1 1/2	1/4-20

“SAV.” in front of any standard timing pulley part # represents the Shaft-Saver version. Shaft-Saver pulleys have special setscrews that grip without damage to the shaft and allow easy pulley removal and realignment. For additional information, see our Shaft-Saver Engineering Section.

York also manufactures custom pulleys and complete assemblies
 email:support@york-ind.com web: www.york-ind.com



ALUMINUM WITH CLEAR ANODIZE (RoHS compliant)

FOR BELTS UP TO 1/2" WIDE

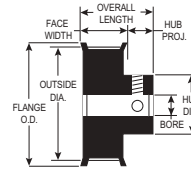

TYPE 6F

PART NUMBER	NO. OF GROOVES	PITCH DIA.	OUTSIDE DIA.	FLANGE O.D.	TYPE	BORE (+.001) (-.000)	FACE WIDTH	OVERALL LENGTH	HUB PROJ.	HUB DIA.	SET SCREWS (2@90°)
17L050-1A X 5/8	17	2.029	1.999	2 1/4	6F	.6250	3/4	1 3/8	5/8	1 1/2	1/4-20
SAV-17L050-1A X 5/8	17	2.029	1.999	2 1/4	6F	.6250	3/4	1 3/8	5/8	1 1/2	1/4-20
18L050-1A X 1/2	18	2.149	2.119	2 3/8	6F	.5000	3/4	1 3/8	5/8	1 5/8	1/4-20
SAV-18L050-1A X 1/2	18	2.149	2.119	2 3/8	6F	.5000	3/4	1 3/8	5/8	1 5/8	1/4-20
18L050-1A X 5/8	18	2.149	2.119	2 3/8	6F	.6250	3/4	1 3/8	5/8	1 5/8	1/4-20
SAV-18L050-1A X 5/8	18	2.149	2.119	2 3/8	6F	.6250	3/4	1 3/8	5/8	1 5/8	1/4-20
19L050-1A X 1/2	19	2.268	2.238	2 1/2	6F	.5000	3/4	1 3/8	5/8	1 11/16	1/4-20
SAV-19L050-1A X 1/2	19	2.268	2.238	2 1/2	6F	.5000	3/4	1 3/8	5/8	1 11/16	1/4-20
19L050-1A X 5/8	19	2.268	2.238	2 1/2	6F	.6250	3/4	1 3/8	5/8	1 11/16	1/4-20
SAV-19L050-1A X 5/8	19	2.268	2.238	2 1/2	6F	.6250	3/4	1 3/8	5/8	1 11/16	1/4-20
20L050-1A X 1/2	20	2.387	2.357	2 5/8	6F	.5000	3/4	1 3/8	5/8	1 11/16	1/4-20
SAV-20L050-1A X 1/2	20	2.387	2.357	2 5/8	6F	.5000	3/4	1 3/8	5/8	1 11/16	1/4-20
20L050-1A X 5/8	20	2.387	2.357	2 5/8	6F	.6250	3/4	1 3/8	5/8	1 11/16	1/4-20
SAV-20L050-1A X 5/8	20	2.387	2.357	2 5/8	6F	.6250	3/4	1 3/8	5/8	1 11/16	1/4-20
21L050-1A X 1/2	21	2.507	2.477	2 3/4	6F	.5000	3/4	1 1/2	3/4	1 7/8	1/4-20
SAV-21L050-1A X 1/2	21	2.507	2.477	2 3/4	6F	.5000	3/4	1 1/2	3/4	1 7/8	1/4-20
21L050-1A X 5/8	21	2.507	2.477	2 3/4	6F	.6250	3/4	1 1/2	3/4	1 7/8	1/4-20
SAV-21L050-1A X 5/8	21	2.507	2.477	2 3/4	6F	.6250	3/4	1 1/2	3/4	1 7/8	1/4-20
22L050-1A X 1/2	22	2.626	2.596	2 7/8	6F	.5000	3/4	1 1/2	3/4	2	1/4-20
SAV-22L050-1A X 1/2	22	2.626	2.596	2 7/8	6F	.5000	3/4	1 1/2	3/4	2	1/4-20
22L050-1A X 5/8	22	2.626	2.596	2 7/8	6F	.6250	3/4	1 1/2	3/4	2	1/4-20
SAV-22L050-1A X 5/8	22	2.626	2.596	2 7/8	6F	.6250	3/4	1 1/2	3/4	2	1/4-20
24L050-1A X 1/2	24	2.865	2.835	3 3/32	6F	.5000	3/4	1 1/2	3/4	2 1/4	1/4-20
SAV-24L050-1A X 1/2	24	2.865	2.835	3 3/32	6F	.5000	3/4	1 1/2	3/4	2 1/4	1/4-20
24L050-1A X 5/8	24	2.865	2.835	3 3/32	6F	.6250	3/4	1 1/2	3/4	2 1/4	1/4-20
SAV-24L050-1A X 5/8	24	2.865	2.835	3 3/32	6F	.6250	3/4	1 1/2	3/4	2 1/4	1/4-20

“SAV-” in front of any standard timing pulley part # represents the Shaft-Saver version. Shaft-Saver pulleys have special setscrews that grip without damage to the shaft and allow easy pulley removal and realignment. For additional information, see our Shaft-Saver Engineering Section.

ALUMINUM (RoHS compliant)

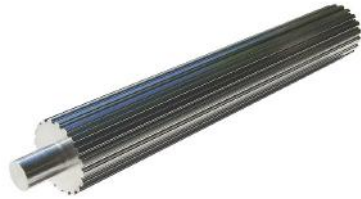
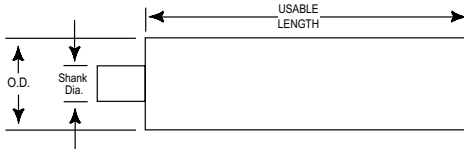

PART NUMBER	NO. OF GROOVES	PITCH DIA.	OUTSIDE DIA.	SHANK DIA.	USEABLE LENGTH	PART NUMBER	NO. OF GROOVES	PITCH DIA.	OUTSIDE DIA.	SHANK DIA.	USEABLE LENGTH
10L-P-8A	10	1.194	1.164	3/4	8"	12L-P-12A	12	1.432	1.402	1	12"
11L-P-8A	11	1.313	1.283	3/4	8"	14L-P-12A	14	1.671	1.641	1	12"
12L-P-8A	12	1.432	1.402	1	8"	15L-P-12A	15	1.790	1.760	1	12"
13L-P-8A	13	1.552	1.522	1	8"	16L-P-12A	16	1.910	1.880	1	12"
14L-P-8A	14	1.671	1.641	1	8"	18L-P-12A	18	2.149	2.119	1	12"
15L-P-8A	15	1.790	1.760	1	8"	20L-P-12A	20	2.387	2.357	1	12"
16L-P-8A	16	1.910	1.880	1	8"	21L-P-12A	21	2.507	2.477	1	12"
17L-P-8A	17	2.029	1.999	1	8"	22L-P-12A	22	2.626	2.596	1	12"
18L-P-8A	18	2.149	2.119	1	8"	24L-P-12A	24	2.865	2.835	1	12"
19L-P-8A	19	2.268	2.238	1	8"	28L-P-12A	28	3.342	3.312	1	12"
20L-P-8A	20	2.387	2.357	1	8"	30L-P-12A	30	3.581	3.551	1	12"
21L-P-8A	21	2.507	2.477	1	8"	32L-P-12A	32	3.820	3.790	1	12"
22L-P-8A	22	2.626	2.596	1	8"	36L-P-12A	36	4.297	4.267	1	12"
24L-P-8A	24	2.865	2.835	1	8"						
26L-P-8A	26	3.104	3.074	1	8"						
28L-P-8A	28	3.342	3.312	1	8"						
30L-P-8A	30	3.581	3.551	1	8"						
32L-P-8A	32	3.820	3.790	1	8"						
36L-P-8A	36	4.297	4.267	1	8"						
40L-P-10A	40	4.775	4.745	1	10"						
42L-P-10A	42	5.013	4.983	1	10"						
44L-P-10A	44	5.252	5.222	1	10"						
48L-P-10A	48	5.730	5.700	1	10"						

York also manufactures custom pulleys and complete assemblies
 email: support@york-ind.com web: www.york-ind.com



STEEL (RoHS compliant)

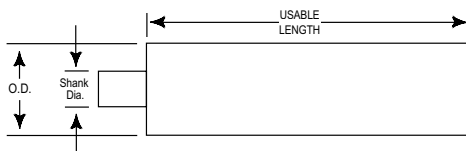
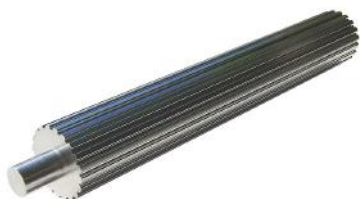

PART NUMBER	NO. OF GROOVES	PITCH DIA.	OUTSIDE DIA.	SHANK DIA.	USEABLE LENGTH
10L-P-8S	10	1.194	1.164	3/4	8"
11L-P-8S	11	1.313	1.283	3/4	8"
12L-P-8S	12	1.432	1.402	1	8"
13L-P-8S	13	1.552	1.522	1	8"
14L-P-8S	14	1.671	1.641	1	8"
15L-P-8S	15	1.790	1.760	1	8"
16L-P-8S	16	1.910	1.880	1	8"
17L-P-8S	17	2.029	1.999	1	8"
18L-P-8S	18	2.149	2.119	1	8"
19L-P-8S	19	2.268	2.238	1	8"
20L-P-8S	20	2.387	2.357	1	8"
21L-P-8S	21	2.507	2.477	1	8"
22L-P-8S	22	2.626	2.596	1	8"
24L-P-8S	24	2.865	2.835	1	8"
26L-P-8S	26	3.104	3.074	1	8"
28L-P-8S	28	3.342	3.312	1	8"
30L-P-8S	30	3.581	3.551	1	8"
32L-P-8S	32	3.820	3.790	1	8"
36L-P-8S	36	4.297	4.267	1	8"
12L-P-12S	12	1.432	1.402	1	12"
14L-P-12S	14	1.671	1.641	1	12"
15L-P-12S	15	1.790	1.760	1	12"
16L-P-12S	16	1.910	1.880	1	12"
18L-P-12S	18	2.149	2.119	1	12"
20L-P-12S	20	2.387	2.357	1	12"
21L-P-12S	21	2.507	2.477	1	12"
22L-P-12S	22	2.626	2.596	1	12"
24L-P-12S	24	2.865	2.835	1	12"
28L-P-12S	28	3.342	3.312	1	12"
30L-P-12S	30	3.581	3.551	1	12"
32L-P-12S	32	3.820	3.790	1	12"
36L-P-12S	36	4.297	4.267	1	12"

ALUMINUM (RoHS compliant)

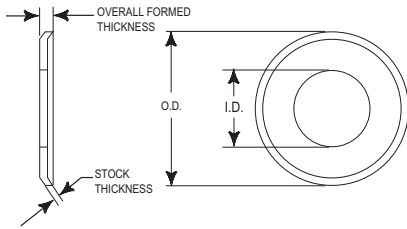

PART NUMBER	INSIDE DIA.	OUTSIDE DIA.	STOCK THICKNESS	OVERALL FORMED THICKNESS
10L-F4A	.976	1 7/16	.055	.090
11L-F4A	1.101	1 17/32	.055	.090
12L-F4A	1.226	1 21/32	.055	.090
13L-F4A	1.276	1 25/32	.055	.090
14L-F4A	1.401	1 29/32	.055	.090
15L-F4A	1.521	2 1/32	.055	.090
16L-F4A	1.578	2 1/8	.055	.090
17L-F4A	1.701	2 1/4	.055	.090
18L-F4A	1.824	2 3/8	.055	.090
19L-F4A	1.910	2 1/2	.055	.090
20L-F4A	2.035	2 5/8	.055	.090
21L-F4A	2.120	2 3/4	.055	.090
22L-F4A	2.241	2 7/8	.055	.090
24L-F4A	2.375	3 3/32	.055	.090

York also manufactures custom pulleys and complete assemblies
 email: support@york-ind.com web: www.york-ind.com



BLACK NEOPRENE, Fiberglass Cord (RoHS compliant)

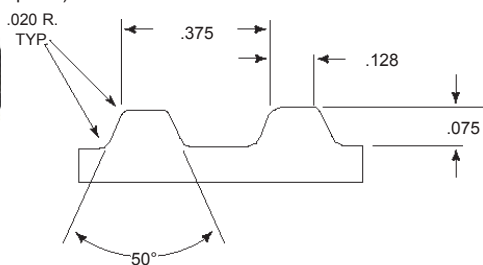

BELT NUMBER	1/2"	WIDTHS 3/4"	1"	PITCH LENGTH	NUMBER OF TEETH
108L	050	075	100	10.875	29
124L	050	075	100	12.38	33
135L	050	075	100	13.50	36
150L	050	075	100	15.00	40
153L	050	075	100	15.38	41
157L	050	075	100	15.75	42
165L	050	075	100	16.50	44
168L	050	075	100	16.88	45
172L	050	075	100	17.25	46
176L	050	075	100	17.63	47
187L	050	075	100	18.75	50
195L	050	075	100	19.50	52
202L	050	075	100	20.25	54
210L	050	075	100	21.00	56
217L	050	075	100	21.75	58
225L	050	075	100	22.50	60
236L	050	075	100	23.63	63
240L	050	075	100	24.00	64
243L	050	075	100	24.38	65
247L	050	075	100	24.75	66
251L	050	075	100	25.13	67
255L	050	075	100	25.50	68
262L	050	075	100	26.25	70
270L	050	075	100	27.00	72
285L	050	075	100	28.50	76
300L	050	075	100	30.00	80
315L	050	075	100	31.50	84
322L	050	075	100	32.25	86
345L	050	075	100	34.50	92

If you don't see the belt you need – call York!

YORK

ISO 9001: 2008 Registered

303 Nassau Blvd., Garden City Park, NY 11040

Tel: 1-800 354 8466 Fax: 1-800 354 8485

BLACK NEOPRENE, Fiberglass Cord (RoHS compliant)

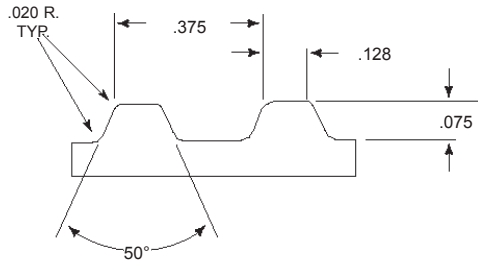

BELT NUMBER	1/2"	WIDTHS 3/4"	1"	PITCH LENGTH	NUMBER OF TEETH
367L	050	075	100	36.75	98
375L	050	075	100	37.50	100
390L	050	075	100	39.00	104
405L	050	075	100	40.50	108
420L	050	075	100	42.00	112
446L	050	075	100	44.63	119
450L	050	075	100	45.00	120
461L	050	075	100	46.13	123
480L	050	075	100	48.00	128
510L	050	075	100	51.00	136
540L	050	075	100	54.00	144
566L	050	075	100	56.63	151
570L	050	075	100	57.00	152
581L	050	075	100	58.13	155
600L	050	075	100	60.00	160
630L	050	075	100	63.00	168
660L	050	075	100	66.00	176
720L	050	075	100	72.00	192
731L	050	075	100	73.13	195
900L	050	075	100	90.00	240
915L	050	075	100	91.50	244
945L	050	075	100	94.50	252

Need a clean, low dust belt? See TruMotion belts.

York also manufactures custom pulleys and complete assemblies
 email: support@york-ind.com web: www.york-ind.com



URETHANE, Polyester Cord (RoHS compliant)

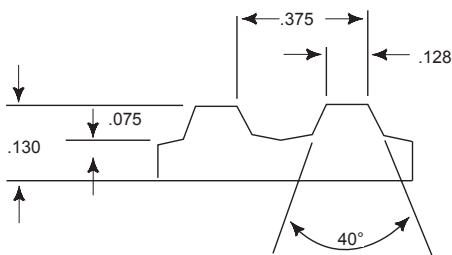

BELT NUMBER	1/2"	WIDTHS 3/4"	1"	PITCH LENGTH	NUMBER OF TEETH
124L-P	050	075	100	12.375	33
150L-P	050	075	100	15.000	40
165L-P	050	075	100	16.500	44
180L-P	050	075	100	18.000	48
187L-P	050	075	100	18.750	50
195L-P	050	075	100	19.500	52
210L-P	050	075	100	21.000	56
225L-P	050	075	100	22.500	60
240L-P	050	075	100	24.000	64
255L-P	050	075	100	25.500	68
270L-P	050	075	100	27.000	72
285L-P	050	075	100	28.500	76
300L-P	050	075	100	30.000	80
315L-P	050	075	100	31.500	84
322L-P	050	075	100	32.250	86
330L-P	050	075	100	33.000	88
345L-P	050	075	100	34.500	92
360L-P	050	075	100	36.000	96
367L-P	050	075	100	36.750	98
375L-P	050	075	100	37.500	100
390L-P	050	075	100	39.000	104
420L-P	050	075	100	42.000	112
450L-P	050	075	100	45.000	120
480L-P	050	075	100	48.000	128

If you don't see the belt you need – call York!

YORK

ISO 9001: 2008 Registered

303 Nassau Blvd., Garden City Park, NY 11040

Tel: 1-800 354 8466 Fax: 1-800 354 8485

URETHANE, Kevlar Cord (RoHS compliant)

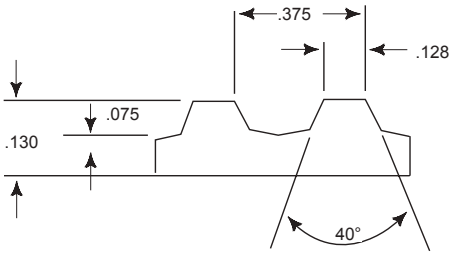

BELT NUMBER	1/2"	WIDTHS 3/4"	1"	PITCH LENGTH	NUMBER OF TEETH
124L-K	050	075	100	12.375	33
150L-K	050	075	100	15.000	40
165L-K	050	075	100	16.500	44
180L-K	050	075	100	18.000	48
187L-K	050	075	100	18.750	50
195L-K	050	075	100	19.500	52
210L-K	050	075	100	21.000	56
225L-K	050	075	100	22.500	60
240L-K	050	075	100	24.000	64
255L-K	050	075	100	25.500	68
270L-K	050	075	100	27.000	72
285L-K	050	075	100	28.500	76
300L-K	050	075	100	30.000	80
315L-K	050	075	100	31.500	84
322L-K	050	075	100	32.250	86
330L-K	050	075	100	33.000	88
345L-K	050	075	100	34.500	92
360L-K	050	075	100	36.000	96
367L-K	050	075	100	36.750	98
375L-K	050	075	100	37.500	100
390L-K	050	075	100	39.000	104
420L-K	050	075	100	42.000	112
450L-K	050	075	100	45.000	120
480L-K	050	075	100	48.000	128

If you don't see the belt you need – call York!

York also manufactures custom pulleys and complete assemblies
 email: support@york-ind.com web: www.york-ind.com



NEOPRENE, Twin Power, Fiberglass Cord (RoHS compliant)

TWIN POWER

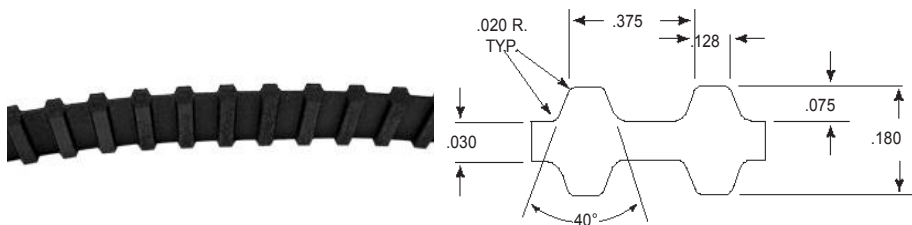

BELT NUMBER	1/2"	WIDTHS 3/4"	1"	PITCH LENGTH	NUMBER OF TEETH
TP150L	050	075	100	15.00	40
TP187L	050	075	100	18.75	50
TP210L	050	075	100	21.00	56
TP225L	050	075	100	22.50	60
TP240L	050	075	100	24.00	64
TP255L	050	075	100	25.50	68
TP270L	050	075	100	27.00	72
TP285L	050	075	100	28.50	76
TP300L	050	075	100	30.00	80
TP322L	050	075	100	32.25	86
TP345L	050	075	100	34.50	92
TP367L	050	075	100	36.75	98
TP390L	050	075	100	39.00	104
TP420L	050	075	100	42.00	112
TP450L	050	075	100	45.00	120
TP480L	050	075	100	48.00	128
TP510L	050	075	100	51.00	136
TP540L	050	075	100	54.00	144
TP600L	050	075	100	60.00	160
TP660L	050	075	100	66.00	176

If you don't see the belt you need – call York!

YORK

ISO 9001: 2008 Registered

303 Nassau Blvd., Garden City Park, NY 11040

Tel: 1-800 354 8466 Fax: 1-800 354 8485

Cream Colored Engineered Polymer with Fiberglass Cord (RoHS compliant)

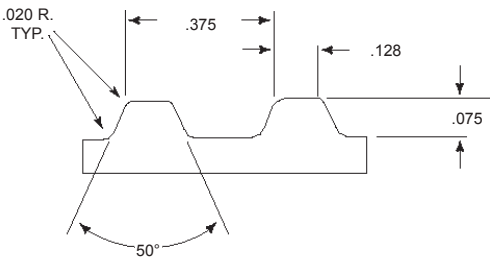

BELT NUMBER	1/2"	WIDTHS 3/4"	1"	PITCH LENGTH	NUMBER OF TEETH
TM-108L	050	075	100	10.875	29
TM-124L	050	075	100	12.38	33
TM-135L	050	075	100	13.50	36
TM-150L	050	075	100	15.00	40
TM-153L	050	075	100	15.38	41
TM-157L	050	075	100	15.75	42
TM-165L	050	075	100	16.50	44
TM-168L	050	075	100	16.88	45
TM-172L	050	075	100	17.25	46
TM-176L	050	075	100	17.63	47
TM-187L	050	075	100	18.75	50
TM-195L	050	075	100	19.50	52
TM-202L	050	075	100	20.25	54
TM-210L	050	075	100	21.00	56
TM-217L	050	075	100	21.75	58
TM-225L	050	075	100	22.50	60
TM-236L	050	075	100	23.63	63
TM-240L	050	075	100	24.00	64
TM-243L	050	075	100	24.38	65
TM-247L	050	075	100	24.75	66
TM-251L	050	075	100	25.13	67
TM-255L	050	075	100	25.50	68
TM-262L	050	075	100	26.25	70
TM-270L	050	075	100	27.00	72
TM-285L	050	075	100	28.50	76
TM-300L	050	075	100	30.00	80
TM-315L	050	075	100	31.50	84
TM-322L	050	075	100	32.25	86
TM-345L	050	075	100	34.50	92

If you don't see the belt you need – call York!

York also manufactures custom pulleys and complete assemblies
 email: support@york-ind.com web: www.york-ind.com



Cream Colored Engineered Polymer with Fiberglass Cord (RoHS compliant)

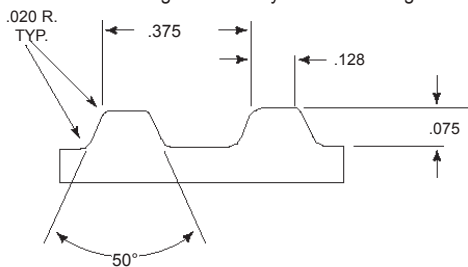

BELT NUMBER	1/2"	WIDTHS 3/4"	1"	PITCH LENGTH	NUMBER OF TEETH
TM-367L	050	075	100	36.75	98
TM-375L	050	075	100	37.50	100
TM-390L	050	075	100	39.00	104
TM-405L	050	075	100	40.50	108
TM-420L	050	075	100	42.00	112
TM-446L	050	075	100	44.63	119
TM-450L	050	075	100	45.00	120
TM-461L	050	075	100	46.13	123
TM-480L	050	075	100	48.00	128
TM-510L	050	075	100	51.00	136
TM-540L	050	075	100	54.00	144
TM-566L	050	075	100	56.63	151
TM-570L	050	075	100	57.00	152
TM-581L	050	075	100	58.13	155
TM-600L	050	075	100	60.00	160
TM-630L	050	075	100	63.00	168
TM-660L	050	075	100	66.00	176
TM-720L	050	075	100	72.00	192
TM-731L	050	075	100	73.13	195
TM-900L	050	075	100	90.00	240
TM-915L	050	075	100	91.50	244
TM-945L	050	075	100	94.50	252

If you don't see the belt you need – call York!

YORK

ISO 9001: 2008 Registered

303 Nassau Blvd., Garden City Park, NY 11040

Tel: 1-800 354 8466 Fax: 1-800 354 8485

ENGINEERING

ENGINEERING

York Industries

Manufacturing to customized specifications, and providing specialized design assistance, fast turnaround at every stage from prototype to production, and award winning quality since 1942.



ENGINEERING

Timing Belt Drives

Tolerances & Specifications

Timing Pulleys - Timing Pulley Stock
Flanges - Belts

Table of Contents

TOLERANCES & SPECIFICATIONS	E2
Timing pulleys, timing pulley stock, flanges	
TOLERANCES & SPECIFICATIONS	E3
Belts	
CENTER DISTANCE CALCULATION	E7
AUTOMATED DRIVE DESIGN SOFTWARE	E8
STANDARD CALCULATIONS	E9
SPECIFICATION FOR DRIVES USING SYNCHRONOUS BELTS	E10
SYNCHRONOUS BELTS	E15
BELT PROFILE AND PITCH SELECTION	E20
BELT MATERIALS AND CONSTRUCTION	E28
TRUMOTION BELTS	E29
SHAFT-SAVER VS STANDARD SET SCREWS	E30
SHAFT-SAVER GRIPPING TORQUE VALUES	E31
TENSIONERS	E32

TOLERANCES & SPECIFICATIONS
 Timing pulleys • timing pulley stock • flanges

TIMING PULLEYS O.D. TOLERANCES

.0816" PITCH (40 D.P.)	+ .000	- .003	
2mm, 3mm, 5mm, .080", 1/5", 3/8" PITCH			
0" – 1.000" O.D.	+ .002	- .000	
1.001" – 2.000" O.D.	+ .003	- .000	
2.001" – 4.000" O.D.	+ .004	- .000	
4.001" – 7.000" O.D.	+ .005	- .000	
7.001" – 12.000" O.D.	+ .006	- .000	
12.001" – 20.000" O.D.	+ .007	- .000	
20.000" AND UP O.D.	+ .008	- .000	

BORE TOLERANCES

0" – 1.000"	+ .001	- .000	
1.001" – 2.000"	+ .0015	- .000	
2.001" – 3.000"	+ .002	- .000	
3.001" AND UP	+ .0025	- .000	

ECCENTRICITY TOLERANCE

(PULLEY BORE TO O.D.)

0" – 8.000"	.004 T.I.R.
8.000" AND UP	.0005 T.I.R. PER INCH OF PULLEY DIA. (NOT TO EXCEED O.D. TOLERANCE)

LATERAL RUN OUT TOLERANCE

.001 T.I.R. PER INCH OF PULLEY DIA. (.020 MAX.)

TIMING PULLEY STOCK O.D. TOLERANCES

.0816" PITCH (40 D.P.)	+ .000	- .003	
2mm, 3mm, 5mm, .080", 1/5", 3/8" PITCH			
0" – 1.000" O.D.	+ .002	- .000	
1.001" – 2.000" O.D.	+ .003	- .000	
2.001" – 4.000" O.D.	+ .004	- .000	
4.000" – 7.000" O.D.	+ .005	- .000	

FLANGE TOLERANCES

PITCH	OVERALL FORMED		
	I.D.	O.D.	THICKNESS
.080	±.003	±.015	±.010
.0816 (40 D.P.)	±.003	±.015	±.010
2mm	±.003	±.015	±.010
3mm	±.003	±.015	±.010
5mm	±.003	±.015	±.010
1/5"	±.003	±.015	±.010
3/8"	±.005	±.015	±.010

TOLERANCES & SPECIFICATIONS BELTS

.080" PITCH

NEOPRENE AND TRUMOTION

BREAKING STRENGTH

425 LBS PER INCH OF BELT WIDTH

TEMPERATURE RANGE

-30°F TO 185°F

WIDTH TOLERANCE

SEE CHART ON PAGE E6

.080" PITCH

URETHANE
POLYESTER CORD

BREAKING STRENGTH

520 LBS. PER INCH OF WIDTH

TEMPERATURE RANGE

0°F TO 180°F

LENGTH TOLERANCE

CENTER DISTANCE TOLERANCE $\pm .020$ "

WIDTH TOLERANCE

$\pm .020$ " FOR BELTS 1/16"- 4" WIDE

.080" PITCH

URETHANE
KEVLAR CORD

BREAKING STRENGTH

1050 LBS. PER INCH OF WIDTH

TEMPERATURE RANGE

0°F TO 180°F

LENGTH TOLERANCE

CENTER DISTANCE TOLERANCE $\pm .020$ "

WIDTH TOLERANCE

$\pm .020$ " FOR BELTS 1/16"- 4" WIDE

.0816" PITCH (40 D.P.)

URETHANE
POLYESTER CORD

BREAKING STRENGTH

520 LBS. PER INCH OF WIDTH

TEMPERATURE RANGE

0°F TO 180°F

LENGTH TOLERANCE

CENTER DISTANCE TOLERANCE $\pm .020$ "

WIDTH TOLERANCE

$\pm .020$ " FOR BELTS 1/16"- 4" WIDE

.0816" PITCH (40 D.P.)

URETHANE
KEVLAR CORD

BREAKING STRENGTH

1050 LBS. PER INCH OF WIDTH

TEMPERATURE RANGE

0°F TO 180°F

LENGTH TOLERANCE

CENTER DISTANCE TOLERANCE $\pm .020$ "

WIDTH TOLERANCE

$\pm .020$ " FOR BELTS 1/16"- 4" WIDE

TOLERANCES & SPECIFICATIONS
BELTS - continued

1/5" PITCH

URETHANE
POLYESTER CORD

BREAKING STRENGTH
630 LBS. PER INCH OF WIDTH

TEMPERATURE RANGE
0°F TO 180°F

LENGTH TOLERANCE
CENTER DISTANCE TOLERANCE ± .020"

WIDTH TOLERANCE
± .020" FOR BELTS 1/16"- 4" WIDE

3/8" PITCH

URETHANE
POLYESTER CORD

BREAKING STRENGTH
630 LBS. PER INCH OF WIDTH

TEMPERATURE RANGE
0°F TO 180°F

LENGTH TOLERANCE
CENTER DISTANCE TOLERANCE ± .020"

WIDTH TOLERANCE
± .020" FOR BELTS 1/16"- 4" WIDE

1/5" PITCH

URETHANE
KEVLAR CORD

BREAKING STRENGTH
2500 LBS. PER INCH OF WIDTH

TEMPERATURE RANGE
0°F TO 180°F

LENGTH TOLERANCE
CENTER DISTANCE TOLERANCE ± .020"

WIDTH TOLERANCE
± .020" FOR BELTS 1/16"- 4" WIDE

3/8" PITCH

URETHANE
KEVLAR CORD

BREAKING STRENGTH
3000 LBS. PER INCH OF WIDTH

TEMPERATURE RANGE
0°F TO 180°F

LENGTH TOLERANCE
CENTER DISTANCE TOLERANCE ± .020"

WIDTH TOLERANCE
± .020" FOR BELTS 1/16"- 4" WIDE

1/5" PITCH

NEOPRENE AND TRUMOTION

BREAKING STRENGTH
895 LBS. PER INCH OF WIDTH

TEMPERATURE RANGE
-30°F TO 185°F

LENGTH TOLERANCE
CENTER DISTANCE TOLERANCE ± .020"

WIDTH TOLERANCE
SEE CHART ON PAGE E6

3/8" PITCH

NEOPRENE AND TRUMOTION

BREAKING STRENGTH
920 LBS. PER INCH OF WIDTH

TEMPERATURE RANGE
-30°F TO 185°F

LENGTH TOLERANCE
CENTER DISTANCE TOLERANCE ± .020"

WIDTH TOLERANCE
SEE CHART ON PAGE E6

TOLERANCES & SPECIFICATIONS

BELTS - continued

3 MM HTD PITCH

NEOPRENE AND
TRUMOTION

BREAKING STRENGTH
920 LBS. PER INCH OF WIDTH

TEMPERATURE RANGE
-30°F TO 185°F

LENGTH TOLERANCE
CENTER DISTANCE TOLERANCE $\pm .020$ "

WIDTH TOLERANCE
SEE CHART ON PAGE E6

2 MM GT2 PITCH

NEOPRENE AND
TRUMOTION

BREAKING STRENGTH
495 LBS. PER INCH OF WIDTH

TEMPERATURE RANGE
-30°F TO 185°F

LENGTH TOLERANCE
CENTER DISTANCE TOLERANCE $\pm .020$ "

WIDTH TOLERANCE
SEE CHART ON PAGE E6

5 MM HTD PITCH

NEOPRENE AND
TRUMOTION

BREAKING STRENGTH
1800 LBS. PER INCH OF WIDTH

TEMPERATURE RANGE
-30°F TO 185°F

LENGTH TOLERANCE
CENTER DISTANCE TOLERANCE $\pm .020$ "

WIDTH TOLERANCE
SEE CHART ON PAGE E6

3 MM GT2 PITCH

NEOPRENE AND
TRUMOTION

BREAKING STRENGTH
880 LBS. PER INCH OF WIDTH

TEMPERATURE RANGE
-30°F TO 185°F

LENGTH TOLERANCE
CENTER DISTANCE TOLERANCE $\pm .020$ "

WIDTH TOLERANCE
SEE CHART ON PAGE E6

TOLERANCES & SPECIFICATIONS BELTS - continued

2mm, 3mm, 5mm, .080", 1/5" - 3/8" PITCH

NEOPRENE AND TRUMOTION BELTS
TEMPERATURE RANGE -30° F TO 185° F

STANDARD TIMING BELT WIDTH TOLERANCES

(FOR NEOPRENE AND TRUMOTION BELTS
2mm, 3mm, 5mm, .080", 1/5" AND 3/8" PITCH)*

BELT WIDTH IN.	WIDTH TOLERANCE ON BELT LENGTHS 0" TO 33"	WIDTH TOLERANCE ON BELT LENGTHS OVER 33" TO 66"	WIDTH TOLERANCE ON BELT LENGTHS OVER 66"
1/8 TO 7/16	+1/64 -1/32	+1/64 -1/32	
OVER 7/16 TO 1-1/2	+1/32 -1/32	+1/32 -3/64	+1/32 -3/64
OVER 1-1/2 TO 2	+1/32 -3/64	+3/64 -3/64	+3/64 -1/16
OVER 2 TO 2-1/2	+3/64 -3/64	+3/64 -1/16	+1/16 -1/16
OVER 2-1/2 TO 3	+3/64 -1/16	+1/16 -1/16	+1/16 -5/64
OVER 3 TO 4	+1/16 -1/16	+1/16 -5/64	+5/64 -5/64
OVER 4	+3/32 -3/32	+3/32 -7/64	+3/32 -1/8

*Over 1/2 in pitch for belts up to and including 4 inches wide, tolerance= ± 3/16 in. for belts over 4 inches wide, tolerance +3/16 - 1/4

STANDARD NEOPRENE AND TRUMOTION TIMING BELT CENTER-DISTANCE TOLERANCES

BELT LENGTH IN.	*TOLERANCE CENTER-DISTANCE IN.
5 TO 10	±.008
OVER 10 TO 15	±.009
OVER 15 TO 20	±.010
OVER 20 TO 30	±.012
OVER 30 TO 40	±.013
OVER 40 TO 50	±.015
OVER 50 TO 60	±.016
OVER 60 TO 70	±.017
OVER 70	ON APPLICATION ADD .001" FOR EVERY 10" SPREAD

*Tolerances are for reference only. Belts measured on 20 groove pulleys under allowable working tensions.

TWIN POWER BELTS 1/5" - 3/8" PITCH

BLACK NEOPRENE FIBREGLOSS CORD
TEMPERATURE RANGE -30° F TO 185° F

TWIN POWER TOLERANCES

Since twin power belts are manufactured and cut to the required width by the same method as standard belts, the same manufacturing tolerances apply, except for the thickness and length tolerances which are shown in the following tables.

BELT THICKNESS TOLERANCES

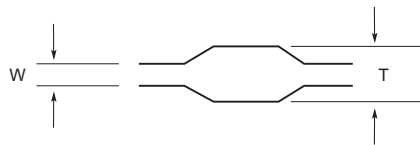

PITCH	T (IN.)	W (IN.)
1/5-INCH (XL)	.120 ± .006	.020 ± .004
3/8-INCH (L)	.180 ± .006	.030 ± .004

CENTER-DISTANCE TOLERANCES

BELT LENGTH IN.	*TOLERANCE CENTER-DISTANCE IN.
15 TO 20	±.020
OVER 20 TO 30	±.024
OVER 30 TO 40	±.026
OVER 40 TO 50	±.030
OVER 50 TO 60	±.032
OVER 60 TO 70	±.034
OVER 70	(REFER TO FACTORY)

CENTER DISTANCE CALCULATION

(Design software such as York Industries free "DriveWorks" program can be used instead of this table)

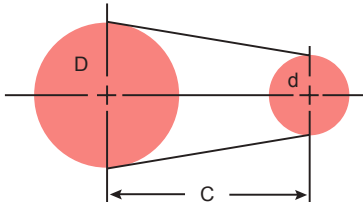

BL = belt length
 D = larger sprocket pitch diameter
 d = Smaller sprocket pitch diameter
 C = Center distance

Equations

$$A = \frac{BL}{2} - .7855 (D+d) \qquad B = \frac{A}{(D-d)} \qquad C = \frac{A}{F^*}$$

*Correction Factor F is given in the table below opposite the appropriate value of B as calculated using the above equations.

Correction Factor (F) Table

B	F	B	F	B	F	B	F	B	F	B	F	B	F
0.7998	1.4286	0.8335	1.3459	0.8826	1.2723	0.9558	1.2063	1.072	1.1468	1.278	1.0929	1.769	1.0438
0.8005	1.4265	0.8344	1.3441	0.8839	1.2706	0.9579	1.2048	1.076	1.1455	1.285	1.0917	1.789	1.0428
0.8011	1.4245	0.8354	1.3423	0.8853	1.2690	0.9601	1.2034	1.079	1.1442	1.291	1.0905	1.810	1.0417
0.8018	1.4225	0.8363	1.3405	0.8867	1.2674	0.9622	1.2019	1.082	1.1429	1.298	1.0893	1.832	1.0406
0.8024	1.4205	0.8372	1.3387	0.8882	1.2658	0.9644	1.2005	1.086	1.1416	1.305	1.0881	1.855	1.0395
0.8031	1.4184	0.8381	1.3369	0.8897	1.2642	0.9666	1.1990	1.090	1.1403	1.312	1.0870	1.879	1.0384
0.8037	1.4164	0.8391	1.3351	0.8911	1.2626	0.9687	1.1976	1.093	1.1390	1.320	1.0858	1.904	1.0373
0.8044	1.4144	0.8402	1.3333	0.8925	1.2610	0.9710	1.1962	1.097	1.1377	1.327	1.0846	1.930	1.0363
0.8051	1.4122	0.8412	1.3316	0.8940	1.2594	0.9733	1.1947	1.101	1.1364	1.335	1.0834	1.956	1.0352
0.8058	1.4104	0.8422	1.3298	0.8955	1.2579	0.9757	1.1933	1.105	1.1351	1.343	1.0823	1.984	1.0341
0.8066	1.4085	0.8432	1.3280	0.8971	1.2563	0.9780	1.1919	1.109	1.1338	1.351	1.0811	2.014	1.0331
0.8073	1.4065	0.8442	1.3263	0.8985	1.2547	0.9803	1.1905	1.113	1.1325	1.360	1.0799	2.045	1.0320
0.8080	1.4045	0.8452	1.3245	0.9000	1.2531	0.9828	1.1891	1.117	1.1312	1.368	1.0787	2.078	1.0309
0.8087	1.4025	0.8463	1.3228	0.9015	1.2516	0.9851	1.1876	1.121	1.1299	1.377	1.0776	2.112	1.0299
0.8094	1.4006	0.8473	1.3210	0.9031	1.2500	0.9875	1.1862	1.125	1.1287	1.386	1.0764	2.148	1.0288
0.8101	1.3986	0.8484	1.3193	0.9047	1.2484	0.9900	1.1848	1.129	1.1274	1.395	1.0753	2.186	1.0277
0.8108	1.3966	0.8495	1.3175	0.9063	1.2469	0.9924	1.1834	1.133	1.1261	1.404	1.0741	2.227	1.0267
0.8116	1.3947	0.8505	1.3158	0.9079	1.2453	0.9949	1.1820	1.138	1.1249	1.413	1.0730	2.270	1.0256
0.8123	1.3928	0.8517	1.3141	0.9095	1.2438	0.9974	1.1806	1.142	1.1236	1.423	1.0718	2.315	1.0246
0.8131	1.3908	0.8529	1.3123	0.9112	1.2422	1.000	1.1792	1.146	1.1223	1.432	1.0707	2.362	1.0235
0.8139	1.3889	0.8540	1.3106	0.9128	1.2407	1.002	1.1779	1.150	1.1211	1.442	1.0695	2.414	1.0225
0.8147	1.3870	0.8551	1.3089	0.9145	1.2392	1.005	1.1765	1.155	1.1198	1.453	1.0684	2.469	1.0215
0.8155	1.3850	0.8563	1.3072	0.9161	1.2376	1.008	1.1751	1.160	1.1186	1.463	1.0672	2.529	1.0204
0.8162	1.3831	0.8574	1.3055	0.9178	1.2361	1.011	1.1737	1.164	1.1173	1.474	1.0661	2.594	1.0194
0.8170	1.3812	0.8585	1.3038	0.9196	1.2346	1.013	1.1723	1.169	1.1161	1.485	1.0650	2.664	1.0183
0.8178	1.3793	0.8597	1.3021	0.9214	1.2330	1.016	1.1710	1.174	1.1148	1.497	1.0638	2.739	1.0173
0.8186	1.3774	0.8609	1.3004	0.9231	1.2315	1.019	1.1696	1.178	1.1136	1.509	1.0627	2.823	1.0163
0.8194	1.3755	0.8621	1.2987	0.9248	1.2300	1.021	1.1682	1.183	1.1123	1.521	1.0616	2.913	1.0152
0.8202	1.3736	0.8633	1.2970	0.9265	1.2285	1.024	1.1669	1.189	1.1111	1.533	1.0604	3.013	1.0142
0.8211	1.3717	0.8645	1.2953	0.9284	1.2270	1.027	1.1655	1.194	1.1099	1.546	1.0593	3.125	1.0132
0.8220	1.3699	0.8657	1.2937	0.9302	1.2255	1.030	1.1641	1.199	1.1086	1.558	1.0582	3.247	1.0121
0.8228	1.3680	0.8669	1.2920	0.9320	1.2240	1.033	1.1628	1.205	1.1074	1.571	1.0571	3.392	1.0111
0.8237	1.3661	0.8682	1.2903	0.9339	1.2225	1.036	1.1614	1.210	1.1062	1.585	1.0560	3.556	1.0101
0.8246	1.3643	0.8695	1.2887	0.9358	1.2210	1.039	1.1601	1.216	1.1050	1.599	1.0549	3.746	1.0091
0.8254	1.3624	0.8707	1.2870	0.9378	1.2195	1.042	1.1587	1.222	1.1038	1.614	1.0537	3.971	1.0081
0.8263	1.3605	0.8719	1.2853	0.9397	1.2180	1.045	1.1574	1.227	1.1025	1.629	1.0526	4.241	1.0070
0.8272	1.3587	0.8732	1.2837	0.9416	1.2165	1.049	1.1561	1.233	1.1013	1.645	1.0515	4.580	1.0060
0.8280	1.3569	0.8745	1.2821	0.9435	1.2151	1.052	1.1547	1.239	1.1001	1.661	1.0504	5.020	1.0050
0.8289	1.3550	0.8759	1.2804	0.9455	1.2136	1.055	1.1534	1.245	1.0989	1.678	1.0493	5.600	1.0040
0.8298	1.3532	0.8772	1.2788	0.9475	1.2121	1.059	1.1521	1.252	1.0977	1.695	1.0482	6.465	1.0030
0.8307	1.3514	0.8785	1.2771	0.9495	1.2107	1.062	1.1507	1.258	1.0965	1.713	1.0471	7.914	1.0020
0.8316	1.3495	0.8799	1.2755	0.9516	1.2092	1.065	1.1494	1.265	1.0953	1.731	1.0460	11.186	1.0010
0.8326	1.3477	0.8812	1.2739	0.9537	1.2077	1.069	1.1481	1.271	1.0941	1.749	1.0449	AND UP	1.0000

York also manufactures custom pulleys and complete assemblies
 email: support@york-ind.com web: www.york-ind.com



AUTOMATED DRIVE DESIGN SOFTWARE DRIVEWORKS2

York Industries offers a free, no obligation automated drive design program, DriveWorks. This Windows based software is meant for two point drive systems. It includes belt sizing, tensioner placement, pulley diameters, and is based on your constraints for where the Drive and Driven pulley centers can be located in your mechanical layout. DriveWorks is an excellent adjunct to CAD systems such as SolidWorks, ProEngineer, and SolidView, among others, since it lets you create and define your drive system offline from your CAD software, yet basing it on the area(s) you have reserved in your mechanical or wireframe model. A sample screenshot is below:

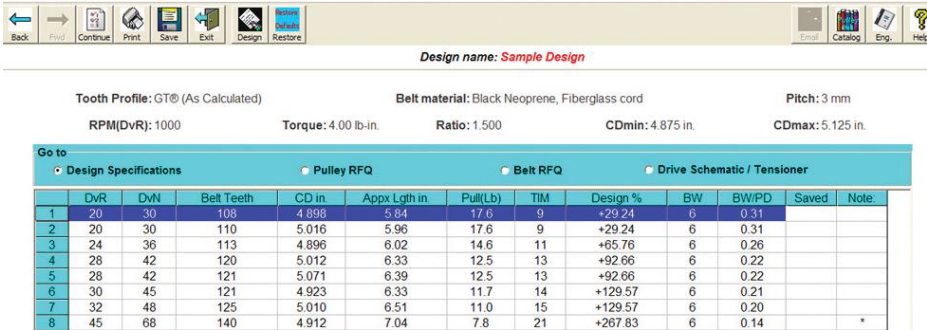

All of the above are valid solutions that meet the mechanical constraints for this design. York has a library of CAD models for all its timing pulleys, belts, and in-stock tensioners. So when you pick the specific solution you want from the range of solutions DriveWorks provides, you can download 2D and 3D CAD models that match that solution and import them into your CAD package. Even IGUS and STEP models are available.

DriveWorks will automatically perform the center distance calculations as shown on the previous page to allow the use of a stock timing belt, if one is available, saving you custom mold charges. Many of the standard calculations that follow this page in the Engineering Data section are also performed automatically in DriveWorks.

DriveWorks enables a drive designer to have expert assistance optimizing the drive system design without having to become an expert themselves. And the results mesh right into almost all CAD system through the use of York's downloadable 3D CAD models.

DriveWorks software is available online at www.york-ind.com/dw_download.htm or you can request a copy be mailed to you at www.york-ind.com/dw_cd.htm And York provides free tech support if you have any questions about using DriveWorks software or developing your drive system design. York's support staff can be contacted at the address or phone number at the bottom of this page.

STANDARD CALCULATIONS

REQUIRED	GIVEN	FORMULA
Speed ratio (R)	Shaft speeds (rpm)	$R = \frac{\text{rpm (faster shaft speed)}}{\text{rpm (slower shaft speed)}}$
	Pulley diameters (D & d)	$R = \frac{D \text{ (larger pulley diameter)}}{d \text{ (smaller pulley diameter)}}$
	Number of pulley grooves (N&n)	$R = \frac{N \text{ (larger pulley groove no.)}}{n \text{ (smaller pulley groove no.)}}$
Horsepower (hp)	Torque (T) in in-lbs Shaft speed (rpm)	$hp = \frac{T \times rpm}{63,025}$
Design horsepower (Dhp)	Rated Horsepower (hp) Service factor (SF)	$Dhp = hp \times SF$
Power (kw)	Horsepower (hp)	$kw = 7457 \times hp$
Torque (T) in in – lbs.	Shaft horsepower (hp) Shaft speed (rpm)	$T = \frac{63,025 \times hp}{rpm}$
Torque (T) in N-mm	Torque (T) in in-lbs	$T = 112.98 \times T$
Peak Torque (T)	Torque (T) Service factor (SF)	$T = T \times SF$
Effective tension (Te) in pounds	Shaft horsepower (hp) Belt speed (BS)	$Te = \frac{33,000 \times hp}{BS}$
	Effective tension (Te) in Newtons	$Te = 2248 \times Te$
Effective tension (Te) in pounds	Torque (T) in in-lbs Pulley pd in inches	$Te = \frac{2 \times T}{pd}$
Effective tension (Te) in Newtons	Torque (T) in N-mm Pulley pd in mm	
Effective tension (Te) in Newtons	Effective tension (Te) in pounds	$Te = 4.4484 \times Te$
Centrifugal tension loss (Tc)	Smaller pulley pd Smaller pulley rpm Tc constant Kc	$Tc = Kc \times pd^2 \times rpm^2$
Allowable working tension (Ta)	Te, Tc & SF	$Ta = (Te + Tc) \times SF$
Service factor (SF)	Belt width Rated Ta for given belt width Calculated Te & Tc	$SF = \frac{\text{Rated } Ta}{Te + Tc}$
Belt speed (BS) in fpm	Pulley pd in inches Pulley speed in rpm	$BS = 262 \times pd \times rpm$
Belt speed (BS) in m/s	Pulley speed in mm Pulley speed in rpm	$BS = .0000524 \times pd \times rpm$
Belt length (BL)	Center distance (C) Pulley diameters (D & d)	$BL = \frac{2C + (D - d)^2}{4C} + 1.57 \times (D + d)$
Arc of contact on smaller pulley (A/Cs)	Pulley diameters (D & d) Center distance (C)	$A/Cs = 180 - \frac{(D - d)}{C} \times 60$

If TIM is less than 6, correct peak torque by value shown in table below.

Teeth in Mesh (TIM) calculations

Determine arc of contact on smaller pulley (A/Cs) using the formula in the above chart. Determine teeth in Mesh (TIM) using the formula below

$$TIM = \frac{A/Cs \times \text{Smaller pulley groove no. (n)}}{360}$$

Drop any fractional part and use only the whole number as any tooth not fully engaged can not be considered a working tooth.

Teeth in Mesh Factor Table	
TM	Design Peak Torque Multiplication Factor
5	1.2
4	1.5
3	2.0
2	Suggest alternate drive
1	Suggest alternate drive

SPECIFICATION FOR DRIVES USING SYNCHRONOUS BELTS

SCOPE.

This standard applies to those belts and pulleys intended for mechanical power transmission, and where positive indexing or synchronous type service may be required.

These specifications cover three standard belt sections which are established on the basis of belt pitch. These sections are designated MXL (0.080 inch pitch), XL (0.200 inch pitch), and L (0.375 inch pitch).

It also covers dimensions for two double sided sections: DXL (0.200 inch pitch), and DL (0.375 inch pitch).

Dimensions of synchronous belts and pulleys together with basic design data are covered in this standard.

Dimensions in customary English units are provided. This standard does not apply to automotive drives for which other standards exist.

SYNCHRONOUS BELT PULLEYS

DIAMETERS.

Table 1 lists the standard pulley diameters by belt section (pitch). Figure 1 defines the pitch, pitch diameter, outside diameter, and the pitch line differential.

WIDTHS.

The standard pulley widths are shown in Table 2 for each belt section. The nominal pulley width is specified in terms of the maximum standard belt width the pulley will accommodate. For example, only one standard nominal width is specified for the XL Belt Section - 0.38 inches. This pulley width can be used for the standard XL belt widths of 0.25 and 0.38 inches.

The actual minimum pulley width, whether flanged or unflanged, is also specified in Table 2 and shown in Figures 2 and 3.

SIZE DESIGNATION.

Pulleys are designated by the number of grooves, the belt section, and a number representing 100 times the nominal width. For example, a 30 groove L section pulley with a nominal width of 0.75 inches would be designated by the number 30L075.

GROOVE PROFILE.

The groove profile is defined as the profile formed by the generating tool rack form described in Table 3 and Figure 4. The sides of the grooves shall be free of surface defects, and the edges of all grooves shall be rounded. The flanks of the grooves shall have a finish of 125 microinches, or better.

FLANGE DIMENSIONS.

The details of suggested pulley flange design are shown in Table 4 and Figure 5.

KEYSEATS.

Keyseats in the hubs of pulleys are shown in Figure 6 and shall conform to the dimensions and tolerances given in Table 5.

BORE TOLERANCES.

Table 6 gives the bore tolerances for belt pulleys.

MISCELLANEOUS TOLERANCES.

Table 7 includes the following miscellaneous pulley tolerances: Outside Diameter, Radial Runout, Axial Runout, Pitch Accuracy.

Table 1 Standard Pulley Diameters – Inches

No. of Grooves	BELT SELECTION					
	MXL (0.080)		XL (0.200)		L (0.375)	
	Diameters		Diameters		Diameters	
	Pitch	Outside	Pitch	Outside	Pitch	Outside
10	0.255	0.235	0.637	0.617	1.194*	1.164*
12	0.306	0.286	0.764	0.744	1.432*	1.402*
14	0.357	0.337	0.891	0.871	1.671	1.641
16	0.407	0.387	1.019	0.999	1.910	1.880
18	0.458	0.438	1.146	1.126	2.149	2.119
20	0.509	0.489	1.273	1.253	2.387	2.357
22	0.560	0.540	1.401	1.381	2.626	2.596
24	0.611	0.591	1.528	1.508	2.865	2.835
26	0.662	0.642	1.783	1.763	3.104	3.074
28	0.713	0.693	1.783	1.763	3.342	3.312
30	0.764	0.744	1.910	1.890	3.581	3.551
32	0.815	0.795	2.037	2.017	3.820	3.790
34	0.866	0.846				
36	0.917	0.897	2.292	2.272	4.297	4.267
40	1.019	0.999	2.546	2.526	4.775	4.745
42	1.070	1.050	2.674	2.654		
44	1.120	1.100	2.801	2.781	5.252	5.222
48	1.222	1.202	3.056	3.036	5.730	5.700
60	1.528	1.508	3.820	3.800	7.162	7.132
72	1.833	1.813	4.584	4.564	8.594	8.564
84					10.027	9.997

*Usually not available in all widths - consult YORK

Figure 1 Pulley Dimensions

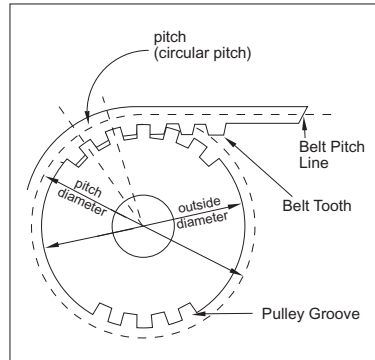

Figure 2 Flanged Pulley

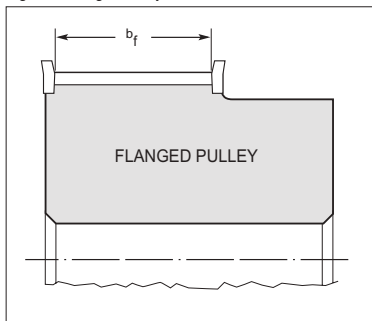

Figure 3 Unflanged Pulley

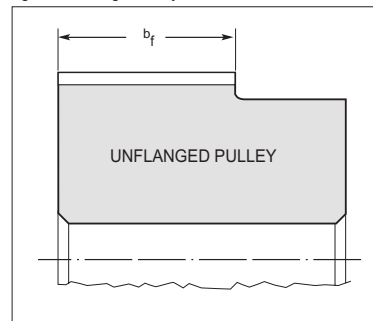

Table 2 Standard Pulley Widths – Inches (See Figures 2 & 3)

BELT SELECTION	STANDARD NOMINAL PULLEY WIDTH	STANDARD PULLEY WIDTH DESIGNATION	MINIMUM PULLEY WIDTH	
			FLANGED b_f	UNFLANGED b_f
MXL (0.080)	0.25	025	0.28	0.35
XL (0.200)	0.38	037	0.41	0.48
L (0.375)	0.50	050	0.55	0.67
	0.75	075	0.80	0.92
	1.00	100	1.05	1.17

York also manufactures custom pulleys and complete assemblies
 email:support@york-ind.com web: www.york-ind.com



Table 3 Pulley Generating Tool Rack Form Dimensions – Inches (See Figures 1 & 4)

BELT SELECTION	NUMBER OF GROOVES	P_b ± 0.0001	β ± 0.25 (Degrees)	h_r $+0.002$ -0.000	b_g $+0.002$ -0.000	r_1 ± 0.001	r_2 ± 0.001	2a
MXL	10 thru 23 24 & over	0.0800	56 40	0.025	0.024 0.265	0.012	0.009	0.020
XL	10 & over	0.2000	50	0.055	0.050	0.024	0.024	0.020
L	10 & over	0.3750	40	0.084	0.122	0.034	0.021	0.030

Figure 4 Pulley Generating Tool Rack Form

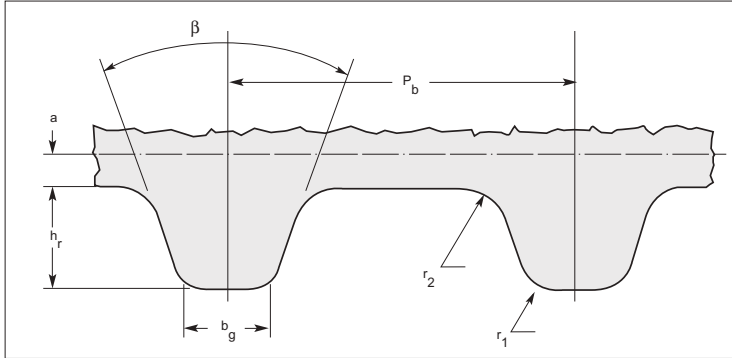

Table 4 Flange Dimensions – Inches (See Figure 5)

BELT SELECTION	MINIMUM FLANGE THICKNESS	MINIMUM FLANGE HEIGHT*
MXL (0.080)	0.023	0.020
XL (0.200)	0.029	0.040
L (0.375)	0.050	0.065

*Flange outside diameter equals pulley outside diameter plus twice flange height.

Figure 5 Flange Dimensions

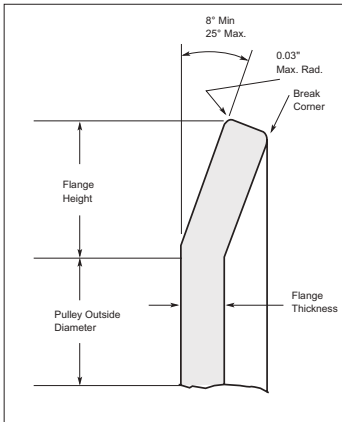

Figure 6 Keyseat Dimensions

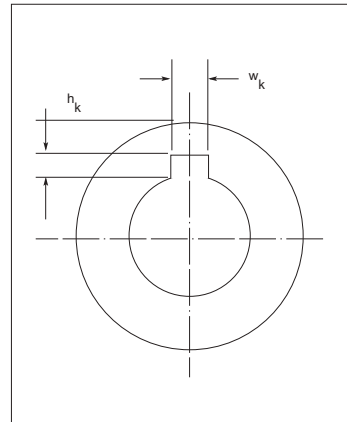

Table 5 Standard Hub Keyseat dimensions – Inches (See Figure 6)

SHAFT DIAMETER		WIDTH, w_k^*	DEPTH, w_k^* + 0.015 -0.000
Up Through 7/16 (0.44)		3/32 (0.094)	3/64 (0.047)
Over 7/16 (0.44) To and Incl	9/16 (0.56)	1/8 (0.125)	1/16 (0.062)
Over 9/16 (0.56) To and Incl	7/8 (0.88)	3/16 (0.188)	3/32 (0.094)
Over 7/8 (0.88) To and Incl	1-1/4 (1.25)	1/4 (0.250)	1/8 (0.125)
Over 1-1/4 (1.25) To and Incl	1-3/8 (1.38)	5/16 (0.312)	5/32 (0.156)
Over 1-3/8 (1.38) To and Incl	1-3/4 (1.75)	3/8 (0.375)	3/16 (0.188)
Over 1-3/4 (1.75) To and Incl	2-1/4 (2.25)	1/2 (0.500)	1/4 (0.250)
Over 2-1/4 (2.25) To and Incl	2-3/4 (2.75)	5/8 (0.625)	5/16 (0.312)
Over 2-3/4 (2.75) To and Incl	3-1/4 (3.25)	3/4 (0.750)	3/8 (0.375)
Over 3-1/4 (3.25) To and Incl	3-3/4 (3.75)	7/8 (0.875)	7/16 (0.438)
Over 3-3/4 (3.75) To and Incl	4-1/2 (4.50)	1 (1.000)	1/2 (0.500)
Over 4-1/2 (4.50) To and Incl	5-1/2 (5.50)	1-1/4 (1.250)	5/8 (0.625)

*Tolerance on width, w_k
 For width up through 1/2 (0.500).....+0.002, -0.000 inches
 For width over 1/2 (0.500)
 up through 1 (1.000).....+0.003, -0.000 inches
 For width over 1 (1.000).....+0.004, -0.000 inches

Table 6 Pulley Bore Tolerances — Inches

DIAMETER OF BORE	LENGTH OF BORE											
	Up Thru 0.75	Over 0.75 To And Including 1.00	Over 1.00 To And Including 1.25	Over 1.25 To And Including 1.50	Over 1.50 To And Including 2.00	Over 2.00 To And Including 2.50	Over 2.50 To And Including 3.00	Over 3.00 To And Including 3.50	Over 3.50 To And Including 4.00	Over 4.00 To And Including 4.50	Over 4.50 To And Including 5.50	Over 5.50 To And Including 6.00
Up thru 0.50	+0.0015 +0.0005	+0.0015 +0.0005	+0.0015 +0.0005	+0.0015 +0.0005	+0.0015 +0.0005							
Over 0.50 To And Including 1.00	+0.0015 +0.0005	+0.0015 +0.0005	+0.0015 +0.0005	+0.0015 +0.0005	+0.0020 +0.0005	+0.0020 +0.0005	+0.0020 +0.0005					
Over 1.00 To And Including 1.50		+0.0015 +0.0005	+0.0015 +0.0005	+0.0015 +0.0005	+0.0020 +0.0010	+0.0020 +0.0010	+0.0020 +0.0010	+0.0020 +0.0010				
Over 1.50 To And Including 2.00			+0.0020 +0.0005	+0.0020 +0.0005	+0.0025 +0.0010	+0.0025 +0.0010	+0.0025 +0.0010	+0.0025 +0.0010	+0.0030 +0.0010	+0.0030 +0.0010	+0.0030 +0.0010	
Over 2.00 To And Including 2.50				+0.0020 +0.0005	+0.0025 +0.0010	+0.0025 +0.0010	+0.0025 +0.0010	+0.0025 +0.0010	+0.0030 +0.0010	+0.0030 +0.0010	+0.0030 +0.0010	
Over 2.50 To And Including 3.00					+0.0025 +0.0010	+0.0025 +0.0010	+0.0025 +0.0010	+0.0025 +0.0010	+0.0030 +0.0010	+0.0030 +0.0010	+0.0035 +0.0015	
Over 3.00 To And Including 3.50					+0.0030 +0.0010	+0.0030 +0.0010	+0.0030 +0.0010	+0.0030 +0.0010	+0.0035 +0.0010	+0.0035 +0.0010	+0.0040 +0.0015	
Over 3.50 To And Including 4.00						+0.0030 +0.0010	+0.0030 +0.0010	+0.0030 +0.0010	+0.0040 +0.0015	+0.0040 +0.0015	+0.0040 +0.0015	
Over 4.00 To And Including 4.50							+0.0030 +0.0010	+0.0030 +0.0010	+0.0040 +0.0015	+0.0040 +0.0015	+0.0040 +0.0015	
Over 4.50 To And Including 5.00							+0.0030 +0.0010	+0.0030 +0.0010	+0.0040 +0.0015	+0.0040 +0.0015	+0.0040 +0.0015	



Table 7 Miscellaneous Pulley Tolerances – Inches (All Sections)

OUTSIDE DIAMETER RANGE	OUTSIDE DIAMETER TOLERANCE	PITCH TO PITCH TOLERANCE	
		ADJACENT GROOVES	ACCUMULATIVE OVER 90 DEGREES
Up Thru 1.000	+0.002 -0.000	±0.001	±0.003
Over 1.000 To And Including 2.000	+0.003 -0.000	±0.001	±0.004
Over 2.000 To And Including 4.000	+0.004 -0.000	±0.001	±0.005
Over 4.000 To And Including 7.000	+0.005 -0.000	±0.001	±0.005
Over 7.000 To And Including 12.000	+0.006 -0.000	±0.001	±0.006
Over 12.000 To And Including 20.000	+0.007 -0.000	±0.001	±0.007
Over 20.000	+0.008 -0.000	±0.001	±0.008

Other Pulley Tolerances

RADIAL RUNOUT*

For outside diameters 8.0 inches and under0.005 inches
 For each additional inch of outside diameter add.....0.0005 inches

AXIAL RUNOUT*

For outside diameters 1.0 inches and under.....0.001 inches
 For each additional inch of outside diameter up through 10.0 inches, add.....0.001 inches
 For each additional inch of outside diameter over 10.0 inches, add.....0.0005 inches

*Total Indicator Reading

SYNCHRONOUS BELTS

SIZE DESIGNATIONS.

Synchronous Belt sizes are identified by a standard number. The first digits specify the belt length to one-tenth inch followed by the belt section (pitch) designation. The digits following the belt section designation represent the nominal belt width times 100. For example, an L section belt 30.000 inches in pitch length and 0.75 inches in width would be specified as a 300L075 Synchronous Belt. The nomenclature for double-sided belts will be the same as for single-sided belts with the addition of the prefix "D" in front of the belt section – Example 300DL075.

STANDARD SECTIONS.

Belt sections are specified in terms of "pitch". Table 8 gives the Standard Belt Sections and their corresponding "pitch"

NOMINAL TOOTH DIMENSIONS.

Table 9 and Figure 7 show the nominal tooth dimensions for each of the standard belt sections. The tooth dimensions for double-sided belts are identical to those of a single-sided belt.

PITCH LENGTHS.

Standard belt pitch lengths, belt length designations and numbers of teeth are shown in Table 10.

WIDTHS.

Standard belt widths and width designations are shown in Table 11.

Table 8 Standard Belt Sections – Inches (See Figure 7)

BELT SELECTION	PITCH	h_g	h_d
MXL	0.080	0.045	
XL	0.200	0.090	
L	0.375	0.14	
DXL	0.200	0.120	0.120
DL	0.375	0.180	0.180

Table 9 Nominal Tooth Dimensions – Inches (See Figure 7)

BELT SELECTION	SS TOOTH ANGLE (DEGREES)	h_t	b_t	r_a	r_r
MXL (0.080)	40	0.020	0.045	0.005	0.005
XL (0.200)	50	0.050	0.101	0.015	0.015
L (0.375)	40	0.075	0.183	0.020	0.020
DXL (0.200)	40	0.050	0.101	0.015	0.015
DL (0.375)	40	0.075	0.183	0.020	0.020

Figure 7 Tooth Dimensions

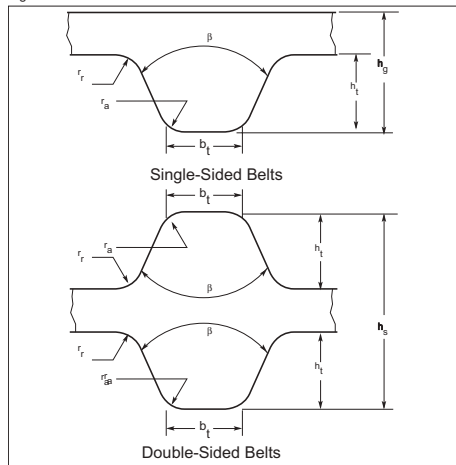

Table 10 Standard Pitch Lengths and Tolerances – Inches

BELT LENGTH DESIGNATION	PITCH LENGTH	PERMISSIBLE DEVIATION FROM STANDARD LENGTH	NUMBER OF TEETH FOR STANDARD LENGTHS		
			MXL (0.080)	XL (0.200)	L (0.375)
36	3.600	±0.016	45		
40	4.000	±0.016	50		
44	4.400	±0.016	55		
48	4.800	±0.016	60		
56	5.600	±0.016	70		
60	6.000	±0.016	75	30	
64	6.400	±0.016	80		
70	7.000	±0.016		35	
72	7.200	±0.016	90		
80	8.000	±0.016	100	40	
88	8.800	±0.016	110		
90	9.000	±0.016		45	
100	10.000	±0.016	125	50	
110	11.000	±0.018		55	
112	11.200	±0.018	140		
120	12.000	±0.018		60	
124	12.375	±0.018			33
124	12.400	±0.018	155		
130	13.000	±0.018		65	
140	14.000	±0.018	175	70	
150	15.000	±0.018		75	40
160	16.000	±0.020	200	80	
170	17.000	±0.020		85	
180	18.000	±0.020	225	90	
187	18.750	±0.020			50
190	19.000	±0.020		95	
200	20.000	±0.020	250	100	
210	21.000	±0.024		105	56
220	22.000	±0.024		110	
225	22.500	±0.024			60
230	23.000	±0.024		115	
240	24.000	±0.024		120	64
250	25.000	±0.024		125	
255	25.500	±0.024			68
260	26.000	±0.024		130	
270	27.000	±0.024			72
285	28.500	±0.024			76
300	30.000	±0.024			80
322	32.250	±0.026			86
345	34.500	±0.026			92
367	36.750	±0.026			98
390	39.000	±0.026			104
420	42.000	±0.030			112
450	45.000	±0.030			120
480	48.000	±0.030			128
510	51.000	±0.032			136
540	54.000	±0.032			144
570	57.000	±0.032			160

SYNCHRONOUS BELTS (CONT'D)

LENGTH TOLERANCES.

The belt length tolerances shown in Table 10 apply to all belt sections and represent the total manufacturing tolerance on the belt length. For fixed center drives consult the belt manufacturer.

WIDTH TOLERANCE.

Belt width tolerances for all belt sections are given in Table 11.

LENGTH DETERMINATION.

The pitch length of a belt shall be determined by placing the belt on a measuring fixture comprising two pulleys of equal diameter, a method of applying force and a means of measuring the center distance between the two pulleys.

One of the two pulleys is fixed in position while the other is movable along a graduated scale. Recommended measuring pulley dimensions are shown in Table 12.

The fixture is shown schematically in Figure 9. Any pair of equal diameter pulleys of the proper pitch and manufactured to the specifications shown in the "Synchronous Belt Pulleys" section may be used for measuring provided the clearance between the theoretical belt tooth width and the groove width of the measuring pulley is not less than the minimum values shown in Table 12. Measuring forces for the standard belt sections and widths are shown in Table 13.

In measuring the length of a belt, the belt should be rotated at least two revolutions of the belt in order to (a) seat the belt properly in the pulley grooves, (b) divide equally the total force between the two strands of the belt, and (c) determine the midpoint of the center distance travel of the movable pulley which shall define the center distance.

The pitch length shall be calculated by adding the pitch circumference of one of the measuring pulleys to twice the measured center distance between the two pulleys.

Table 11 Standard Belt Widths and Tolerances – Inches

BELT SELECTION	STANDARD BELT WIDTHS		TOLERANCES ON WIDTH FOR BELT PITCH LENGTHS	
	DESIGNATION	DEMENSIONS	UP TO AND INCLUDING 33 INCHES	OVER 33 INCHES UP TO AND INCLUDING 66 INCHES
MXL (0.080)	012	0.12	+0.02	-
	019	0.19	-0.03	
	025	0.25		
XL (0.200)	025	0.25	+0.02	-
	037	0.38	-0.03	
L (0.375)	050	0.50	+0.03	+0.03
	075	0.75	-0.03	-0.05
	100	1.00		

Figure 8 Measuring Pulley & Belt

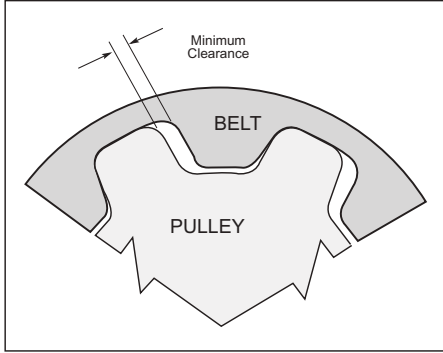

Figure 9 Measuring Pitch Length

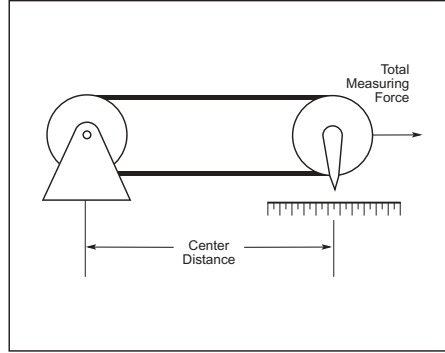

Table 12 Belt Length Measuring Pulleys – Inches

BELT SELECTION	NUMBER OF TEETH	PITCH CIRCUMFERENCE	OUTSIDE DIAMETER	RADIAL RUNOUT T.I.R.*	AXIAL RUNOUT T.I.R.*	MINIMUM CLEARANCE (SEE FIG. 8)
MXL (0.080)	20	1.600	0.4893 ±0.0005	0.0005	0.001	0.010
XL (0.200)	10	2.000	0.6166 ±0.0005	0.0005	0.001	0.012
L (0.375)	16	6.000	1.8799 ±0.0005	0.0005	0.001	0.013

* Total Indicator Reading (Maximum)

Table 13 Total Measuring Force – Pounds Force (lbf)

BELT SELECTION	BELT WIDTH (INCHES)						
	0.12	0.19	0.25	0.38	0.50	0.75	1.00
MXL (0.080)	3	4.5	6				
XL (0.200)			8	12			
L (0.375)					24	40	55

Table 14 Suggested Service Factors For Synchronous Belt Drives)

TYPES OF DRIVEN MACHINES	TYPES OF DRIVING UNITS					
	AC Motors; Normal Torque, Squirrel Cage, Synchronous & Split Phase. DC Motors; Shunt Wound, Multiple Cylinder Internal Combustion Engines.			AC Motors; High Torque, High Slip, Repulsion - Induction, Single Phase Series Wound & Slip Ring, DC Motors; Series Wound & Compound Wound, Single Cylinder Internal Combustion Engines. Line Shafts, Clutches.		
	Service (3-5 Hours Daily or Seasonal)	Normal Service (8-10 Hours Daily)	Continuous Service (16-24 Hours Daily)	Intermittant Service (3-5 Hours Daily or Seasonal)	Normal Service (8-10 Hours Daily)	Continuous Service (16-24 Hours Daily)
Display Equipment Dispensing Equipment Instrumentation Projection Equipment Measuring Devices Medical Equipment	1.0	1.2	1.4	1.2	1.4	1.6
Appliances, Sweepers, Sewing Machines Office Equipment Wood Lathes, Band Saws	1.2	1.4	1.6	1.4	1.6	1.8
Conveyors: Belt, Light Package, Oven, Screens, Drums, Conical	1.3	1.5	1.7	1.5	1.7	1.9
Agitators for Liquids Dough Mixers Drill Press, Lathes, Screw Machines, Jointers, Circular Saws, Planers Laundry Machinery Paper Machinery (except pulpers) Printing Machinery	1.4	1.6	1.8	1.6	1.8	2.0
Agitators for semi - liquids Brick Machinery (except Pug Mills) Conveyor Belt: ore coal, sand Line Shafts Machine Tools: Grinder, Shaper, Boring Mill, Milling Machines Pumps: centrifugal, gear, rotary pipeline Screens: vibrating cam type Textile: warpers, reels Compressor: centrifugal	1.5	1.7	1.9	1.7	1.9	2.1
Conveyor: apron, pan, bucket, elevator Extractors, Washers Fans, Blowers; centrifugal, induced draft exhausters Generators & Exciters Hoists, Elevators Rubber Calender, Mills, Extruders Saw Mill Machinery Textile Machinery: looms, spinning frames, twisters	1.6	1.8	2.0	1.8	2.0	2.2
Centrifuges Conveyors: flight, screw Hammer Mills Paper Pulpers	1.7	1.9	2.1	1.9	2.1	2.3
Brick & Clay Pug Mills Fans, Blowers, Propeller Mine Fans, Positive Blowers	1.8	2.0	2.2	2.0	2.2	2.4

York also manufactures custom pulleys and complete assemblies
 email:support@york-ind.com web: www.york-ind.com



BELT PROFILE AND PITCH SELECTION

A belt 'profile' refers to the shape of the belt tooth when viewed from the side, just like a 'profile' portrait of a person. This two dimensional view will show the belt in a flat position and not curved around a pulley. The shape of the teeth, including how they blend into the belt and the thickness of the belt itself, are all part of the profile. When individual teeth are attached to a belt, the distance from tooth to tooth is the 'pitch' of the belt. For example, a 2 mm GT2 belt will have a tooth every 2 millimeters and each tooth has a GT2 profile.

The pulley that a belt mates with needs to have the same profile and pitch as the belt itself. Pulley profiles are generally mirror images (inverses) of the belt profile since they must mate together. But the pulley version of the profile will have small modifications to ease the plastic belt's entry and exit into the metal grooves of the pulley.

There are two general types of belt profiles, trapezoidal and curvilinear. Older belt profiles were defined and approved by the Mechanical Power Transmission Association in the mid Twentieth Century and are still industry standards today. These are trapezoidal in shape and are heavily used in the power transmission industry since they are standards that have been in use for decades. The other types of profiles are curvilinear and these tend to be proprietary designs. Curvilinear profiles take advantage of advances in machine tools and computers to optimize the profiles beyond those of trapezoidal designs. Curvilinear profiles generally provide increased horsepower, decreased noise, and reduced tooth wear. Whatever belt profile and pitch is used, the pulley must also use the mating version of the same profile at the same pitch.

Choosing a profile for a synchronous drive design is not only determined by horsepower.

Modern belts with fiberglass, polyester and Kevlar cord can generally handle far more horsepower than the drive system requires. And they are strong enough that belt breakage is rarely seen but rather 'cogging' where a belt will hop over one or more teeth on one of the pulleys rather than engage. This is solved with either a wider belt of the same profile or a profile that can provide more horsepower for the same belt width. It can also be solved by changing the pitch since the greater the pitch, the larger the tooth and the more load each tooth can carry. For example, in moving from a 2 mm pitch to a 3 mm pitch, while the space between teeth increases only 50%, the load carrying capacity of each tooth can increase from 6 to 10 times since the cross sectional area and load bearing surface increases dramatically. The trade-off is that you need¹ enough teeth in mesh with the pulleys to prevent cogging or skipping of the belt under load. So for equivalent loads, smaller pulley diameters require smaller pitches while larger pitches can be used if you have the available real estate in your design to handle larger diameter pulleys. The presence of cogging indicates that there is a problem with the drive system. The order to troubleshoot a cogging system would be:

- Is the belt properly installed and tensioned?
- Are the teeth in mesh adequate for the load?
- Is there a large shock load present or is it a reversing drive? (these conditions are the most demanding on a drive system)
- Finally, is the belt pitch and belt width adequate for the load on the system?

The last three solutions require changes to the design while the first solution (proper tension and installation) is a training and installation issue.

So since belt horsepower capacity isn't generally the limiting factor, the consideration is often what profiles are being used by the suppliers of available components or profiles that your company already has parts in inventory to support. For example, if you need a particularly long belt, you would want to try to find one that was a stock product to avoid a custom tooling charge and whatever profile that length was available in would then become the profile for your design. Or if you have special needs such as low noise or low tooth wear, you would look at curvilinear profiles rather than trapezoidal ones. The following charts show the rated torque for a number of belt profiles across various speed and horsepower settings for the same timing pulley diameters and belt widths. In this apples-to-apples comparison, you can see that there is generally a wide overlap among belt profiles in their ability to handle equivalent loads, especially at lower speeds and power.

When you do choose a profile you can get specific engineering data for your particular application and belt profiles using a computer design tool such as York Industries' free DriveWorks software.

This tool provides data such as static tension on the belt, belt deflection, teeth in mesh, and percent of actual load to design load that the specific drive design you have chosen actually delivers. This is ideal for design files required by ISO-9001 or FDA requirements since the software prints out all the information in a format that documents the specific system parameters in a way that allows easy comparison between different profiles or designs and then serves as documentation for why the final design was chosen. It is also an excellent way to avoid grossly overdesigning the drive system, which is easy to do given the capabilities of today's belts and the time and difficulty of manually calculating what DriveWorks can provide in seconds.

In summary, profile and pitch selection is a tradeoff between what component manufacturers offer on their products that you have to include in your design, parts that your company might already stock or have experience with, and the power transmission and space requirements of your design. The wide overlap in load carrying capacity between profiles and pitches generally provides multiple pitch and profile options for the drive designer.

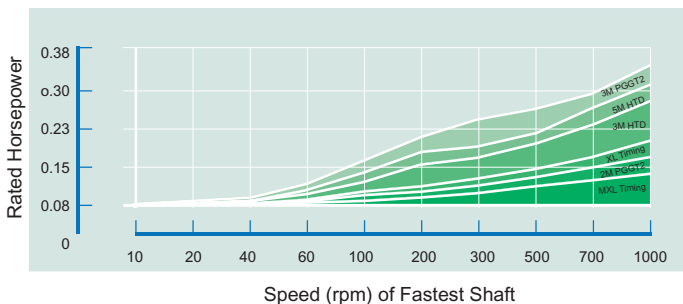
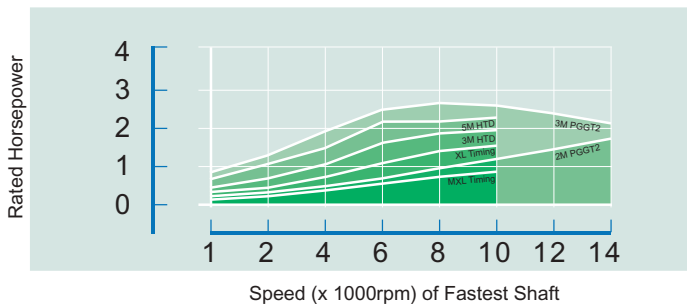

HORSEPOWER AND TORQUE RATING FORMULAS

TORQUE RATINGS.

It is customary to use torque load requirements rather than horsepower load when designing drives using the small pitch MXL section belts. Torque ratings are shown in Table 18 for each standard belt width. Since these belts operate on small diameters resulting in relatively low belt speeds, torque is essentially constant for all rpms. These ratings are based on the adjacent formulas:

TEETH IN MESH FACTOR.

The horsepower or torque ratings from Tables 18, 19, and 20 must be corrected for excessive tooth loading if there are less than 6 teeth in mesh between the belt and the pulley. Determine the proper factor K_z from the following Table 15 to correct for teeth in mesh.

NOMINAL TOOTH DIMENSIONS.

Table 9 and Figure 7 show the nominal tooth dimensions for each of the standard belt sections. The tooth dimensions for double-sided belts are identical to those of a single-sided belt.

HORSEPOWER RATINGS.

Horsepower ratings are used for belt sections MXL, XL and L. These ratings are for the widest standard belt*. To obtain the horsepower rating for other belt widths, multiply the horsepower rating by the appropriate factor shown in Table 16. The horsepower ratings (Tables 18, 19, and 20) are based on the following formulas:

*Total horsepower ratings for double-sided belts are the same as single-sided belts. Contact York Engineering for percent of horsepower available for each side of the belt.

Torque Rating Formulas

BELT SELECTION	BELT WIDTH, INCHES	FORMULA
MXL (0.080)	0.12 0.19 0.25	$Q_r = d (1.13 - 1.38 \times 10^3 d^2)$ $Q_r = d (1.88 - 2.30 \times 10^3 d^2)$ $Q_r = d (2.63 - 3.21 \times 10^3 d^2)$

where: Q_r = The maximum torque rating (lbf-inches) for a belt of specified width having six or more teeth in mesh and a pulley surface speed of 6500 feet/minute or less.
Torque ratings for drives with less than six teeth in mesh must be corrected as shown in Table 15, Teeth in Mesh Factor.
 d = Pitch diameter of smaller pulley, inches.

Table 15 Teeth in Mesh Factor

TEETH IN MESH	FACTOR K_z
6 or more	1.00
5	0.80
4	0.60
3	0.40
2	0.20

The teeth in mesh may be calculated with the following formula:
Teeth in Mesh = $[0.5 - (D-d/6C)]z_1$
where D = pitch diameter, large pulley, inches
 d = pitch diameter, small pulley, inches
 C = center distance between shafts, inches
 z_1 = number of grooves in small pulley

FINDING THE REQUIRED BELT WIDTH

Caution: Belt width should not exceed pulley diameter or excessive side thrust will result.

Horsepower Rating Formulas

BELT SELECTION	BELT WIDTH, INCHES	FORMULAS
XL (0.200)	0.38	$Pr = dr [0.0916 - 7.07 \times 10^5 (dr)^2]$
L (0.375)	1.00	$Pr = dr [0.436 - 3.01 \times 10^4 (dr)^2]$

where: Pr = The maximum horsepower rating recommended for the specified standard belt width having six or more teeth in mesh and a pulley surface speed of 6500 feet/minute or less.

Horsepower ratings for drives with less than six teeth in mesh must be corrected as shown in Table 15. Teeth in Mesh Factor.

d = Pitch diameter of smaller pulley, inches.

r = rpm of faster shaft divided by 1000.

*Total horsepower ratings for double-sided belts are the same as single-sided belts. Contact individual manufacturers for percent of horsepower available for each side of the belt.

The tables of torque and horsepower ratings can be used to find the belt width required for a given application. Use the following procedures for each type of rating method.

TORQUE RATING METHOD. (MXL SECTION)

Determine the required belt width as follows:

- Divide the design torque by the teeth in mesh factor to obtain the corrected design torque.
- Compare the corrected design torque with the torque ratings given in Table 18 for the pulley diameter being considered. Select the narrowest belt width which has a torque rating equal to or greater than the corrected design torque.

HORSEPOWER RATING METHOD (XL and L SECTIONS)

Determine the required belt width as follows:

- Multiply the horsepower rating for the widest standard belt of the section you have selected by the teeth in mesh factor to obtain the corrected horsepower rating. The horsepower ratings are given in Tables 19 and 20.
- Divide the design horsepower by the corrected horsepower rating to obtain the required belt width factor.
- Compare the required belt width factor with those shown in Table 16. Select the narrowest belt width which has a width factor equal to or greater than the required belt width factor.

MAXIMUM PULLEY SURFACE SPEED.

Synchronous Belt Drives are designed to operate at pulley surface speeds up to 6500 feet per minute. Special drives are required for operation in excess of 6500 feet per minute. Where vibration is a critical factor, dynamic balancing of pulleys is recommended regardless of the operating speed.

MINIMUM PULLEY SIZE

The recommended minimum pulley size depends on the rpm of the faster shaft. Table 17 gives the minimum number of grooves for common electric motor speeds.

SELECTION OF FLANGED PULLEYS.

To determine when to use flanged pulleys the following conditions should be considered:

1. On all two pulley drives the minimum flanging requirements are two flanges on one pulley, or one flange on each pulley on opposite sides.
2. On drives where the center distance is more than eight times the diameter of the small pulley, both pulleys should be flanged on both sides.
3. On vertical shaft drives, one pulley should be flanged on both sides and all other pulleys in the system should be flanged on the bottom side only.
4. On drives with more than two pulleys, the minimum flanging requirements are two flanges on every other pulley, or one flange on every pulley, alternating sides around the system.

RECOMMENDED USE OF IDLERS.

The use of idlers should be restricted to those cases in which they are functionally necessary. The usual cases are:

- (a) As a means of applying tension when centers are not adjustable.
- (b) To increase the number of teeth in mesh on the small pulley of relatively high ratio drives.

Idlers should be located on the slack side of the belt. For inside idlers, grooved pulleys are recommended up to 40 grooves. On larger diameters, flat, uncrowned pulleys may be used. Outside idlers should be flat, uncrowned pulleys. Idler diameters should not be smaller than the smallest pulley diameter in the system and idler arc of contact should be held to a minimum. Fixed idlers are recommended.

Table 16 Belt Width Factor

BELT SELECTION	BELT WIDTH (INCHES)						
	0.12	0.19	0.25	0.38	0.50	0.75	1.00
MXL (0.080)	0.43	0.73	1.00				
XL (0.200)			0.62	1.00			
L (0.375)					0.45	0.72	1.00

Table 17 Minimum Number of Grooves

RPM OF FASTER SHAFT	BELT SECTION AND PITCH, INCHES		
	MXL (0.080)	XL (0.200)	L (0.375)
3450	16	12	16
1750	14	12	14
1160	12	10	12
870	--	10	12

No increase in belt width will correct the adverse effects of using sub-minimum pulleys.

Figure 11 Inside & Outside Idlers

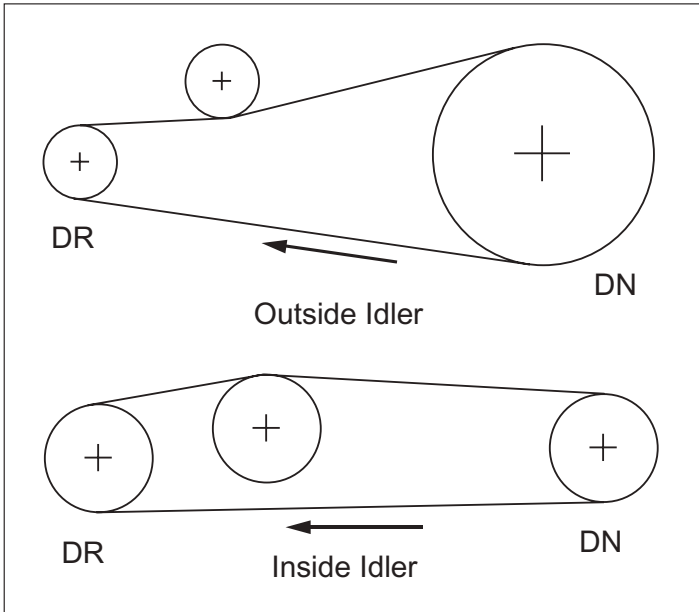

CENTER DISTANCE AND BELT LENGTH

The relationship between center distance and belt pitch length is given by the following formula:

$$L_p = 2C \cos \phi + \frac{\pi (D+d)}{2} + \frac{\pi \phi (D-d)}{180}$$

- where: L_p = pitch length of belt, inches
 C = center distance, inches
 D = pitch diameter of large pulley, inches
 d = pitch diameter of small pulley, inches
 ϕ = $\sin^{-1} (D-d/2C)$, degrees

The approximate center distance can be found by this formula:

$$C = \frac{K + \sqrt{K^2 - 32 (D-d)^2}}{16}$$

where: $K = 4L - 6.28 (D+d)$

The exact center distance can then be determined by trial, using the belt pitch length formula, or use center distance tables available from belt manufacturers.

Design software such as York Industries free DriveWorks program, can also be used to easily provide exact center distances and belt lengths.

The pitch length increment of a synchronous belt is equal to some multiple of the pitch of the belt. For example, the belt length increment of XL section (0.200 pitch) must be 0.200, 0.400, 0.600, etc.

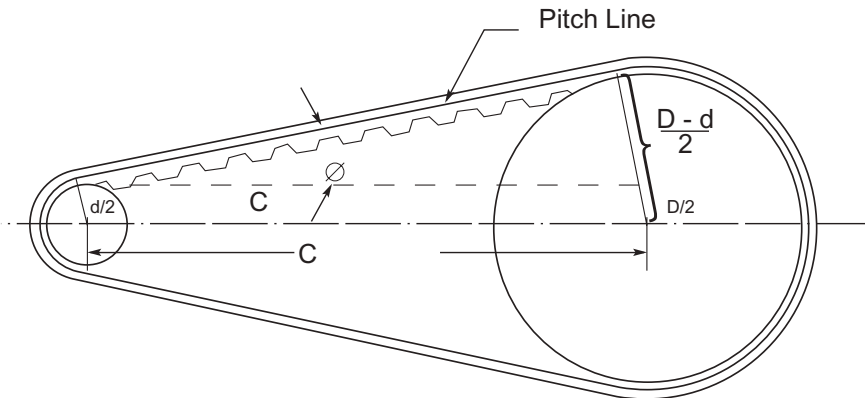

Table 18 Torque rating for MXL section (0.080 inch pitch)

BELT WIDTH, INCHES	RATED TORQUE (IBF-INCH) FOR SMALL PULLEY (NUMBER OF GROOVES AND PITCH DIAMETER, INCHES)									
	10MXL 0.255	12MXL 0.306	14MXL 0.357	16MXL 0.407	18MXL 0.458	20MXL 0.509	22MXL 0.560	24MXL 0.611	28MXL 0.713	30MXL 0.764
0.12	0.29	0.35	0.40	0.46	0.52	0.57	0.63	0.69	0.81	0.86
0.19	0.48	0.58	0.67	0.77	0.86	0.96	1.05	1.15	1.34	1.44
0.25	0.67	0.80	0.94	1.07	1.20	1.34	1.47	1.61	1.87	2.01

Table 19 Horsepower rating for .38 inch wide XL Section Belt (0.200 inch pitch)

RPM of Faster Shaft	RATED HORSEPOWER FOR SMALL PULLEY (NUMBER OF GROOVES AND PITCH DIAMETER)									
	10XL	12XL	14XL	16XL	18XL	20XL	22XL	24XL	28XL	30XL
	0.637	0.764	0.891	1.019	1.146	1.273	1.401	1.528	1.783	1.910
950	0.055	0.066	0.077	0.089	0.10	0.11	0.12	0.13	0.15	0.17
1160	0.068	0.081	0.095	0.11	0.12	0.14	0.15	0.16	0.19	0.20
1425	0.083	0.10	0.12	0.13	0.15	0.17	0.18	0.20	0.23	0.25
1750	0.10	0.12	0.14	0.16	0.18	0.20	0.22	0.24	0.28	0.30
2850	0.17	0.20	0.23	0.26	0.30	0.33	0.36	0.39	0.46	0.49
3450	0.20	0.24	0.28	0.32	0.36	0.40	0.43	0.47	0.55	0.58
100	0.006	0.007	0.008	0.009	0.010	0.012	0.013	0.014	0.016	0.017
200	0.012	0.014	0.016	0.019	0.021	0.023	0.026	0.028	0.033	0.035
300	0.018	0.021	0.024	0.028	0.031	0.035	0.038	0.042	0.049	0.052
400	0.023	0.028	0.033	0.037	0.042	0.047	0.051	0.056	0.065	0.070
500	0.029	0.035	0.041	0.047	0.052	0.058	0.064	0.070	0.082	0.087
600	0.035	0.042	0.049	0.056	0.063	0.070	0.077	0.084	0.098	0.10
700	0.041	0.049	0.057	0.065	0.073	0.082	0.090	0.098	0.11	0.12
800	0.047	0.056	0.065	0.075	0.084	0.093	0.10	0.11	0.13	0.14
900	0.053	0.063	0.073	0.084	0.094	0.10	0.12	0.13	0.15	0.16
1000	0.058	0.070	0.082	0.093	0.10	0.12	0.13	0.14	0.16	0.17
1100	0.064	0.077	0.090	0.10	0.12	0.13	0.14	0.15	0.18	0.19
1200	0.070	0.084	0.098	0.11	0.13	0.14	0.15	0.17	0.20	0.21
1300	0.076	0.091	0.11	0.12	0.14	0.05	0.17	0.18	0.21	0.23
1400	0.082	0.098	0.11	0.13	0.15	0.16	0.18	0.20	0.23	0.24
1500	0.087	0.10	0.12	0.14	0.16	0.17	0.19	0.21	0.24	0.26
1600	0.093	0.11	0.13	0.15	0.17	0.19	0.20	0.22	0.26	0.28
1700	0.099	0.12	0.14	0.16	0.18	0.20	0.22	0.24	0.28	0.30
1800	0.10	0.13	0.15	0.17	0.19	0.21	0.23	0.25	0.29	0.31
2000	0.12	0.14	0.16	0.19	0.21	0.23	0.26	0.28	0.32	0.35
2200	0.13	0.15	0.18	0.20	0.23	0.25	0.28	0.31	0.36	0.38
2400	0.14	0.17	0.20	0.22	0.25	0.28	0.31	0.33	0.39	0.41
2600	0.15	0.18	0.21	0.24	0.27	0.30	0.33	0.36	0.42	0.45
2800	0.16	0.20	0.23	0.26	0.29	0.32	0.36	0.39	0.45	0.48
3000	0.17	0.21	0.24	0.28	0.31	0.35	0.38	0.41	0.48	0.51
3200	0.19	0.22	0.26	0.30	0.33	0.37	0.40	0.44	0.51	0.54
3400	0.20	0.24	0.28	0.31	0.35	0.39	0.43	0.47	0.54	0.58
3600	0.21	0.25	0.29	0.33	0.37	0.41	0.45	0.49	1.57	0.61
3800	0.22	0.26	0.31	0.35	0.39	0.44	0.48	0.52	0.60	0.64
4000	0.23	0.28	0.32	0.37	0.41	0.46	0.50	0.54	0.63	0.67
4200	0.24	0.29	0.34	0.39	0.43	0.48	0.52	0.57	0.66	0.70
4400	0.26	0.31	0.35	0.40	0.45	0.50	0.55	0.59	0.68	0.73
4600	0.27	0.32	0.37	0.42	0.47	0.52	0.57	0.62	0.71	0.76
4800	0.28	0.33	0.39	0.44	0.49	0.54	0.59	0.64	0.74	0.79
5000	0.29	0.35	0.40	0.46	0.51	0.56	0.62	0.67	0.77	0.81
5500				0.50	0.56	0.62	0.67	0.73	0.83	0.88
6000				0.54	0.61	0.67	0.73	0.79	0.89	0.94
6500				0.59	0.65	0.72	0.78	0.84	0.95	1.00
7000				0.63	0.70	0.77	0.83	0.89	1.01	1.06
7500				0.67	0.74	0.81	0.88	0.94	1.06	1.10
8000					0.79	0.86	0.93	0.99	1.10	1.15
8500					0.83	0.90	0.97	1.03	1.14	1.18
9000					0.87	0.94	1.01	1.08	1.18	1.22
9500					0.91	0.98	1.05	1.11	1.21	1.24
10000					0.94	1.02	1.09	1.15	1.23	1.26

This pulley and rpm can be used only if a corresponding reduction in belt service life is allowable.

Table 20 Horsepower rating for 1.00 inch wide L section belt (0.375 inch pitch)

RPM of Faster Shaft	RATED HORSEPOWER FOR SMALL PULLEY (NUMBER OF GROOVES AND PITCH DIAMETER)															
	10L	12L	14L	15L	18L	20L	22L	24L	26L	28L	30L	32L	36L	40L	44L	48L
	1.194	1.432	1.671	1.910	2.149	2.387	2.628	2.865	3.104	3.342	3.581	3.820	4.297	4.775	5.252	5.730
725	0.38	0.45	0.53	0.60	0.68	0.75	0.83	0.90	0.98	1.05	1.13	1.20	1.35	1.50	1.64	1.79
870	0.45	0.54	0.63	0.72	0.81	0.90	0.99	1.08	1.17	1.26	1.35	1.44	1.61	1.79	1.96	2.14
950	0.49	0.59	0.69	0.79	0.89	0.99	1.08	1.18	1.28	1.37	1.47	1.57	1.76	1.95	2.14	2.32
1160	0.60	0.72	0.84	0.96	1.08	1.20	1.32	1.44	1.56	1.67	1.79	1.91	2.14	2.36	2.59	2.81
1425	0.74	0.89	1.03	1.18	1.33	1.47	1.62	1.76	1.90	2.04	2.18	2.32	2.60	2.87	3.14	3.40
1750	0.91	1.09	1.27	1.45	1.62	1.80	1.97	2.15	2.32	2.49	2.66	2.82	3.15	3.47	3.77	4.07
2850	1.76	2.04	2.32	2.60	2.87	3.14	3.40	3.65	3.89	4.13	4.36	4.79	5.17	5.52	5.81	
3450		2.46	2.79	3.11	3.42	3.73	4.02	4.30	4.57	4.82	5.06	5.48	5.84	6.11	6.29	
100	0.05	0.06	0.07	0.08	0.09	0.10	0.11	0.12	0.14	0.15	0.16	0.17	0.19	0.21	0.23	0.25
200	0.10	0.12	0.15	0.17	0.19	0.21	0.23	0.25	0.27	0.29	0.31	0.33	0.37	0.42	0.46	0.50
300	0.16	0.19	0.22	0.25	0.28	0.31	0.34	0.37	0.41	0.44	0.47	0.50	0.56	0.62	0.69	0.75
400	0.21	0.25	0.29	0.33	0.37	0.42	0.46	0.50	0.54	0.58	0.62	0.67	0.75	0.83	0.91	1.00
500	0.26	0.31	0.36	0.42	0.47	0.52	0.57	0.62	0.68	0.73	0.78	0.83	0.93	1.04	1.14	1.24
600	0.31	0.37	0.44	0.50	0.56	0.62	0.69	0.75	0.81	0.87	0.93	1.00	1.12	1.24	1.36	1.49
700	0.36	0.44	0.51	0.58	0.65	0.73	0.80	0.87	0.94	1.02	1.09	1.16	1.30	1.45	1.59	1.73
800	0.42	0.50	0.58	0.67	0.75	0.83	0.91	1.00	1.08	1.16	1.24	1.32	1.49	1.65	1.81	1.97
900	0.47	0.56	0.65	0.75	0.84	0.93	1.03	1.12	1.21	1.30	1.40	1.49	1.67	1.85	2.03	2.21
1000	0.52	0.62	0.73	0.83	0.93	1.04	1.14	1.24	1.34	1.45	1.55	1.65	1.85	2.05	2.25	2.44
1100	0.57	0.69	0.80	0.91	1.03	1.14	1.25	1.36	1.48	1.59	1.70	1.81	2.03	2.25	2.46	2.67
1200	0.62	0.75	0.87	1.00	1.12	1.24	1.36	1.49	1.61	1.73	1.85	1.97	2.21	2.44	2.67	2.90
1300	0.63	0.81	0.94	1.08	1.21	1.34	1.48	1.61	1.74	1.87	2.00	2.13	2.38	2.63	2.88	3.12
1400	0.73	0.87	1.02	1.16	1.30	1.45	1.59	1.73	1.87	2.01	2.15	2.29	2.56	2.82	3.09	3.34
1500	0.78	0.93	1.09	1.24	1.40	1.55	1.70	1.85	2.00	2.15	2.30	2.44	2.73	3.01	3.29	3.56
1600	0.83	1.00	1.16	1.32	1.49	1.65	1.81	1.97	2.13	2.29	2.44	2.60	2.90	3.20	3.49	3.77
1700	0.88	1.06	1.23	1.41	1.58	1.75	1.92	2.09	2.26	2.42	2.59	2.75	3.07	3.38	3.68	3.97
1800		1.12	1.30	1.49	1.67	1.85	2.03	2.21	2.38	2.56	2.73	2.90	3.23	3.56	3.87	4.17
1900		1.18	1.37	1.57	1.76	1.95	2.14	2.32	2.51	2.69	2.87	3.05	3.40	3.73	4.05	4.36
2000		1.24	1.45	1.65	1.85	2.05	2.25	2.44	2.63	2.82	3.01	3.20	3.56	3.90	4.23	4.54
2200		1.36	1.59	1.81	2.03	2.25	2.46	2.67	2.88	3.09	3.29	3.49	3.87	4.23	4.57	4.89
2400		1.49	1.73	1.97	2.21	2.44	2.67	2.90	3.12	3.34	3.56	3.77	4.17	4.54	4.89	5.21
2600		1.61	1.87	2.13	2.38	2.63	2.88	3.12	3.36	3.59	3.82	4.04	4.45	4.84	5.19	5.50
2800		1.73	2.01	2.29	2.56	2.82	3.09	3.34	3.59	3.83	4.07	4.30	4.72	5.11	5.45	5.75
3000		1.85	2.15	2.44	2.73	3.01	3.29	3.56	3.82	4.07	4.31	4.54	4.98	5.36	5.69	5.97
3200			2.29	2.60	2.90	3.20	3.49	3.77	4.04	4.29	4.54	4.78	5.21	5.59	5.90	6.14
3400			2.42	2.75	3.07	3.38	3.68	3.97	4.25	4.51	4.77	5.00	5.43	5.79	6.07	6.27
3600			2.56	2.90	3.23	3.56	3.87	4.17	4.45	4.72	4.98	5.21	5.63	5.97	6.21	6.35
3800			2.69	3.05	3.40	3.73	4.05	4.36	4.65	4.92	5.17	5.41	5.81	6.11	6.31	6.39
4000			2.82	3.20	3.56	3.90	4.23	4.54	4.84	5.11	5.36	5.59	5.97	6.23	5.96.37	6.30
4200				3.34	3.71	4.07	4.40	4.72	5.02	5.29	5.53	5.75	6.10	6.32	6.39	6.37
4400				3.49	3.87	4.23	4.57	4.89	5.19	5.45	5.69	5.90	6.21	6.37	6.36	#6.17
4600				3.63	4.02	4.39	4.74	5.06	5.35	5.61	5.84	6.03	6.29	6.39	6.29	#5.98
4800				3.77	4.17	4.54	4.89	5.21	5.50	5.75	5.97	6.14	6.35	6.37	#6.17	#5.73
5000				3.90	4.31	4.69	5.04	5.36	5.64	5.88	6.09	6.23	6.38	6.31	#6.00	#5.41
5200				4.04	4.43	4.84	5.19	5.50	5.77	6.00	6.18	6.30	6.38	6.22	#5.78	#5.03
5400				4.17	4.59	4.98	5.32	5.63	5.89	6.10	6.25	6.35	6.36	6.36	#5.50	#4.57
5600				4.30	4.72	5.11	5.45	5.75	6.00	6.19	6.32	6.38	6.30	#3.90	#5.17	#4.05
5800				4.42	4.85	5.24	5.58	5.86	6.09	6.26	6.36	6.39	6.21	#5.68	#4.77	#3.44
6000				4.54	4.98	5.36	5.69	5.97	6.18	6.32	6.38	6.37	6.08	#5.41	#4.32	#2.76

This pulley and rpm can be used only if a corresponding reduction in belt service life is allowable.

Pulley Surface speeds over 6500 fpm; special pulleys are required.



BELT MATERIALS AND CONSTRUCTION

A timing belt has two main components - the cords that are molded inside it to carry the torque load and the plastic compound used to shape the teeth and cover the cord itself. Both are available in different materials for different types of belts. The end use of the belt is the major factor in determining what materials to use.

The cord is generally made from polyester, fiberglass, or Kevlar and does the work of transmitting the power in the drive system through the belt. It is wound perpendicular to the belt teeth so that it transmits the power applied to the belt in a linear way. The common example of belts that carry large loads are the serpentine belts used in automobile engines. Belts used in smaller drive systems such as York products go into don't have anything approaching the loads in a car engine. But in both cases, elongation (stretch) of the belt is minimal. Especially in small drive applications, belt stretch is practically non-existent since the cord materials are so strong in relation to the loads they are transmitting. Loads that are too high generally result not in cord breakage, but in the belt teeth jumping, or 'cogging' over the pulley teeth.

The plastic used in the molded belt is usually urethane, neoprene, or an engineered polymer with special properties.

The plastic is injected into a mold that already contains the wound cord and has accurate tooth profiles cut into the mold. Each different belt length requires a different mold since the exact number of teeth on the finished belt must also be in the mold to produce a finished, continuous belt with no beginning or end. A mold produces a 'sleeve' that is often 18 to 36 inches wide with the desired number of teeth. Special slitting tools are used to very accurately trim the sleeve into the desired belt widths. Urethane is often used to produce belts for food processing when FDA requirements must be met. Urethane also can be colored or left in a clear or natural state, which means that any particles are less likely to be seen than those from black neoprene belts. Neoprene is generally the standard material for timing belts since it has good wear characteristics and very accurately holds the tooth profile from the mold. York PowerGrip GT2 neoprene belts include a nylon fabric facing to reduce wear. Special requirements for low dust/particle applications such as clean rooms, medical, or even office copiers can be met with engineered polymers. York's TruMotion line of belts uses an EPDM polymer core with a nylon overcoating on all tooth wear surfaces to generate 78% less dust than neoprene while holding the tooth profile more accurately over thousands of hours of use than either neoprene or urethane belts.

Belt Material	Wear (Life)	Temp. Range	Dust	Low Cost	FDA Approved	AntiStatic Available
Neoprene	Better	Good	Good	Best	No	No
Urethane	OK	Better	Better	Better	Some grades	Some grades
Eng. Polymers (TruMotion)	Best	Best	Best	Good	No	No

TRUMOTION BELTS

York TruMotion belts use special materials and construction to produce a belt that is optimized for minimal tooth wear. The process of a belt tooth mating with a pulley tooth produces friction as the belt tooth engages and then disengages while the drive system operates. It is the face of the belt tooth that will generate heat and exhibit wear as this occurs. This results in fine dust particles that will, over time, fall from the belt at the disengagement end of the pulley. This dust can be objectionable from a cleanliness standpoint in applications such as electronic clean rooms, medical equipment, or even office products that need a clean, non-marking paper path. This dust is actually a byproduct of the tooth surface wear caused by friction. So TruMotion belts have a special nylon fabric facing on the tooth surfaces that acts to minimize friction and therefore wear during engagement and disengagement with the pulley teeth.

Nylon is a self-lubricating plastic that offers excellent wear characteristics. A common use for nylon is in automobile speedometer gears where there is toothed contact with metal transmission gears and operating lifetimes of hundreds of millions of revolutions are required.

York drive systems don't see those kinds of stresses, but the nylon material on the face of a TruMotion belt insures a precise tooth shape for over four times longer than with standard neoprene or urethane belts. This is important if drive accuracy is critical throughout the life of the drive. And TruMotion achieves this by minimizing wear and dust, providing an exceptionally clean belt.

The TruMotion belt material that surrounds the fiberglass cord is an engineered polymer that also contributes to cleanliness and precision running due to its strength and ability to firmly lock the nylon facing and cord material in place to absolutely minimize relative motion between them as the belt rotates. Yet it provides excellent flex and shock absorption to handle vibrations that occur in drive systems. TruMotion fills a unique niche when a drive design demands cleanliness or precision well beyond what an ordinary neoprene or urethane belt can provide. So if your design specification includes long belt life, high cleanliness requirements, or precision drive timing and alignment, TruMotion can help you achieve all of these.

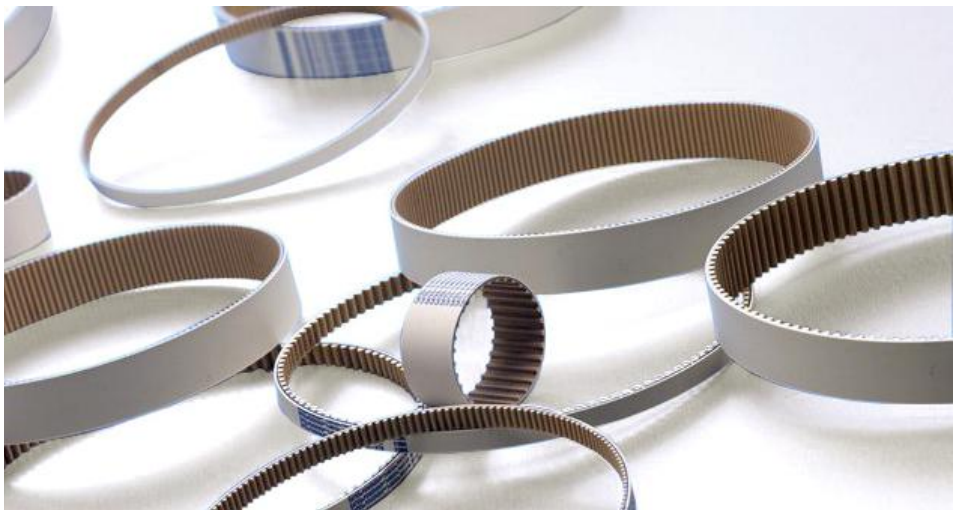

York also manufactures custom pulleys and complete assemblies
email: support@york-ind.com web: www.york-ind.com



SHAFT SAVER VS STANDARD SET SCREWS

A setscrew should:

- Hold the timing pulley tightly to the shaft and prevent slipping
- Allow you to easily readjust the pulley position to change drive system timing
- Allow field personnel to easily replace the timing pulley

A setscrew should not:

- Damage the shaft or mar it
- Impede replacement or adjustment of the timing pulley
- Require special tools or training to correctly use

Cup point setscrews are the industry standard for holding timing pulleys to shafts. They bite into the shaft and push it away from the setscrew so that the opposing side of the pulley hub is pulled into the shaft, providing the frictional force to keep the timing pulley in position. They also leave a ‘crater’ on the shaft where the point of the setscrew has dug into the shaft. Just like a crater on the moon, there is shaft material that gets pushed up around the point of the setscrew and a hole is formed on the shaft. So what may have started as a tight tolerance, precision ground shaft is out of spec after the first timing pulley is installed using a cup point screw.

York’s Shaft-Saver uses a special copper alloy tip that allows the tip to deform and conform to the shaft, rather than forcing the shaft to fit a cup pointed setscrew. The tip is reusable for a minimum of 10 times and still forces the opposite side of the hub against the shaft, allowing the timing pulley to grip tightly. And there is no crater or damage to the shaft, meaning that readjustment or replacement of the timing pulley is just as easy as the initial installation. No more gear pullers or hammers needed to replace or reposition a timing pulley. And Shaft-Saver installation is as intuitive as using a cup point screw, unlike specially modified or slotted pulley hubs which are prone to improper torquing or catching dirt in their slots.

York Shaft-Saver is the new standard for timing pulley installation and is available on any stock pulley that York manufactures.

Shaft-Saver:

- Direct replacement for standard timing pulleys
- Won’t mark shafts – won’t leave a pit, hole, or indentation
- Makes removing or readjusting the pulley on the shaft easy
- Works on hardened and ground or cold rolled shafts – just about any metal!
- Grips the shaft as tightly as a standard setscrew
- Grips and holds through grease, oil or dirt
- Reusable at least 10 times if you need to move the pulley on the shaft
- RoHS and REACH compatible
- In stock and low cost

TIMING PULLEY FASTENER SELECTION GUIDE							
Fastening Method	A	B	C	D	E	F	G
York Shaft-Saver	Y	Y	Y	Y	Y	Y	Y
Modified Hubs (Offset screws)	Y	Y	Y	n	Y	n	n
Clamps (Separate Components)	Y	n	n	Y	n	n	Y
Keys	n	n	n	n	n	Y	Y
Pins	n	n	n	n	Y	Y	Y
Cup Point Setscrews	n	n	n	n	Y	Y	Y

Legend:

- A – Shaft remains smooth and unmarked
- B – Self contained solution (no additional components needed)
- C – Part is fully supported on drive axis with no offset
- D – Easy readjustment
- E – Pinning is possible if needed
- F – Resistant to dirt and debris
- G – Holding power not overly sensitive to screw torque

SHAFT-SAVER - GRIPPING TORQUE VALUES

Shaft Dia.	Material, steel	Screw size	Shaft/hub break-away torque			
			Standard Allen Set Screw		Shaft-Saver Set Screw	
			1 scr.	2 scr.	1 scr.	2 scr.
.156	Hardened and ground	4-40	4		3	
.187	Hardened and ground	6-32	12		10	
.250	Hardened and ground	8-32	20	45	20	40
.312	Hardened and ground	8-32	32	42	30	52
.375	Hardened and ground	10-32	48	62	44	65

.250	Drill rod	8-32	25	45	32	40
.250	Cold rolled steel	8-32	20	35	12	22

1) Shafts sustained indentation damage from standard Allen set screws

Test Condition: Maximum recommended screw torque in an aluminum hub per SAE recommendation, steel screw, Aluminum 2024 T4 hub, no lubrication	Screw size	Torque inch/lb
	4-40	3
	6-32	6
	8-32	11
	10-32	20

TENSIONERS

Tensioners are useful additions to a drive design to deal with issues such as the fit of a belt or center distances between components. The purpose of a tensioner is to take up slack in a belt and maintain the tension of the belt so it doesn't slip against the pulleys while under load. Tensioners allow a designer to use a stock belt that may be slightly longer than what is required rather than pay for tooling a custom belt. Tensioners also adjust for tolerances in a drive system and can make installation and servicing of belts easier. A tensioner used as an idler in a design can enable an engineer to make sharp turns in a belt layout with the tensioner keeping proper tension in the belt and insuring that the belt doesn't slip against a pulley due to the sharp changes in belt direction. Not every drive requires a tensioner, but a tensioner is often useful to improve drive performance in actual use.

There are two basic designs for tensioners. Slotted tensioners move 'in and out' along a straight line, or slot, against the belt. A pivoting tensioner has a fixed pivot point and moves in an arc against the belt. The most common example of a pivoting tensioner is the one used on a car engine to tension the serpentine belt that drives all the accessories. Both types contain an idler at their ends which makes the actual contact with the belt and rotates to keep up with the belt so that there is no relative motion between their surfaces.

Tensioners can be either static (fixed) or dynamic (moving) in operation. A static tensioner means that the tension is set and the tensioner fastened into place to keep that specific tension against the belt during drive system operation. A dynamic tensioner uses some sort of a spring device to provide a known counterforce to push the tensioner into the belt to tension the belt.

The spring used in the tensioner design means the tensioner has the ability to move as the belt tension increases or decreases, making a dynamic tensioner an excellent choice for drives that do not have constant loads.

Tensioners can be placed either inside or outside of the belt, and on any span of a belt drive. It is generally better to place the tensioner on the belt span with the least tension (the slack span on a 2-pt drive). If the tensioner is going to put a lot of deflection on the belt then try to put it on the inside / tooth side of the design, as belts are manufactured to be shaped more easily from the inside, like they would be when going around a pulley. The idlers on inside tensioners should have the same profile as the belt they are pushing against. Outside tensioners are flat like the outside of the belt. They are useful to increase belt wrap around a pulley and are generally quieter, especially on high speed applications. Tensioners or idlers can also be used to change the belt direction and the design layout to get around obstacles that would otherwise interfere with a drive belt. In this case, a tensioner is actually functioning as an idler. By design, an idler has only one fixed position against a belt while a tensioner can be mounted through a range of positions relative to the belt.

Tensioners can be individually designed by a drive engineer or they can be purchased as preassembled components. York Industries has a line of stainless steel, small tensioners ideal for use in small synchronous drive systems. These complete tensioners can be ordered from stock in a number of pulley diameters, profiles, and heights above the mounting surface.

NOTES

York also manufactures custom pulleys and complete assemblies
email: support@york-ind.com web: www.york-ind.com



NOTES

TENSIONERS

TENSIONERS

York Industries

Manufacturing to customized specifications, and providing specialized design assistance, fast turnaround at every stage from prototype to production, and award winning quality since 1942.

TENSIONERS



Tensioners

Specifications & Engineering Data

About York Industries	T1
Introduction To Tensioners	T2
Dynamic Pivot – Size 4.....	T6
Dynamic Pivot – Size 3.....	T11
Dynamic Slot – Size 4.....	T15
Dynamic Slot – Size 3.....	T19
Static Pivot – Size 4.....	T23
Static Pivot – Size 3.....	T27
Static Slot – Size 4.....	T31
Static Slot – Size 3.....	T35
Mounting Your Tensioner With Spacers	T39

Patents: York tensioners are patent pending.

Trademarks: DRIVEWORKS, YORK-CAD, and YORK are registered trademarks owned by York Industries. POWERGRIP, GT2, POWERGRIP HTD and HTD are registered trademarks owned by Gates Corporation.

Catalog copyright 2011 by York Industries

York also manufactures custom pulleys and complete assemblies
email: support@york-ind.com web: www.york-ind.com



70 years of manufacturing achievement:

What makes York Industries an ideal manufacturer/supplier?

*York Industries is the expert in small synchronous drives with over **70 years** of success in manufacturing custom and standard timing pulleys, gears, gear racks and custom assemblies and supplying timing belts. Our traditional values of quality and dependability have endured due to constant investment into the company with the most up to date equipment in both manufacturing and inspection. Our new line of belt tensioners is a patented product of York Industries.*

Single Source Manufacturing & Customer Service:

York Industries is different, in that we provide a level of quality, precision and customer service from prototypes to production that goes well beyond our customer's expectations. We quote machined-to-print solutions for your cost savings analysis. You will have a single, dedicated customer service representative who knows who you are and is experienced with your needs.

ISO: 9001:2008 registered:

Every stock or custom product manufactured at our facility is to our own uncompromising standards. York is ISO: 9001:2008 certified. All products are RoHS compliant.

Quality Manufacturing:

Quality...York's obsession! We take quality very seriously, from review of prints to the final inspection. Your orders are manufactured with award-winning precision, on-time delivery, and one-on-one courteous customer service.

Technology Support:

In addition to expert engineering assistance, York provides its proprietary DriveWorks® 2 software — a full-featured engineering tool for designing and analyzing drive systems — without cost or obligation.

Flexibility:

Upon request, York offers: Just-In-Time delivery, Web-based supply chain participation, SPC (Statistical Process Control) and bar coding. York will gladly cross-reference competitors' stock part #'s. At York, we are experts at adapting to whatever needs that our customers may have.

INTRODUCTION TO TENSIONERS

York has designed four types of tensioners in two sizes to give you a choice of stock solutions for your drive design.

WHY TENSIONERS?

- Achieve exact center distances with stock belt lengths
- Compensate for wear or slack in the belt
- Prevent belt slippage
- Ease installation and servicing
- Adjust for drive tolerances
- Enable sharp turns in belt layout

WHY YORK TENSIONERS?

Flexible

- Universal - works with any small drive
- Slot and pivot designs available
- Extremely low belt clearance

Convenient

- Drops right into your design
- Small footprint
- Downloadable CAD drawings and 3D models already available
- Stock mounting spacers if needed in your design.

Cost Effective

- Standard catalog item
- Save cost of designing your own
- Save tooling costs

ALL YORK TENSIONERS ARE RoHS COMPLIANT

York also manufactures custom pulleys and complete assemblies
email: support@york-ind.com web: www.york-ind.com



DYNAMIC PIVOT

- Spring adjusts either CW or CCW
- Dual purpose - use statically or dynamically
- Fits easily inside or outside the belt

Size 4

Size 3

**DYNAMIC SLOT**

- Spring adjusts as belt ages
- Easy to adjust tension on belt
- Unique installation bushing

Size 4

Size 3

**STATIC PIVOT**

- Smallest footprint
- 44 degree arc of movement
- Wide span of travel

Size 4

Size 3

**STATIC SLOT**

- The classic tensioner
- Linear adjustment
- Small yet very strong

Size 4

Size 3



WHICH TYPE TENSIONER SHOULD I USE?

SLOTTED VS. PIVOTING TENSIONERS

The choice of slotted versus pivoting tensioners is usually based on drive geometry, the drive layout, and the available space and mounting structures. Both tensioner types are usually mounted with their direction of travel bisecting the belt path to take full advantage of their range of motion and spring force. Because of their geometry, slotted tensioners rarely find use as inside idler pulleys on short center distance drives unless the drive has large diameter sprockets. Because of a pivoting tensioner's physical construction they can often fit where a slotted tensioner cannot.

STATIC VS. DYNAMIC DESIGN CONSIDERATIONS

Because they are self adjusting, dynamic tensioners are most useful for drives where accessing the drive for tension measurement is difficult or where drive assemblers or field service people do not have accurate tools or jigs to accurately tension the drive.

Note: Dynamic tensioners should generally be locked in place once spring pressure applies the proper tension. Avoid using a non-locked spring loaded tensioner on a reversing drive unless the belt is only lightly loaded in the reverse direction (where the tensioner is on the tight span). Do not use a non-locked dynamic tensioner on applications where high load fluctuations are likely to occur.

TENSIONER PLACEMENT

Tensioners can be placed either inside or outside of the belt, and on any span of a belt drive. Idler pulleys / tensioners will produce additional bending stress to the belt. The negative effects can be minimized with proper sizing and location. It is generally better to place the tensioner on the belt span with the least tension (slack span on a 2-pt drive) and on the inside / tooth side, as belts are manufactured to be shaped more easily in the inward direction. Outside tensioners are useful to increase belt wrap and are generally quieter especially on high speed applications.

After choosing your type of tensioner (slot or pivot and their dynamic or static versions), pick your specific tensioner size use the following chart. Be sure to call York at (800) 354-8466 / (516) 746-3736 with any questions you have.

Size 4 Tensioners

(dimensions in inches)	Min Pulley Height Above Mounting Plate (1)	Range of Adjustment (2)	Tensioner Stroke (3)	Continuous Max Force Against Belt	Peak Shock Loads	Approx Footprint w/o Pulley
SS-4 Static Slot Tensioner	0.18	0.80	n/a	10 lbs	15 lbs	.90 wide x 2.6 long
DS-4 Dynamic Slot Tensioner	0.23	0.80	0.35	5 lbs	15 lbs	.90 wide x 3.1 long
SP-4 Static Pivot Tensioner	0.18	1.25 44 deg	n/a	10 lbs	15 lbs	1.12 wide x 2.25 long
DP-4 Dynamic Pivot Tensioner	0.23	1.25 22 deg	0.50	5 lbs*	15 lbs	1.70 wide x 2.55 long

Size 3 Tensioners

*(8 lbs max available as special order)

(dimensions in inches)	Min Pulley Height Above Mounting Plate (1)	Range of Adjustment (2)	Tensioner Stroke (3)	Continuous Max Force Against Belt	Peak Shock Loads	Approx Footprint w/o Pulley
SS-3 Static Slot Tensioner	0.18	0.50	n/a	8 lbs	10 lbs	.85 wide x 1.81 long
DS-3 Dynamic Slot Tensioner	0.21	0.50	0.25	2.5 lbs	10 lbs	.95 wide x 2.07 long
SP-3 Static Pivot Tensioner	0.18	0.73 44 deg	n/a	8 lbs	10 lbs	.70 wide x 1.36 long
DP-3 Dynamic Pivot Tensioner	0.21	1.20 75 deg	0.73	2.5 lbs*	10 lbs	1.2 wide x 1.5 long

*(5 lbs max available as special order)

1. **Minimum pulley height** for Size 4 is .05 higher for plastic sleeved bearings, for Size 3 add .03
2. **Adjustment** is the movement possible when mounting the tensioner to its mounting surface.
3. **Stroke** is the range of operating travel possible for a mounted, dynamic tensioner from stop to stop of the spring

Maximum pulley height above the mounting surface depends on specific pulley width. Consult factory for details.

York also offers extruded spacers in .38 inch increments up to 1.12 thick for Size 4 tensioners and in .25 inch increments up to .75 inches for Size 3 tensioners to lift the the entire tensioner above its mounting surface yet provide excellent mechanical holding for drive operation. So generally, pulley clearances up to nearly 1 inch from the mounting surface are not a problem.

Size 4 Dynamic Pivot Tensioners

Dynamic pivot tensioners are ideal when you have space limitations and need adjustment for installation and service.

- Small but tough
- Pivots CW or CCW
- 1.12 inch range of adjustment
- Stainless steel spring
- Standard catalog item
- RoHS Compliant



FEATURES:

The DP-4 gives you

- .23 inch minimum idler pulley clearance
- Tensioner stroke of .50 inches across a 22 degree arc
- Self contained spring with 5 pounds continuous force, withstands 15 pounds peak
- Engineered and tested for over 1 million cycles

All York tensioners include

- Huge selection of catalog tensioners
- Universal - inside or outside tensioner
- Small footprint yet strong
- Markings to help set belt tension
- Stainless steel construction
- Aluminum or plastic idler pulleys
- Choice of flat pulley or six belt profiles: 2mm GT2, 3mm GT2, MXL, 3mm HTD, 5mm HTD or XL
- Sealed ball or sleeved plastic bearings
- Captive hardware for easy installation

York also manufactures custom pulleys and complete assemblies
 email: support@york-ind.com web: www.york-ind.com



Size 4 Tensioners

Engineering Drawings: DP-4**DP- 4 DYNAMIC PIVOT TENSIONER**

The Dynamic Tensioner uses just a small space to provide constant pressure against a belt even as wear and stretch occur. Plus the tensioner can be locked statically into place if desired after tension is set.

Operating Characteristics

Tensioner stroke - .50 inches (12.7 mm) over a 22 degree arc

Range of adjustment - 1.12 inches (28.4 mm)

Maximum force against belt - 5 pounds (2.3 kg) continuous, 15 pounds (6.8 kg) peak (10 pounds (4.6 kg) continuous available as a special order)

*** Mounting Data:**

- Approximate footprint without idler pulley of 1.70 inches (43.2 mm) wide by 2.55 inches (64.8 mm) long
- Minimum clearance from mounting surface to bottom of pulley is .23 inches (5.8 mm) except plastic sleeve bearings require .28 inches (7.1 mm) minimum clearance.
- Requires one hole tapped 10-32 or M5 x .8 either through sheetmetal, or blind hole with minimum .38 thread depth. Also needs one .25 diameter by .25 min depth clearance hole. See drawing below.

**** Tensioner Height:**

To find your tensioner height, determine Pulley Width + Belt Clearance desired = X

- If X is less than or equal to .675 (17.1 mm), tensioner height is 1.000 (25.4 mm)
- If X is between .675 (17.1 mm) and .950 (24.1 mm), tensioner height is 1.275 (32.4 mm)
- If X is larger than .950 (24.1 mm), consult York Engineering.

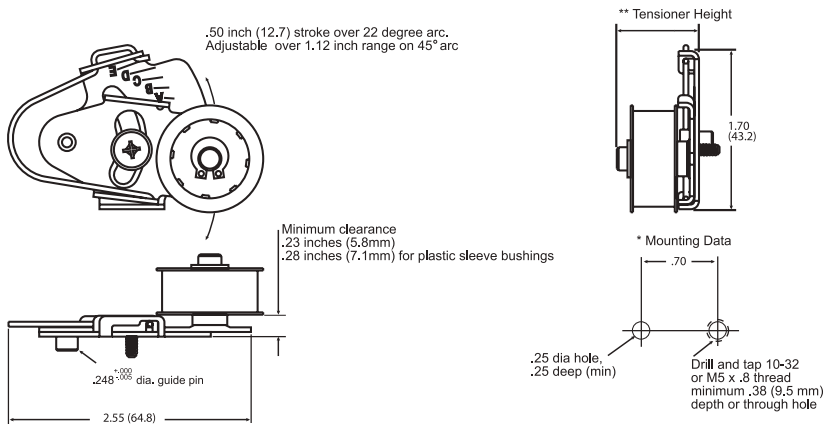

All York Size 4 Tensioners Include:

301 stainless steel construction for strength and harsh environments	Designs tested to over one million cycles
Operating temperatures possible from -60°F to +185°F	Survives salt spray, dust, and condensing high humidity environments with proper bearings
Choice of idler pulley profiles - flat, 2mm GT2, 3mm GT2, MXL, XL, 3mm HTD or 5mm HTD	Idler pulleys available with sealed ball bearings, self lubricating plastic sleeves in aluminum pulleys or self lubricating all plastic pulleys
Ease of assembly with self locking, reusable Phillips hardware in 10-32 or M5 x.8 threads	Idler pulley retaining clip withstands minimum of 15 lbs (6.8 kg) pull force
Downloadable CAD files for tensioners and pulleys	Dynamic tensioners have reference markings to aid in setting belt tension during assembly and service
Free access to York's engineering staff for answers to design and application questions	Conductive grease (sealed ball bearings) or static dissipative (plastic) to prevent static electricity build-up on belts
Special mounting bushing to aid in setting belt tension.	Idler shafts are 416 stainless steel hardened to Rockwell C 38-42

Operating Environments:

Idler Pulley/Bearing Type	Maximum Operating Temperature	Minimum Operating Temperature	High Dust Environments	High Humidity	Relative Cost	Max Speed in RPM
Aluminum/Ball Bearing	185°F - may be limited by belt max temp	-60°F	Yes - Sealed ABEC Bearings With Conductive Grease	Yes	More Expensive	Limited by belt, not bearing
Aluminum/Plastic Self Lubricating Sleeve	185°F - may be limited by belt max temp	-40°F	OK in most cases	Yes	Moderate good for small and medium volumes	Up to 4,500 RPM continuous with up to 9,000 RPM peak.
One Piece Self Lubricating Carbon Filled Polycarbonate UL V94-0 Flammability	180°F	20°F (consult York for designs down to -40°F)	Generally not for extremely high dust areas	Yes - to 95% but must be non condensing	Least Expensive Need high volumes if custom mold required	Up to 4,500 RPM continuous with up to 7,000 RPM peak

York also manufactures custom pulleys and complete assemblies
 email: support@york-ind.com web: www.york-ind.com



IN STOCK DP-4 TENSIONERS



MAX. BELT WIDTH
3/8" (9mm)

MAX. SPRING FORCE
5 LBS.

MOUNTING SCREW
10-32 x 1/2

TENSIONER PART NUMBER	PULLEY PITCH	NO. OF GROOVES	PULLEY O.D.	PULLEY MATERIAL	PULLEY HEIGHT	BEARING TYPE	SPRING DIRECTION
DP4UB-F100L42-N23PE-CWS	FLAT	N/A	1"	PLASTIC	.23"	N/A	CW
DP4UB-F100L42-N23PE-ACS	FLAT	N/A	1"	PLASTIC	.23"	N/A	CCW
DP4UB-F100A42-B23PE-CWS	FLAT	N/A	1"	ALUMINUM	.23"	BALL	CW
DP4UB-F100A42-B23PE-ACS	FLAT	N/A	1"	ALUMINUM	.23"	BALL	CCW
DP4UB-F100A42-S28PE-CWS	FLAT	N/A	1"	ALUMINUM	.28"	SLEEVE	CW
DP4UB-F100A42-S28PE-ACS	FLAT	N/A	1"	ALUMINUM	.28"	SLEEVE	CCW
DP4UB-2G40A107-B58PE-CWS	2mm GT2	40	.983"	ALUMINUM	5.8mm	BALL	CW
DP4UB-2G40A107-B58PE-ACS	2mm GT2	40	.983"	ALUMINUM	5.8mm	BALL	CCW
DP4UB-2G40A107-S71PE-CWS	2mm GT2	40	.983"	ALUMINUM	7.1mm	SLEEVE	CW
DP4UB-2G40A107-S71PE-ACS	2mm GT2	40	.983"	ALUMINUM	7.1mm	SLEEVE	CCW
DP4UB-3G28A107-B58PE-CWS	3mm GT2	28	1.023"	ALUMINUM	5.8mm	BALL	CW
DP4UB-3G28A107-B58PE-ACS	3mm GT2	28	1.023"	ALUMINUM	5.8mm	BALL	CCW
DP4UB-3G28A107-S71PE-CWS	3mm GT2	28	1.023"	ALUMINUM	7.1mm	SLEEVE	CW
DP4UB-3G28A107-S71PE-ACS	3mm GT2	28	1.023"	ALUMINUM	7.1mm	SLEEVE	CCW
DP4UB-MX40A42-B23PE-CWS	MXL (.080")	40	.999"	ALUMINUM	.23"	BALL	CW
DP4UB-MX40A42-B23PE-ACS	MXL (.080")	40	.999"	ALUMINUM	.23"	BALL	CCW
DP4UB-MX40A42-S28PE-CWS	MXL (.080")	40	.999"	ALUMINUM	.28"	SLEEVE	CW
DP4UB-MX40A42-S28PE-ACS	MXL (.080")	40	.999"	ALUMINUM	.28"	SLEEVE	CCW
DP4UB-3M28A107-B58PE-CWS	3mm HTD	28	1.023"	ALUMINUM	5.8mm	BALL	CW
DP4UB-3M28A107-B58PE-ACS	3mm HTD	28	1.023"	ALUMINUM	5.8mm	BALL	CCW



TENSIONER PART NUMBER	PULLEY PITCH	NO.OF GROOVES	PULLEY O.D.	PULLEY MATERIAL	PULLEY HEIGHT	BEARING TYPE	SPRING DIRECTION
DP4UB-3M28A107-S71PE-CWS	3mm HTD	28	1.023"	ALUMINUM	7.1mm	SLEEVE	CW
DP4UB-3M28A107-S71PE-ACS	3mm HTD	28	1.023"	ALUMINUM	7.1mm	SLEEVE	CCW
DP4UB-5M17A107-B58PE-CWS	5mm HTD	17	1.020"	ALUMINUM	5.8mm	BALL	CW
DP4UB-5M17A107-B58PE-ACS	5mm HTD	17	1.020"	ALUMINUM	5.8mm	BALL	CCW
DP4UB-5M17A107-S71PE-CWS	5mm HTD	17	1.020"	ALUMINUM	7.1mm	SLEEVE	CW
DP4UB-5M17A107-S71PE-ACS	5mm HTD	17	1.020"	ALUMINUM	7.1mm	SLEEVE	CCW
DP4UB-XL16A42-B23PE-CWS	XL (1/5")	16	.999"	ALUMINUM	.23"	BALL	CW
DP4UB-XL16A42-B23PE-ACS	XL (1/5")	16	.999"	ALUMINUM	.23"	BALL	CCW
DP4UB-XL16A42-S28PE-CWS	XL (1/5")	16	.999"	ALUMINUM	.28"	SLEEVE	CW
DP4UB-XL16A42-S28PE-ACS	XL (1/5")	16	.999"	ALUMINUM	.28"	SLEEVE	CCW

IF A STOCK TENSIONER DOES NOT MEET YOUR REQUIREMENTS,
 PLEASE CONFIGURE YOUR OWN CUSTOM TENSIONER AT
www.york-ind.com

York also manufactures custom pulleys and complete assemblies
 email: support@york-ind.com web: www.york-ind.com



Size 3 Dynamic Pivot Tensioners

Dynamic pivot tensioners are ideal for tight spaces and when you need adjustments for installation and service.

- Small but tough
- Pivots CW or CCW
- 1.20 range of adjustment
- Stainless steel spring
- Standard catalog item
- RoHS Compliant

DP-3

FEATURES:

The DP-3 gives you

- .21 inch minimum idler pulley clearance
- Tensioner stroke of .73 inches
- Self contained spring with 2.5 pounds continuous force, withstands 10 pounds peak
- Engineered and tested for over 1 million cycles

All York tensioners include

- Huge selection of catalog tensioners
- Universal - inside or outside tensioner
- Small footprint yet strong
- Markings to help set belt tension
- Stainless steel construction
- Aluminum or plastic idler pulleys
- Choice of flat pulley or four belt profiles: 2mm GT2, 3mm GT2, .080 (MXL) and 3mm HTD
- Sealed ball or sleeved plastic bearings
- Captive hardware for easy installation

Engineering Drawings: DP-3

DP-3 DYNAMIC PIVOT TENSIONER

Constant belt pressure in a small space, the DP-3 compensates for wear, stretch, and fluctuating load in your drive system. Graduations on the mounting bracket aid in assembly and service. If desired, tensioner can be locked statically into place after tension is set.

Operating Characteristics

Tensioner stroke - .73 inches (18.5 mm)

Range of adjustment - 1.20 inches (30.5 mm) over a 75 degree arc

Maximum force against belt - 2.5 pounds (1.1 kg) continuous, 10 pounds (4.5 kg) peak

* Mounting Data:

- Approximate footprint without pulley of 1.2 inches (30.5 mm) wide by 1.5 inches (38.1 mm) long
- Minimum clearance from mounting surface to bottom flange of pulley is .21 inches (5.3 mm) for self lubricating pulley or ball bearings. Plastic sleeve bearings require .24 (6.1 mm) minimum clearance.
- Requires one #6-32 threaded hole and one .125 clearance hole. See drawing below

** Tensioner Height:

To determine tensioner maximum height, add total end to end pulley width desired + pulley clearance from mounting surface desired = X

- If X is less than or equal to .687 (17.4 mm), tensioner maximum height is .702 (17.8 mm)
- If X is greater than .687 (17.4 mm), consult York Engineering for available optional shafts and mounting bases.

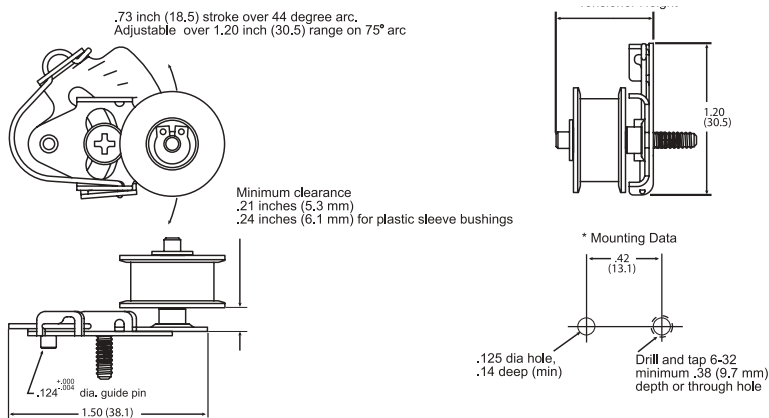

All York Size 3 Tensioners Include:

301 stainless steel construction for strength and harsh environments	Designs tested to over one million cycles
Operating temperatures possible from -60°F to +185°F	Survives salt spray, dust, and condensing high humidity environments with proper bearings
Choice of idler pulley profiles - flat, 2mm GT2, 3mm GT2, .080 (MXL) or 3mm HTD	Idler pulleys available with sealed ball bearings, self lubricating plastic sleeves in aluminum pulleys or self lubricating all plastic pulleys
Ease of assembly with self locking, reusable Phillips hardware in 6-32 threads	Idler pulley retaining clip withstands minimum of 10 lbs (4.5 kg) pull force/side force on pulley
Downloadable CAD files for tensioners and pulleys	Dynamic tensioners have reference markings for setting belt tension during assembly and service
Free access to York's engineering staff for answers to design and application questions	Conductive grease (sealed ball bearings) or static dissipative (plastic) to prevent static electricity build-up on belts
Special mounting bushing to aid in setting belt tension.	Idler shafts are 416 stainless steel hardened to Rockwell C 38-42

Operating Environments:

Idler Pulley/Bearing Type	Maximum Operating Temperature	Minimum Operating Temperature	High Dust Environments	High Humidity	Relative Cost	Max Speed in RPM
Aluminum/Ball Bearing	185°F - may be limited by belt max temp	-60°F	Yes - Sealed ABEC Bearings With Conductive Grease	Yes	More Expensive	Limited by belt, not bearing
Aluminum/Plastic Self Lubricating Sleeve	185°F - may be limited by belt max temp	-40°F	OK in most cases	Yes	Moderate good for small and medium volumes	Up to 4,500 RPM continuous with up to 9,000 RPM peak.
One Piece Self Lubricating Carbon Filled Polycarbonate UL V94-0 Flammability	180°F	20°F (consult York for designs down to -40°F)	Generally not for extremely high dust areas	Yes - to 95% but must be non condensing	Least Expensive Need high volumes if custom mold required	Up to 4,500 RPM continuous with up to 7,000 RPM peak

IN STOCK DP-3 TENSIONERS



MAX. BELT WIDTH
1/4" (6mm)

MAX. SPRING FORCE
2.5 LBS.

MOUNTING SCREW
6-32 x 1/2

TENSIONER PART NUMBER	PULLEY PITCH	NO.OF GROOVES	PULLEY O.D.	PULLEY MATERIAL	PULLEY HEIGHT	BEARING TYPE	SPRING DIRECTION
DP3UB-F63L29-N21PE-CWS	FLAT	N/A	.625"	PLASTIC	.21"	NONE	CW
DP3UB-F63L29-N21PE-ACS	FLAT	N/A	.625"	PLASTIC	.21"	NONE	CCW
DP3UB-F63A29-S24PE-CWS	FLAT	N/A	.625"	ALUMINUM	.24"	SLEEVE	CW
DP3UB-F63A29-S24PE-ACS	FLAT	N/A	.625"	ALUMINUM	.24"	SLEEVE	CCW
DP3UB-F63A29-B21PE-CWS	FLAT	N/A	.625"	ALUMINUM	.21"	BALL	CW
DP3UB-F63A29-B21PE-ACS	FLAT	N/A	.625"	ALUMINUM	.21"	BALL	CCW
DP3UB-MX24A29-S24PE-CWS	MXL (.080")	24	.591"	ALUMINUM	.24"	SLEEVE	CW
DP3UB-MX24A29-S24PE-ACS	MXL (.080")	24	.591"	ALUMINUM	.24"	SLEEVE	CCW
DP3UB-MX24A29-B21PE-CWS	MXL (.080")	24	.591"	ALUMINUM	.21"	BALL	CW
DP3UB-MX24A29-B21PE-ACS	MXL (.080")	24	.591"	ALUMINUM	.21"	BALL	CCW
DP3UB-2G24A74-S61PE-CWS	2mm GT2	24	.582"	ALUMINUM	6.1mm	SLEEVE	CW
DP3UB-2G24A74-S61PE-ACS	2mm GT2	24	.582"	ALUMINUM	6.1mm	SLEEVE	CCW
DP3UB-2G24A74-B53PE-CWS	2mm GT2	24	.582"	ALUMINUM	5.3mm	BALL	CW
DP3UB-2G24A74-B53PE-ACS	2mm GT2	24	.582"	ALUMINUM	5.3mm	BALL	CCW
DP3UB-3G18A74-S61PE-CWS	3mm GT2	18	.647"	ALUMINUM	6.1mm	SLEEVE	CW
DP3UB-3G18A74-S61PE-ACS	3mm GT2	18	.647"	ALUMINUM	6.1mm	SLEEVE	CCW
DP3UB-3G18A74-B53PE-CWS	3mm GT2	18	.647"	ALUMINUM	5.3mm	BALL	CW
DP3UB-3G18A74-B53PE-ACS	3mm GT2	18	.647"	ALUMINUM	5.3mm	BALL	CCW
DP3UB-3M18A74-S61PE-CWS	3mm HTD	18	.647"	ALUMINUM	6.1mm	SLEEVE	CW
DP3UB-3M18A74-S61PE-ACS	3mm HTD	18	.647"	ALUMINUM	6.1mm	SLEEVE	CCW
DP3UB-3M18A74-B53PE-CWS	3mm HTD	18	.647"	ALUMINUM	5.3mm	BALL	CW
DP3UB-3M18A74-B53PE-ACS	3mm HTD	18	.647"	ALUMINUM	5.3mm	BALL	CCW

York also manufactures custom pulleys and complete assemblies
 email: support@york-ind.com web: www.york-ind.com



Size 4 Dynamic Slot Tensioners

Enhanced slot tensioner design. Self adjusting, easily locks down or let it float to suit your application.

- Linear movement
- Choice of pulleys and bearings
- Spring can push or pull pulley
- Adjusts over .80 inch range
- Standard catalog item
- RoHS Compliant



FEATURES:

The DS-4 gives you

- .23 inch minimum idler pulley clearance
- Tensioner stroke of .25 inches
- Self contained spring with 5 pounds continuous force, withstands 15 pounds peak
- Engineered and tested for over 1 million cycles

All York tensioners include

- Huge selection of catalog tensioners
- Universal - inside or outside tensioner
- Small footprint yet strong
- Markings to help set belt tension
- Stainless steel construction
- Aluminum or plastic idler pulleys
- Choice of flat pulley or six belt profiles: 2mm GT2, 3mm GT2, MXL, 3mm HTD, 5mm HTD or XL
- Sealed ball or sleeved plastic bearings
- Captive hardware for easy installation

Engineering Drawings: DS-4

DS-4 DYNAMIC SLOT TENSIONER

The Dynamic Slotted Tensioner provides continuous pressure on the belt over the life of the drive system. Assembly and service are often easier and more accurate with a dynamic tensioner. Plus the tensioner can be locked statically into place if desired after tension is set.

Operating Characteristics

Tensioner stroke - .25 inches (6.4 mm)

Range of adjustment - .80 inches (20 mm)

Maximum force against belt - 5 pounds (2.3 kg) continuous, 15 pounds (6.8 kg) peak

Spring can be mounted to push on idler pulley (as shown) or to pull

* Mounting Data:

- Approximate footprint without idler pulley of .90 inches (22.9 mm) wide by 3.1 inches (78.7 mm) long
- Minimum clearance from mounting surface to bottom of pulley is .23 inches (5.8 mm) except plastic sleeve bearings require .28 inches (7.1 mm) minimum clearance.
- Requires one hole tapped 10-32 or M5 x .8 either through sheetmetal, or blind hole with minimum .38 thread depth. See drawing below.

** Tensioner Height:

To find your tensioner height, determine Pulley Width + Belt Clearance desired = X

- If X is less than or equal to .675 (17.1 mm), tensioner height is 1.000 (25.4 mm)
- If X is between .675 (17.1 mm) and .950 (24.1mm), tensioner height is 1.275 (32.4 mm)
- If X is larger than .950 (24.1 mm), consult York Engineering

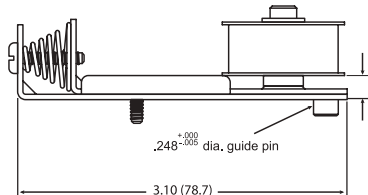
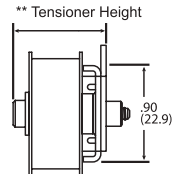
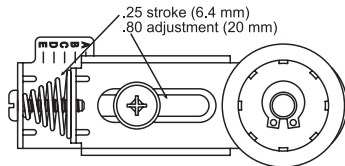

Minimum clearance
 .23 inches (5.8 mm)
 .28 inches / 7.1 mm for plastic sleeve bushings

* Mounting Data

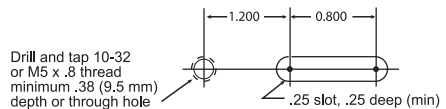

All York Size 4 Tensioners Include:

301 stainless steel construction for strength and harsh environments	Designs tested to over one million cycles
Operating temperatures possible from -60°F to +185°F	Survives salt spray, dust, and condensing high humidity environments with proper bearings
Choice of idler pulley profiles - flat, 2mm GT2, 3mm GT2, MXL, XL, 3mm HTD or 5mm HTD	Idler pulleys available with sealed ball bearings, self lubricating plastic sleeves in aluminum pulleys or self lubricating all plastic pulleys
Ease of assembly with self locking, reusable Phillips hardware in 10-32 or M5 x.8 threads	Idler pulley retaining clip withstands minimum of 15 lbs (6.8 kg) pull force
Downloadable CAD files for tensioners and pulleys	Dynamic tensioners have reference markings for setting belt tension during assembly and service
Free access to York's engineering staff for answers to design and application questions	Conductive grease (sealed ball bearings) or static dissipative (plastic) to prevent static electricity build-up on belts
Special mounting bushing to aid in setting belt tension.	Idler shafts are 416 stainless steel hardened to Rockwell C 38-42

Operating Environments:

Idler Pulley/Bearing Type	Maximum Operating Temperature	Minimum Operating Temperature	High Dust Environments	High Humidity	Relative Cost	Max Speed in RPM
Aluminum/Ball Bearing	185°F - may be limited by belt max temp	-60°F	Yes - Sealed ABEC Bearings With Conductive Grease	Yes	More Expensive	Limited by belt, not bearing
Aluminum/Plastic Self Lubricating Sleeve	185°F - may be limited by belt max temp	-40°F	OK in most cases	Yes	Moderate good for small and medium volumes	Up to 4,500 RPM continuous with up to 9,000 RPM peak.
One Piece Self Lubricating Carbon Filled Polycarbonate UL V94-0 Flammability	180°F	20°F (consult York for designs down to -40°F)	Generally not for extremely high dust areas	Yes - to 95% but must be non condensing	Least Expensive Need high volumes if custom mold required	Up to 4,500 RPM continuous with up to 7,000 RPM peak

IN STOCK DS-4 TENSIONERS



MAX. BELT WIDTH
3/8" (9mm)
MAX. SPRING FORCE
5 LBS.
MOUNTING SCREW
10-32 x 1/2

TENSIONER PART NUMBER	PULLEY PITCH	NO.OF GROOVES	PULLEY O.D.	PULLEY MATERIAL	PULLEY HEIGHT	BEARING TYPE	SPRING DIRECTION
DS4UB-F100L42-N23PE-PS	FLAT	N/A	1"	PLASTIC	.23"	N/A	PUSH
DS4UB-F100A42-B23PE-PS	FLAT	N/A	1"	ALUMINUM	.23"	BALL	PUSH
DS4UB-F100A42-S28PE-PS	FLAT	N/A	1"	ALUMINUM	.28"	SLEEVE	PUSH
DS4UB-2G40A107-B58PE-PS	2mm GT2	40	.983"	ALUMINUM	5.8mm	BALL	PUSH
DS4UB-2G40A107-S71PE-PS	2mm GT2	40	.983"	ALUMINUM	7.1mm	SLEEVE	PUSH
DS4UB-3G28A107-B58PE-PS	3mm GT2	28	1.023"	ALUMINUM	5.8mm	BALL	PUSH
DS4UB-3G28A107-S71PE-PS	3mm GT2	28	1.023"	ALUMINUM	7.1mm	SLEEVE	PUSH
DS4UB-MX40A42-B23PE-PS	MXL (.080")	40	.999"	ALUMINUM	.23"	BALL	PUSH
DS4UB-MX40A42-S28PE-PS	MXL (.080")	40	.999"	ALUMINUM	.28"	SLEEVE	PUSH
DS4UB-3M28A107-B58PE-PS	3mm HTD	28	1.023"	ALUMINUM	5.8mm	BALL	PUSH
DS4UB-3M28A107-S71PE-PS	3mm HTD	28	1.023"	ALUMINUM	7.1mm	SLEEVE	PUSH
DS4UB-5M17A107-B58PE-PS	5mm HTD	17	1.020"	ALUMINUM	5.8mm	BALL	PUSH
DS4UB-5M17A107-S71PE-PS	5mm HTD	17	1.020"	ALUMINUM	7.1mm	SLEEVE	PUSH
DS4UB-XL16A42-B23PE-PS	XL (1/5")	16	.999"	ALUMINUM	.23"	BALL	PUSH
DS4UB-XL16A42-S28PE-PS	XL (1/5")	16	.999"	ALUMINUM	.28"	SLEEVE	PUSH

IF A STOCK TENSIONER DOES NOT MEET YOUR REQUIREMENTS,
PLEASE CONFIGURE YOUR OWN CUSTOM TENSIONER AT
www.york-ind.com

York also manufactures custom pulleys and complete assemblies
email: support@york-ind.com web: www.york-ind.com



Size 3 Dynamic Slot Tensioners

Enhanced dynamic slot tensioner design. Self adjusting, easily locks down or let it float to suit your application.

- Linear movement inside or outside the belt
- Choice of pulleys and bearings
- Spring can push or pull pulley
- Adjusts over .50 inch range with a stroke of .25 inches
- Standard catalog item
- RoHS Compliant

DS-3

FEATURES:

The DS-3 gives you

- .21 inch minimum idler pulley clearance
- Tensioner stroke of .25 inches
- Self contained spring with 2.5 pounds continuous force, withstands 10 pounds peak
- Engineered and tested for over 1 million cycles

All York tensioners include

- Huge selection of catalog tensioners
- Universal - inside or outside tensioner
- Small footprint yet strong
- Markings to help set belt tension
- Stainless steel construction
- Aluminum or plastic idler pulleys
- Choice of flat pulley or four belt profiles: 2mm GT2, 3mm GT2, .080 (MXL) and 3mm HTD
- Sealed ball or sleeved plastic bearings
- Captive hardware for easy installation

Engineering Drawings: DS-3

DS-3 DYNAMIC SLOT TENSIONER

Strong for its size, the DS-3 Dynamic Slot tensioner allows continuous, adjustable pressure against the belt during the life of the drivetrain. Dynamic tensioners are often easier to install and improve drive serviceability in the field. Graduations on the mounting bracket allow predetermined loads to be applied during installation. And the tensioner can be locked statically into place if desired after the tension is set.

Operating Characteristics

Tensioner stroke - .25 inches (6.4 mm)

Range of adjustment - .50 inches (12.7 mm)

Maximum force against belt - 2.5 pounds (1.1 kg) continuous, 10 pounds (4.5 kg) peak

* Mounting Data:

- Approximate footprint without pulley of .95 inches (24.1 mm) wide by 2.1 inches (53.3 mm) length.
- Minimum clearance from mounting surface to bottom of pulley is .21 inches (5.3 mm) for self lubricating pulley or ball bearings. Plastic sleeve bearings require .24 inches (6.1 mm) minimum clearance.
- Requires one #6-32 threaded hole and one .125 by .50 slot. See drawing below.

** Tensioner Height:

To determine tensioner maximum height, add total end to end pulley width desired + pulley clearance from mounting surface desired = X

- If X is less than or equal to .687 (17.4 mm), tensioner height is 0.702 (17.8 mm)
- If X is greater than .687 (17.4 mm), consult York Engineering for available optional shafts and mounting bases.

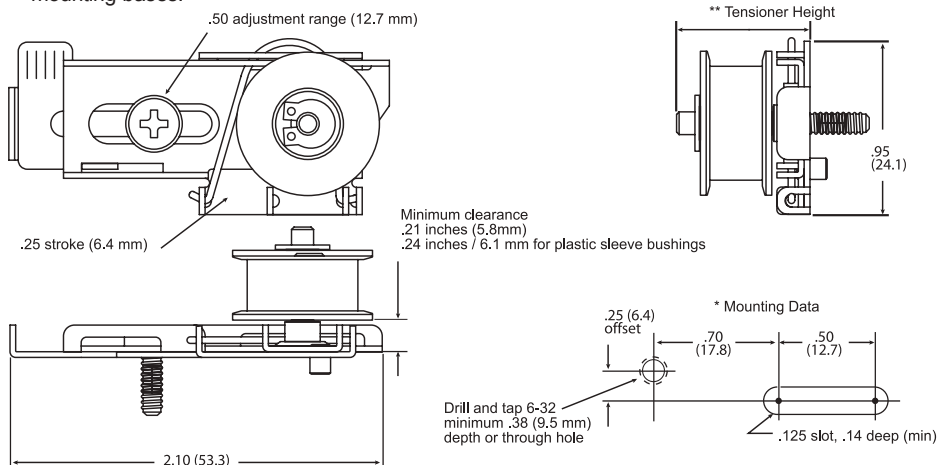

York also manufactures custom pulleys and complete assemblies
email: support@york-ind.com web: www.york-ind.com



All York Size 3 Tensioners Include:

301 stainless steel construction for strength and harsh environments	Designs tested to over one million cycles
Operating temperatures possible from -60°F to +185°F	Survives salt spray, dust, and condensing high humidity environments with proper bearings
Choice of idler pulley profiles - flat, 2mm GT2, 3mm GT2, .080 (MXL) or 3mm HTD	Idler pulleys available with sealed ball bearings, self lubricating plastic sleeves in aluminum pulleys or self lubricating all plastic pulleys
Ease of assembly with self locking, reusable Phillips hardware in 6-32 threads	Idler pulley retaining clip withstands minimum of 10 lbs (4.5 kg) pull force/side force on pulley
Downloadable CAD files for tensioners and pulleys	Dynamic tensioners have reference markings for setting belt tension during assembly and service
Free access to York's engineering staff for answers to design and application questions	Conductive grease (sealed ball bearings) or static dissipative (plastic) to prevent static electricity build-up on belts
Special mounting bushing to aid in setting belt tension.	Idler shafts are 416 stainless steel hardened to Rockwell C 38-42

Operating Environments:

Idler Pulley/Bearing Type	Maximum Operating Temperature	Minimum Operating Temperature	High Dust Environments	High Humidity	Relative Cost	Max Speed in RPM
Aluminum/Ball Bearing	185°F - may be limited by belt max temp	-60°F	Yes - Sealed ABEC Bearings With Conductive Grease	Yes	More Expensive	Limited by belt, not bearing
Aluminum/Plastic Self Lubricating Sleeve	185°F - may be limited by belt max temp	-40°F	OK in most cases	Yes	Moderate good for small and medium volumes	Up to 4,500 RPM continuous with up to 9,000 RPM peak.
One Piece Self Lubricating Carbon Filled Polycarbonate UL V94-0 Flammability	180°F	20°F (consult York for designs down to -40°F)	Generally not for extremely high dust areas	Yes - to 95% but must be non condensing	Least Expensive Need high volumes if custom mold required	Up to 4,500 RPM continuous with up to 7,000 RPM peak

IN STOCK DS-3 TENSIONERS



MAX. BELT WIDTH
1/4" (6mm)
MAX. SPRING FORCE
2.5 LBS.
MOUNTING SCREW
6-32 x 1/2

TENSIONER PART NUMBER	PULLEY PITCH	NO.OF GROOVES	PULLEY O.D.	PULLEY MATERIAL	PULLEY HEIGHT	BEARING TYPE	SPRING DIRECTION
DS3UB-F63L29-N21PE-PS	FLAT	N/A	.625"	PLASTIC	.21"	N/A	PUSH
DS3UB-F63A29-S24PE-PS	FLAT	N/A	.625"	ALUMINUM	.24"	SLEEVE	PUSH
DS3UB-F63A29-B21PE-PS	FLAT	N/A	.625"	ALUMINUM	.21"	BALL	PUSH
DS3UB-MX24A29-S24PE-PS	MXL (.080")	24	.591"	ALUMINUM	.24"	SLEEVE	PUSH
DS3UB-MX24A29-B21PE-PS	MXL (.080")	24	.591"	ALUMINUM	.21"	BALL	PUSH
DS3UB-2G24A74-S61PE-PS	2mm GT2	24	.582"	ALUMINUM	6.1mm	SLEEVE	PUSH
DS3UB-2G24A74-B53PE-PS	2mm GT2	24	.582"	ALUMINUM	5.3mm	BALL	PUSH
DS3UB-3G18A74-S61PE-PS	3mm GT2	18	.647"	ALUMINUM	6.1mm	SLEEVE	PUSH
DS3UB-3G18A74-B53PE-PS	3mm GT2	18	.647"	ALUMINUM	5.3mm	BALL	PUSH
DS3UB-3M18A74-S61PE-PS	3mm HTD	18	.647"	ALUMINUM	6.1mm	SLEEVE	PUSH
DS3UB-3M18A74-B53PE-PS	3mm HTD	18	.647"	ALUMINUM	5.3mm	BALL	PUSH

IF A STOCK TENSIONER DOES NOT MEET YOUR REQUIREMENTS,
PLEASE CONFIGURE YOUR OWN CUSTOM TENSIONER AT
www.york-ind.com

York also manufactures custom pulleys and complete assemblies
email: support@york-ind.com web: www.york-ind.com



Size 4 Static Pivot Tensioners

Radial adjustment, smallest footprint. Ideal for tight clearances and small spaces.

Choice of components.

- Rugged
- Compact
- 44 degree adjustment
- Small belt clearance
- Standard catalog item
- RoHS Compliant



FEATURES:

The SP-4 gives you

- 1.25 inch range of adjustment over 44 degree arc
- .18 inch minimum idler pulley clearance
- Up to 10 pounds of continuous force, withstands 15 pounds peak

All York tensioners include

- Huge selection of catalog tensioners
- Universal - inside or outside tensioner
- Small footprint yet strong
- Markings to help set belt tension
- Stainless steel construction
- Aluminum or plastic idler pulleys
- Choice of flat pulley or six belt profiles: 2mm GT2, 3mm GT2, MXL, 3mm HTD, 5mm HTD or XL
- Sealed ball or sleeved plastic bearings
- Captive hardware for easy installation

Engineering Drawings: SP-4

SP-4 STATIC PIVOT TENSIONER

The Static Pivot Tensioner packs up to 10 pounds of force into the smallest area of any York Size 4 tensioner. The tensioner can be used inside or outside the belt and provides up to 44 degrees of motion.

Operating Characteristics

Range of adjustment - 1.25 inches (31.8 mm) over a 44 degree arc

Maximum force against belt - 10 pounds (4.5 kg) continuous, 15 pounds (6.8 kg) peak

* Mounting Data:

- Approximate footprint without idler pulley of 1.12 inches (28.4 mm) wide by 2.25 inches (57.2 mm) long
- Minimum clearance from mounting surface to bottom of pulley is .18 inches (4.6mm) except plastic sleeve bearings require .23 inches (5.8 mm) minimum clearance.
- Requires one hole tapped 10-32 or M5 x .8 either through sheetmetal, or blind hole with minimum .38 thread depth and one .25 dia by .25 min depth clearance hole. See mounting template drawing below.

** Tensioner Height:

To find your tensioner height, determine Pulley Width + Belt Clearance desired = X

- If X is less than or equal to .600 (15.2 mm), tensioner height is 0.925 (23.5 mm)
- If X is between .600 (15.2 mm) and .875 (22.2mm), tensioner height is 1.200 (30.5 mm)
- If X is larger than .875 (22.2 mm), consult York Engineering

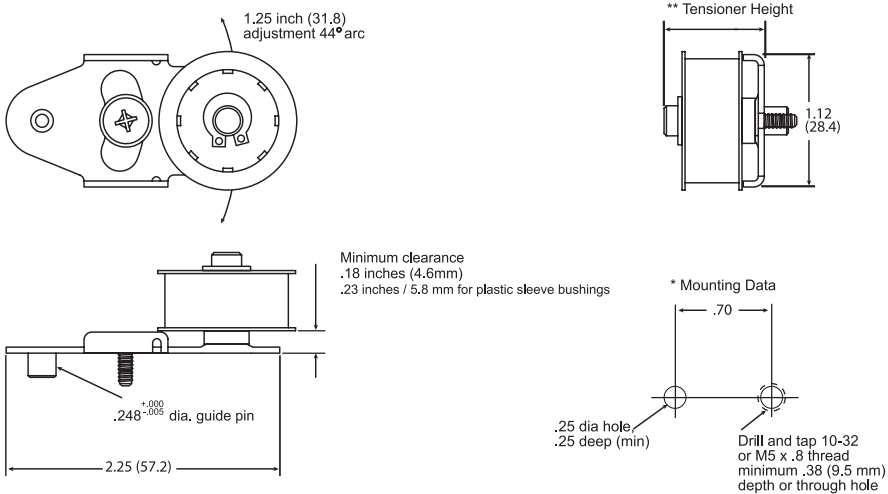

All York Size 4 Tensioners Include:

301 stainless steel construction for strength and harsh environments	Designs tested to over one million cycles
Operating temperatures possible from -60°F to +185°F	Survives salt spray, dust, and condensing high humidity environments with proper bearings
Choice of idler pulley profiles - flat, 2mm GT2, 3mm GT2, MXL, XL, 3mm HTD or 5mm HTD	Idler pulleys available with sealed ball bearings, self lubricating plastic sleeves in aluminum pulleys or self lubricating all plastic pulleys
Ease of assembly with self locking, reusable Phillips hardware in 10-32 or M5 x.8 threads	Idler pulley retaining clip withstands minimum of 15 lbs (6.8 kg) pull force
Downloadable CAD files for tensioners and pulleys	Dynamic tensioners have reference markings for setting belt tension during assembly and service
Free access to York's engineering staff for answers to design and application questions	Conductive grease (sealed ball bearings) or static dissipative (plastic) to prevent static electricity build-up on belts
Special mounting bushing to aid in setting belt tension.	Idler shafts are 416 stainless steel hardened to Rockwell C 38-42

Operating Environments:

Idler Pulley/Bearing Type	Maximum Operating Temperature	Minimum Operating Temperature	High Dust Environments	High Humidity	Relative Cost	Max Speed in RPM
Aluminum/Ball Bearing	185°F - may be limited by belt max temp	-60°F	Yes - Sealed ABEC Bearings With Conductive Grease	Yes	More Expensive	Limited by belt, not bearing
Aluminum/Plastic Self Lubricating Sleeve	185°F - may be limited by belt max temp	-40°F	OK in most cases	Yes	Moderate good for small and medium volumes	Up to 4,500 RPM continuous with up to 9,000 RPM peak.
One Piece Self Lubricating Carbon Filled Polycarbonate UL V94-0 Flammability	180°F	20°F (consult York for designs down to -40°F)	Generally not for extremely high dust areas	Yes - to 95% but must be non condensing	Least Expensive Need high volumes if custom mold required	Up to 4,500 RPM continuous with up to 7,000 RPM peak

IN STOCK SP-4 TENSIONERS



MAX. BELT WIDTH
3/8" (9mm)

MAX. CONTINUOUS FORCE
10 LBS

MOUNTING SCREW
10-32 x 1/2

TENSIONER PART NUMBER	PULLEY PITCH	NO.OF GROOVES	PULLEY O.D.	PULLEY MATERIAL	PULLEY HEIGHT	BEARING TYPE
SP4LB-F100L42-N18PE	FLAT	N/A	1"	PLASTIC	.18"	N/A
SP4LB-F100A42-B18PE	FLAT	N/A	1"	ALUMINUM	.18"	BALL
SP4LB-F100A42-S23PE	FLAT	N/A	1"	ALUMINUM	.23"	SLEEVE
SP4LB-2G40A107-B46PE	2mm GT2	40	.983"	ALUMINUM	4.6mm	BALL
SP4LB-2G40A107-S58PE	2mm GT2	40	.983"	ALUMINUM	5.8mm	SLEEVE
SP4LB-3G28A107-B46PE	3mm GT2	28	1.023"	ALUMINUM	4.6mm	BALL
SP4LB-3G28A107-S58PE	3mm GT2	28	1.023"	ALUMINUM	5.8mm	SLEEVE
SP4LB-MX40A42-B18PE	MXL (.080")	40	.999"	ALUMINUM	.18"	BALL
SP4LB-MX40A42-S23PE	MXL (.080")	40	.999"	ALUMINUM	.23"	SLEEVE
SP4LB-3M28A107-B46PE	3mm HTD	28	1.023"	ALUMINUM	4.6mm	BALL
SP4LB-3M28A107-S58PE	3mm HTD	28	1.023"	ALUMINUM	5.8mm	SLEEVE
SP4LB-5M17A107-B46PE	5mm HTD	17	1.020"	ALUMINUM	4.6mm	BALL
SP4LB-5M17A107-S58PE	5mm HTD	17	1.020"	ALUMINUM	5.8mm	SLEEVE
SP4LB-XL16A42-B18PE	XL (1/5")	16	.999"	ALUMINUM	.18"	BALL
SP4LB-XL16A42-S23PE	XL (1/5")	16	.999"	ALUMINUM	.23"	SLEEVE

IF A STOCK TENSIONER DOES NOT MEET YOUR REQUIREMENTS,
PLEASE CONFIGURE YOUR OWN CUSTOM TENSIONER AT

www.york-ind.com

York also manufactures custom pulleys and complete assemblies
email: support@york-ind.com web: www.york-ind.com



Size 3 Static Pivot Tensioners

Radial adjustment, smallest footprint. Ideal for tight clearances and small spaces.

Wide choice of idler pulleys.

- Rugged
- Compact
- 44 degree travel
- Small belt clearance
- Standard catalog item
- RoHS Compliant

SP-3



FEATURES:

The SP-3 gives you

- .73 inch range of adjustment over 44 degree arc
- .18 inch minimum idler pulley clearance
- Up to 8 pounds of continuous force, withstands 10 pounds peak

All York tensioners include

- Huge selection of catalog tensioners
- Universal - inside or outside tensioner
- Small footprint yet strong
- Markings to help set belt tension
- Stainless steel construction
- Aluminum or plastic idler pulleys
- Choice of flat pulley or four belt profiles: 2mm GT2, 3mm GT2, .080 (MXL) and 3mm HTD
- Sealed ball or sleeved plastic bearings
- Captive hardware for easy installation

Engineering Drawings: SP-3

SP-3 STATIC PIVOT TENSIONER

The smallest York Size 3 tensioner packs a punch equal to the strongest Size 3 offered. All in about one square inch of space, making this tensioner ideal for constrained areas. Tensioner works equally well inside or outside of the belt.

Operating Characteristics

Range of adjustment - .73 inches (18.5 mm) over a 44 degree arc

Maximum force against belt - 8 pounds (3.6 kg) continuous, 10 pounds (4.5 kg) peak

* Mounting Data:

- Approximate footprint without pulley of .70 inches (17.8 mm) wide by 1.36 inches (34.5 mm) long
- Minimum clearance from mounting surface to bottom of pulley is .18 inches (4.6 mm) for self lubricating pulley or ball bearings. Plastic sleeve bearings require .21 inches (5.3 mm) minimum clearance.
- Requires one #6-32 threaded hole and one .125 clearance hole. See drawing below.

** Tensioner Height:

To determine tensioner maximum height, add total end to end pulley width desired + pulley clearance from mounting surface desired = X

- If X is less than or equal to .637 (16.2 mm), tensioner height is 0.652 (16.6 mm)
- If X is greater than .637 (16.2 mm), consult York Engineering for available optional shafts and mounting bases.

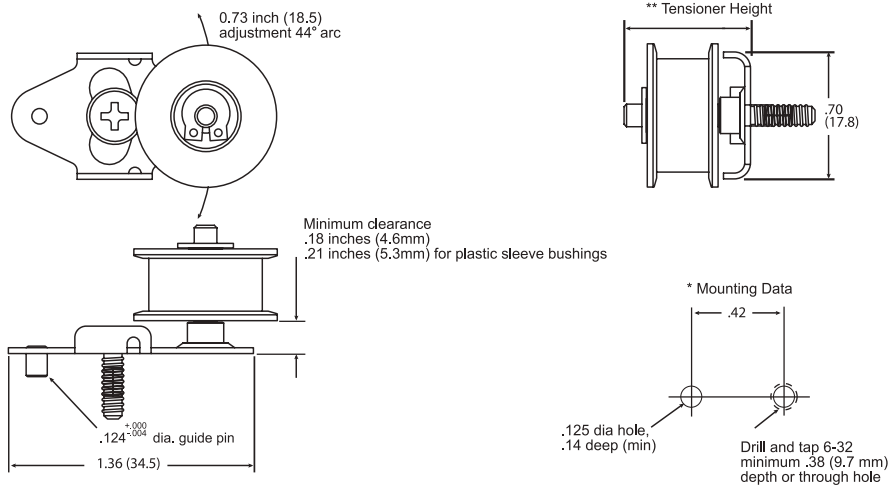

All York Size 3 Tensioners Include:

301 stainless steel construction for strength and harsh environments	Designs tested to over one million cycles
Operating temperatures possible from -60°F to +185°F	Survives salt spray, dust, and condensing high humidity environments with proper bearings
Choice of idler pulley profiles - flat, 2mm GT2, 3mm GT2, .080 (MXL) or 3mm HTD	Idler pulleys available with sealed ball bearings, self lubricating plastic sleeves in aluminum pulleys or self lubricating all plastic pulleys
Ease of assembly with self locking, reusable Phillips hardware in 6-32 threads	Idler pulley retaining clip withstands minimum of 10 lbs (4.5 kg) pull force/side force on pulley
Downloadable CAD files for tensioners and pulleys	Dynamic tensioners have reference markings for setting belt tension during assembly and service
Free access to York's engineering staff for answers to design and application questions	Conductive grease (sealed ball bearings) or static dissipative (plastic) to prevent static electricity build-up on belts
Special mounting bushing to aid in setting belt tension.	Idler shafts are 416 stainless steel hardened to Rockwell C 38-42

Operating Environments:

Idler Pulley/Bearing Type	Maximum Operating Temperature	Minimum Operating Temperature	High Dust Environments	High Humidity	Relative Cost	Max Speed in RPM
Aluminum/Ball Bearing	185°F - may be limited by belt max temp	-60°F	Yes - Sealed ABEC Bearings With Conductive Grease	Yes	More Expensive	Limited by belt, not bearing
Aluminum/Plastic Self Lubricating Sleeve	185°F - may be limited by belt max temp	-40°F	OK in most cases	Yes	Moderate good for small and medium volumes	Up to 4,500 RPM continuous with up to 9,000 RPM peak.
One Piece Self Lubricating Carbon Filled Polycarbonate UL V94-0 Flammability	180°F	20°F (consult York for designs down to -40°F)	Generally not for extremely high dust areas	Yes - to 95% but must be non condensing	Least Expensive Need high volumes if custom mold required	Up to 4,500 RPM continuous with up to 7,000 RPM peak

IN STOCK SP-3 TENSIONERS



MAX. BELT WIDTH
1/4" (6mm)
MAX. CONTINUOUS FORCE
8 LBS
MOUNTING SCREW
6-32 x 1/2

TENSIONER PART NUMBER	PULLEY PITCH	NO.OF GROOVES	PULLEY O.D.	PULLEY MATERIAL	PULLEY HEIGHT	BEARING TYPE
SP3LB-F63L29-N18PE	FLAT	N/A	.625"	PLASTIC	.21"	N/A
SP3LB-F63A29-S21PE	FLAT	N/A	.625"	ALUMINUM	.24"	SLEEVE
SP3LB-F63A29-B18PE	FLAT	N/A	.625"	ALUMINUM	.21"	BALL
SP3LB-MX24A29-S21PE	MXL (.080")	24	.591"	ALUMINUM	.24"	SLEEVE
SP3LB-MX24A29-B18PE	MXL (.080")	24	.591"	ALUMINUM	.21"	BALL
SP3LB-2G24A74-S53PE	2mm GT2	24	.582"	ALUMINUM	6.1mm	SLEEVE
SP3LB-2G24A74-B46PE	2mm GT2	24	.582"	ALUMINUM	5.3mm	BALL
SP3LB-3G18A74-S53PE	3mm GT2	18	.647"	ALUMINUM	6.1mm	SLEEVE
SP3LB-3G18A74-B46PE	3mm GT2	18	.647"	ALUMINUM	5.3mm	BALL
SP3LB-3M18A74-S53PE	3mm HTD	18	.647"	ALUMINUM	6.1mm	SLEEVE
SP3LB-3M18A74-B46PE	3mm HTD	18	.647"	ALUMINUM	5.3mm	BALL

IF A STOCK TENSIONER DOES NOT MEET YOUR REQUIREMENTS,
PLEASE CONFIGURE YOUR OWN CUSTOM TENSIONER AT
www.york-ind.com

Size 4 Static Slot Tensioners

The classic tensioner. Linear motion, cost effective when space permits, and a wide range of component choices.

- Universal tensioner
- Over 3/4 inch of adjustment
- Choice of bearings and pulleys
- Easy installation
- Standard catalog item
- RoHS Compliant



FEATURES:

The SS-4 gives you

- .80 inch range of adjustment
- .18 inch minimum idler pulley clearance
- Up to 10 pounds continuous force, withstands 15 pounds peak

All York tensioners include

- Huge selection of catalog tensioners
- Universal - inside or outside tensioner
- Small footprint yet strong
- Markings to help set belt tension
- Stainless steel construction
- Aluminum or plastic idler pulleys
- Choice of flat pulley or six belt profiles: 2mm GT2, 3mm GT2, MXL, 3mm HTD, 5mm HTD or XL
- Sealed ball or sleeved plastic bearings
- Captive hardware for easy installation

Engineering Drawings: SS-4

SS- 4 STATIC SLOT TENSIONER

The Static Slot Tensioner is the classic tensioner design. It works equally well outside or inside the belt, if there is enough room for an inside installation. Plus it can even function as an idler pulley to change the belt direction or increase the teeth in mesh. York offers an engineered, catalog solution to the need for a tensioner in a belt drive system.

Operating Characteristics

Range of adjustment - .80 inches (20 mm)

Maximum force against belt - 10 pounds (4.5 kg) continuous, 15 pounds (6.8 kg) peak

* Mounting Data:

- Approximate footprint without idler pulley of .90 inches (22.9 mm) wide by 2.6 inches (66.0 mm) long
- Minimum clearance from mounting surface to bottom of pulley is .18 inches (4.6 mm) except plastic sleeve bearings require .23 inches (5.8 mm) minimum clearance.
- Requires one hole tapped 10-32 or M5 x .8 either through sheetmetal, or blind hole with minimum .38 thread depth. See drawing below.

** Tensioner Height:

To find your tensioner height, determine Pulley Width + Belt Clearance desired = X

- If X is less than or equal to .600 (15.2 mm), tensioner height is 0.925 (23.5 mm)
- If X is between .600 (15.2 mm) and .875 (22.2 mm), tensioner height is 1.200 (30.5 mm)
- If X is larger than .875 (22.2 mm), consult York Engineering

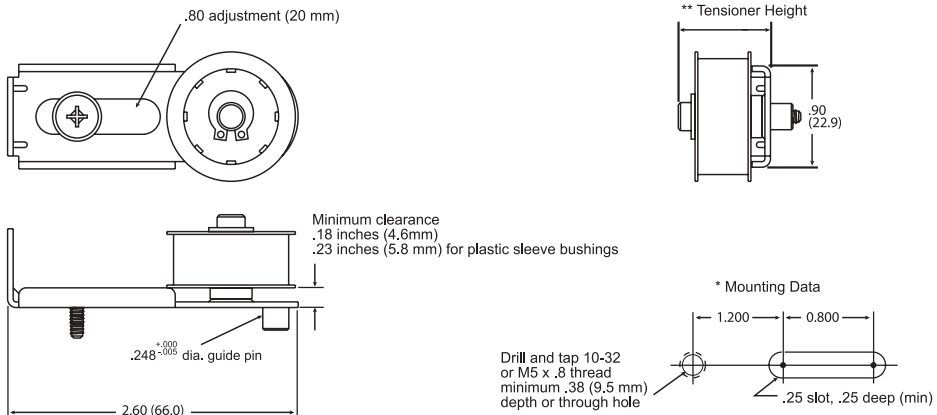

All York Size 4 Tensioners Include:

301 stainless steel construction for strength and harsh environments	Designs tested to over one million cycles
Operating temperatures possible from -60°F to +185°F	Survives salt spray, dust, and condensing high humidity environments with proper bearings
Choice of idler pulley profiles - flat, 2mm GT2, 3mm GT2, MXL, XL, 3mm HTD or 5mm HTD	Idler pulleys available with sealed ball bearings, self lubricating plastic sleeves in aluminum pulleys or self lubricating all plastic pulleys
Ease of assembly with self locking, reusable Phillips hardware in 10-32 or M5 x.8 threads	Idler pulley retaining clip withstands minimum of 15 lbs (6.8 kg) pull force
Downloadable CAD files for tensioners and pulleys	Dynamic tensioners have reference markings for setting belt tension during assembly and service
Free access to York's engineering staff for answers to design and application questions	Conductive grease (sealed ball bearings) or static dissipative (plastic) to prevent static electricity build-up on belts
Special mounting bushing to aid in setting belt tension.	Idler shafts are 416 stainless steel hardened to Rockwell C 38-42

Operating Environments:

Idler Pulley/Bearing Type	Maximum Operating Temperature	Minimum Operating Temperature	High Dust Environments	High Humidity	Relative Cost	Max Speed in RPM
Aluminum/Ball Bearing	185°F - may be limited by belt max temp	-60°F	Yes - Sealed ABEC Bearings With Conductive Grease	Yes	More Expensive	Limited by belt, not bearing
Aluminum/Plastic Self Lubricating Sleeve	185°F - may be limited by belt max temp	-40°F	OK in most cases	Yes	Moderate good for small and medium volumes	Up to 4,500 RPM continuous with up to 9,000 RPM peak.
One Piece Self Lubricating Carbon Filled Polycarbonate UL V94-0 Flammability	180°F	20°F (consult York for designs down to -40°F)	Generally not for extremely high dust areas	Yes - to 95% but must be non condensing	Least Expensive Need high volumes if custom mold required	Up to 4,500 RPM continuous with up to 7,000 RPM peak

IN STOCK SS-4 TENSIONERS



MAX. BELT WIDTH
3/8" (9mm)

MAX. CONTINUOUS FORCE
10 LBS

MOUNTING SCREW
10-32 x 1/2

TENSIONER PART NUMBER	PULLEY PITCH	NO.OF GROOVES	PULLEY O.D.	PULLEY MATERIAL	PULLEY HEIGHT	BEARING TYPE
SS4LB-F100L42-N18PE	FLAT	N/A	1"	PLASTIC	.18"	N/A
SS4LB-F100A42-B18PE	FLAT	N/A	1"	ALUMINUM	.18"	BALL
SS4LB-F100A42-S23PE	FLAT	N/A	1"	ALUMINUM	.23"	SLEEVE
SS4LB-2G40A107-B46PE	2mm GT2	40	.983"	ALUMINUM	4.6mm	BALL
SS4LB-2G40A107-S58PE	2mm GT2	40	.983"	ALUMINUM	5.8mm	SLEEVE
SS4LB-3G28A107-B46PE	3mm GT2	28	1.023"	ALUMINUM	4.6mm	BALL
SS4LB-3G28A107-S58PE	3mm GT2	28	1.023"	ALUMINUM	5.8mm	SLEEVE
SS4LB-MX40A42-B18PE	MXL (.080")	40	.999"	ALUMINUM	.18"	BALL
SS4LB-MX40A42-S23PE	MXL (.080")	40	.999"	ALUMINUM	.23"	SLEEVE
SS4LB-3M28A107-B46PE	3mm HTD	28	1.023"	ALUMINUM	4.6mm	BALL
SS4LB-3M28A107-S58PE	3mm HTD	28	1.023"	ALUMINUM	5.8mm	SLEEVE
SS4LB-5M17A107-B46PE	5mm HTD	17	1.020"	ALUMINUM	4.6mm	BALL
SS4LB-5M17A107-S58PE	5mm HTD	17	1.020"	ALUMINUM	5.8mm	SLEEVE
SS4LB-XL16A42-B18PE	XL (1/5")	16	.999"	ALUMINUM	.18"	BALL
SS4LB-XL16A42-S23PE	XL (1/5")	16	.999"	ALUMINUM	.23"	SLEEVE

IF A STOCK TENSIONER DOES NOT MEET YOUR REQUIREMENTS,
PLEASE CONFIGURE YOUR OWN CUSTOM TENSIONER AT
www.york-ind.com

York also manufactures custom pulleys and complete assemblies
email: support@york-ind.com web: www.york-ind.com



Size 3 Static Slot Tensioners

The classic tensioner in a small package. Linear motion, cost effective and a wide range of component choices.

- Universal tensioner
- 1/2 inch of adjustment
- Choice of bearings and pulleys
- Easy installation
- Standard catalog item
- RoHS Compliant

SS-3

FEATURES:

The SS-3 gives you

- .50 inch range of adjustment
- .18 inch minimum idler pulley clearance
- Up to 8 pounds continuous force, withstands 10 pounds peak

All York tensioners include

- Huge selection of catalog tensioners
- Universal - inside or outside tensioner
- Small footprint yet strong
- Markings to help set belt tension
- Stainless steel construction
- Aluminum or plastic idler pulleys
- Choice of flat pulley or four belt profiles 2mm GT2, 3mm GT2, MXL, or 3mm HTD
- Sealed ball or sleeved plastic bearings
- Captive hardware for easy installation

Engineering Drawings: SS-3

SS- 3 STATIC SLOT TENSIONER

This size Static Slotted Tensioner provides a compact but strong tensioner for designs that have smaller belt widths and tight space constraints. It fits well both inside or outside the belt. It also allows changes in belt direction or increased teeth in mesh in very small areas.

Operating Characteristics

Range of adjustment - .50 inches (12.7 mm)

Maximum force against belt - 2.5 pounds (1.1 kg) continuous, 10 pounds (4.5 kg) peak

* Mounting Data:

- Approximate footprint without pulley of .85 inches (21.2 mm) wide by 1.8 inches (45.7 mm) length
- Minimum clearance from mounting surface to bottom of pulley is .18 inches (4.6 mm) for self lubricating pulley or ball bearings. Plastic sleeve bearings require .21 inches (5.3 mm) minimum clearance.
- Requires one #6-32 threaded hole and one .125 by .50 slot. See drawing below.

** Tensioner Height:

To determine tensioner maximum height, add total end to end pulley width desired + pulley clearance from mounting surface desired = X

- If X is less than or equal to .637 (16.2 mm), tensioner height is 0.652 (16.6 mm)
- If X is greater than .637 (16.2 mm), consult York Engineering for available optional shafts and mounting bases.

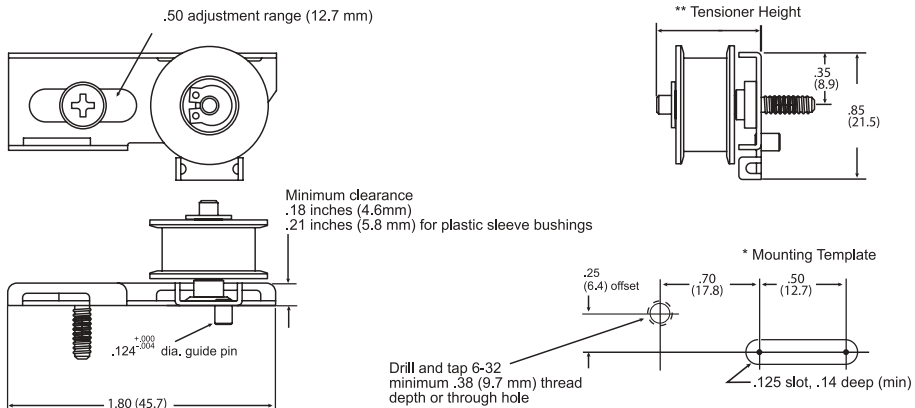

All York Size 3 Tensioners Include:

301 stainless steel construction for strength and harsh environments	Designs tested to over one million cycles
Operating temperatures possible from -60°F to +185°F	Survives salt spray, dust, and condensing high humidity environments with proper bearings
Choice of idler pulley profiles - flat, 2mm GT2, 3mm GT2, .080 (MXL) or 3mm HTD	Idler pulleys available with sealed ball bearings, self lubricating plastic sleeves in aluminum pulleys or self lubricating all plastic pulleys
Ease of assembly with self locking, reusable Phillips hardware in 6-32 threads	Idler pulley retaining clip withstands minimum of 10 lbs (4.5 kg) pull force/side force on pulley
Downloadable CAD files for tensioners and pulleys	Dynamic tensioners have reference markings for setting belt tension during assembly and service
Free access to York's engineering staff for answers to design and application questions	Conductive grease (sealed ball bearings) or static dissipative (plastic) to prevent static electricity build-up on belts
Special mounting bushing to aid in setting belt tension.	Idler shafts are 416 stainless steel hardened to Rockwell C 38-42

Operating Environments:

Idler Pulley/Bearing Type	Maximum Operating Temperature	Minimum Operating Temperature	High Dust Environments	High Humidity	Relative Cost	Max Speed in RPM
Aluminum/Ball Bearing	185°F - may be limited by belt max temp	-60°F	Yes - Sealed ABEC Bearings With Conductive Grease	Yes	More Expensive	Limited by belt, not bearing
Aluminum/Plastic Self Lubricating Sleeve	185°F - may be limited by belt max temp	-40°F	OK in most cases	Yes	Moderate good for small and medium volumes	Up to 4,500 RPM continuous with up to 9,000 RPM peak.
One Piece Self Lubricating Carbon Filled Polycarbonate UL V94-0 Flammability	180°F	20°F (consult York for designs down to -40°F)	Generally not for extremely high dust areas	Yes - to 95% but must be non condensing	Least Expensive Need high volumes if custom mold required	Up to 4,500 RPM continuous with up to 7,000 RPM peak

IN STOCK SS-3 TENSIONERS



MAX. BELT WIDTH
1/4" (6mm)
MAX. CONTINUOUS FORCE
8 LBS
MOUNTING SCREW
6-32 x 1/2

TENSIONER PART NUMBER	PULLEY PITCH	NO.OF GROOVES	PULLEY O.D.	PULLEY MATERIAL	PULLEY HEIGHT	BEARING TYPE
SS3LB-F63L29-N18PE	FLAT	N/A	.625"	PLASTIC	.18"	N/A
SS3LB-F63A29-S21PE	FLAT	N/A	.625"	ALUMINUM	.21"	SLEEVE
SS3LB-F63A29-B18PE	FLAT	N/A	.625"	ALUMINUM	.18"	BALL
SS3LB-MX24A29-S21PE	MXL (.080")	24	.591"	ALUMINUM	.21"	SLEEVE
SS3LB-MX24A29-B18PE	MXL (.080")	24	.591"	ALUMINUM	.18"	BALL
SS3LB-2G24A74-S53PE	2mm GT2	24	.582"	ALUMINUM	5.3mm	SLEEVE
SS3LB-2G24A74-B46PE	2mm GT2	24	.582"	ALUMINUM	4.6mm	BALL
SS3LB-3G18A74-S53PE	3mm GT2	18	.647"	ALUMINUM	5.3mm	SLEEVE
SS3LB-3G18A74-B46PE	3mm GT2	18	.647"	ALUMINUM	4.6mm	BALL
SS3LB-3M18A74-S53PE	3mm HTD	18	.647"	ALUMINUM	5.3mm	SLEEVE
SS3LB-3M18A74-B46PE	3mm HTD	18	.647"	ALUMINUM	4.6mm	BALL

IF A STOCK TENSIONER DOES NOT MEET YOUR REQUIREMENTS,
PLEASE CONFIGURE YOUR OWN CUSTOM TENSIONER AT
www.york-ind.com

Mounting Your Tensioner With Spacers

York tensioners are designed to mount securely with just a single screw onto a flat surface. The tensioners allow minimal clearance between the belt and mounting surface to allow maximum flexibility in the drive design. Where greater belt clearances are required, York can customize the height of the idler on the shaft, customize the shaft length, or provide standard extruded and machined anodized aluminum spacers to increase the tensioner mounting height. Spacers are available in custom thicknesses while standard catalog spacers of .38 inches thick (9.7mm) for Size 4 and .25 inches (6.4mm) for Size 3 tensioners are always available from stock. Up to 3 spacers can be used under a tensioner when increased height is needed. All spacers are anodized for use in harsh environments and fit within the same footprint as the tensioner itself. Contact York for more details, custom thicknesses, or unique idler pulley heights and clearances. Go to www.york-ind.com/spacers for downloadable spacer drawings and CAD files.

For DP-4 Tensioners

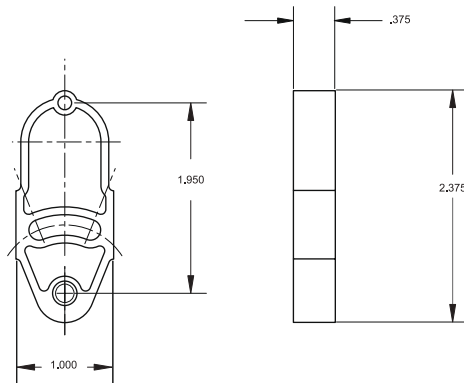

DP-4 Spacer
Type 74-012-xxx

Material - Aluminum
 Applied Finish - Clear Anodize

For DS-4 Tensioners

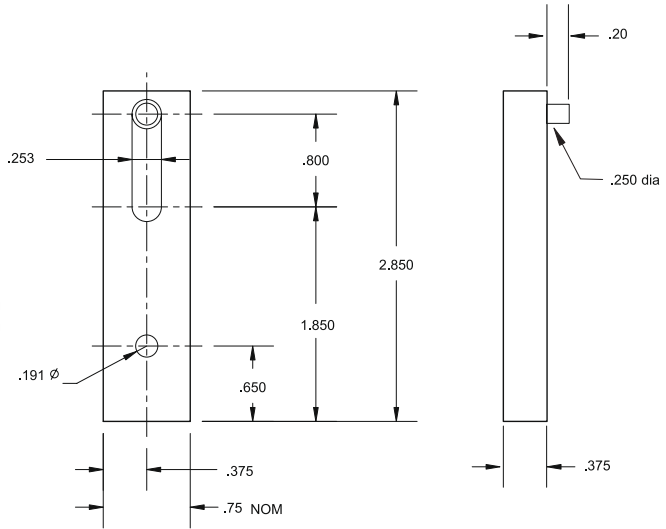

DS-4 Spacer
Type 74-013-xxx

Material - Aluminum
Applied Finish - Clear Anodize

For SP-4 Tensioners

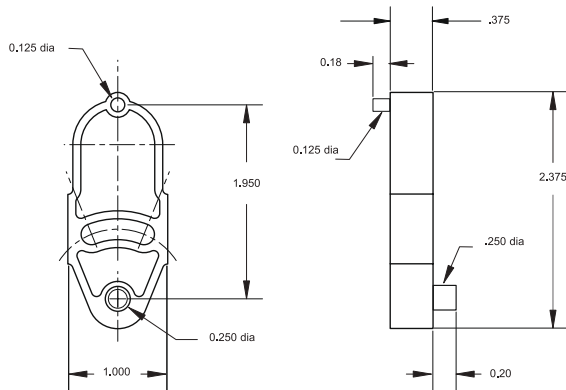

SP-4 Spacer
Type 74-010-xxx

Material - Aluminum
Applied Finish - Clear Anodize

York also manufactures custom pulleys and complete assemblies
email: support@york-ind.com web: www.york-ind.com



For SS-4 Tensioners

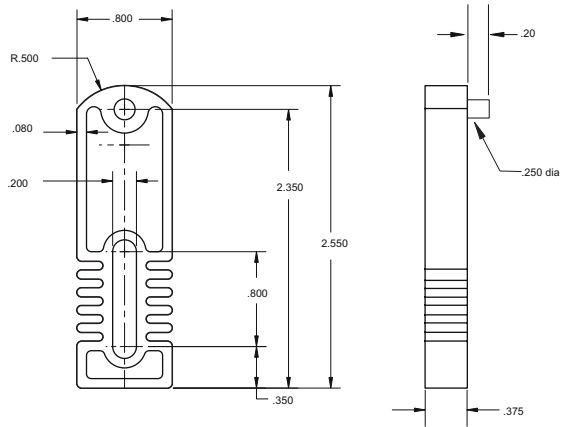

SS-4 Spacer
Type 74-011-xxx

Material - Aluminum
Applied Finish - Clear Anodize

For DP-3 Tensioners

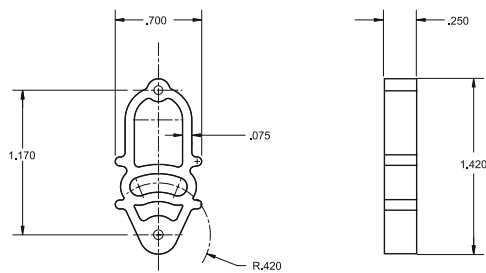

DP-3 Spacer
Type 74-512-xxx

Material - Aluminum
Applied Finish - Clear Anodize

For DS-3 Tensioners

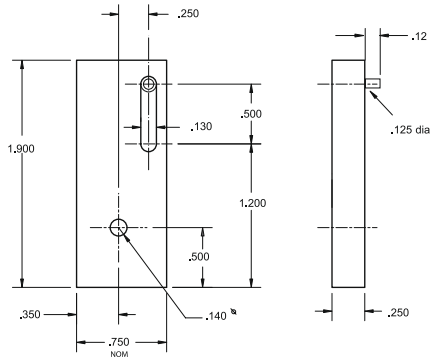

Material - Aluminum
Applied Finish - Clear Anodize

DS-3 Spacer
Type 74-513-xxx

For SP-3 Tensioners

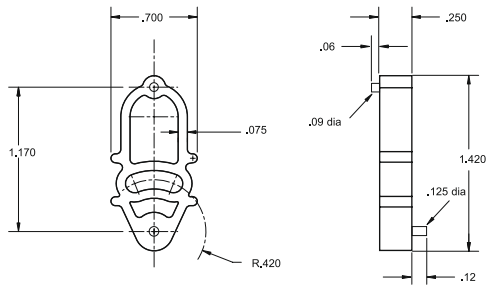

Material - Aluminum
Applied Finish - Clear Anodize

SP-3 Spacer
Type 74-510-xxx

For SS-3 Tensioners



SS-3 Spacer
Type 74-511-xxx

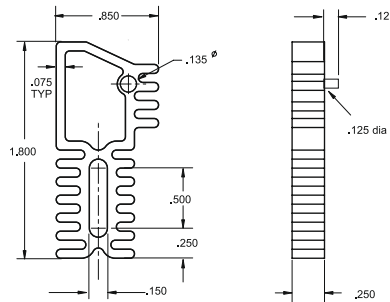

Material - Aluminum
Applied Finish - Clear Anodize

CUSTOM PULLEYS & ASSEMBLIES

CUSTOM PULLEYS &
ASSEMBLIES

York Industries

Manufacturing to customized specifications, and providing specialized design assistance, fast turnaround at every stage from prototype to production, and award winning quality since 1942.

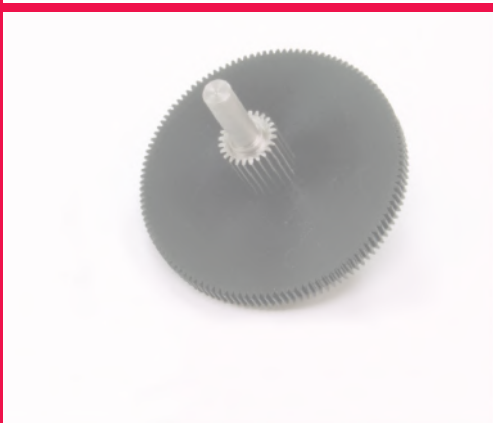

CUSTOM PULLEYS &
ASSEMBLIES

CUSTOM PULLEYS AND ASSEMBLIES

PULLEYS

Whether you require prototype or production quantities, York Industries can manufacture custom pulleys in a wide range of pitches, precisely to your print specifications. We do this in a variety of materials, including steel, aluminum, brass, bronze and machined plastic, and we offer a quick turnaround on your prototype requirements.

ASSEMBLIES

Purchasing higher-level assemblies from York Industries will save you both time and money. You need purchase only a single part number, as opposed to ordering multiple part numbers from a variety of sources. Assemblies can include bearings, clutches, shafts and other components. York has the latest computerized manufacturing and inspection equipment, assuring that only precision parts of the highest quality are produced. York is ISO 9001:2008 certified.

If you have custom gear or gear assembly requirements and would like a prompt quote, just email your prints or specifications to support@york-ind.com or fax to 800-354-8485.

26 Purchased Items?



OR

1 Purchased Assembly?





York also manufactures custom pulleys and complete assemblies
email: support@york-ind.com web: www.york-ind.com



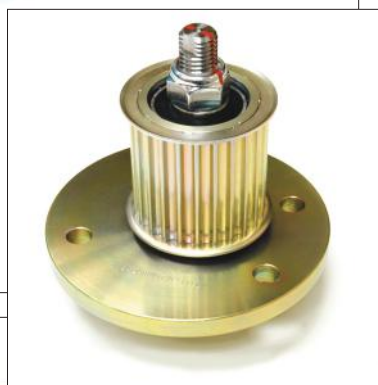
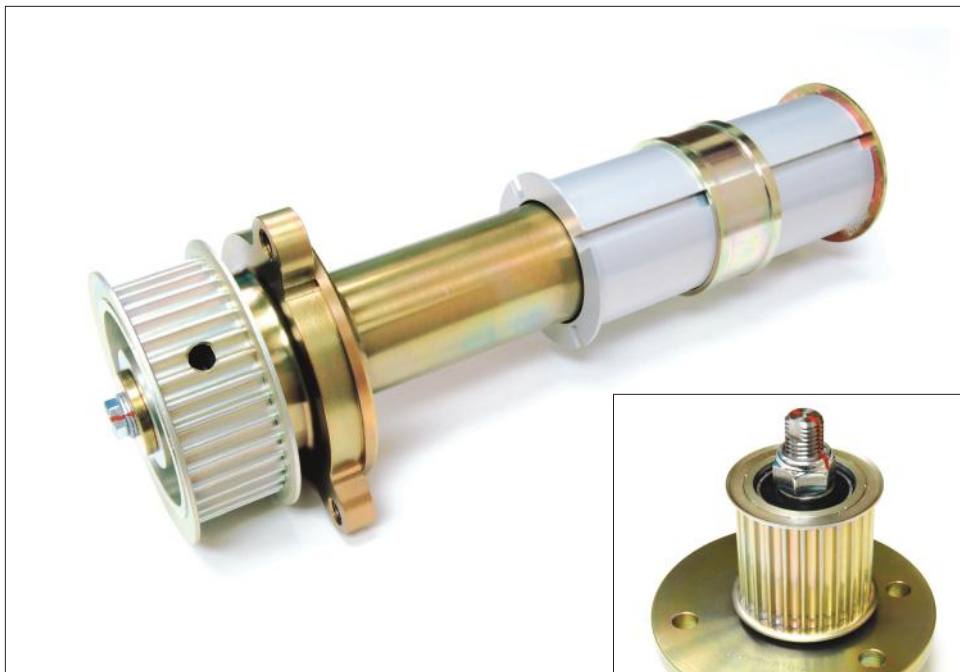

CUSTOM PULLEYS AND ASSEMBLIES



York also manufactures custom pulleys and complete assemblies
email: support@york-ind.com web: www.york-ind.com





CUSTOM GEARS & ASSEMBLIES

CUSTOM GEARS &
ASSEMBLIES

York Industries

Manufacturing to customized specifications, and providing specialized design assistance, fast turnaround at every stage from prototype to production, and award winning quality since 1942.



CUSTOM GEARS AND ASSEMBLIES

GEARS

York Industries manufactures gears in pitches that range from 6 DP to 120 DP, including metric (module) pitches. We can provide everything from prototype to production quantities for virtually any gear type, including:

- Helical Gears
- Spur Gears
- Worms
- Worm gears
- Gear racks
- Sprockets

Whether you require prototype or production quantities, York manufactures both custom gears and full gear assemblies to your print specifications. We do this in a variety of materials, including steel, aluminum, brass, bronze and machined plastic, and we offer quick turnaround on your prototype requirements.

ASSEMBLIES

Purchasing higher-level gear assemblies from York Industries will save you both time and money. You need purchase only a single part number, as opposed to ordering multiple part numbers from a variety of sources. Assemblies can include bearings, clutches, shafts and other components. York has the latest computerized manufacturing and inspection equipment, assuring that only precision parts of the highest quality are produced. York is ISO 9001:2008 certified.

If you have custom gear or gear assembly requirements and would like a prompt quote, just email your prints or specifications to support@york-ind.com or fax to 800-354-8485.

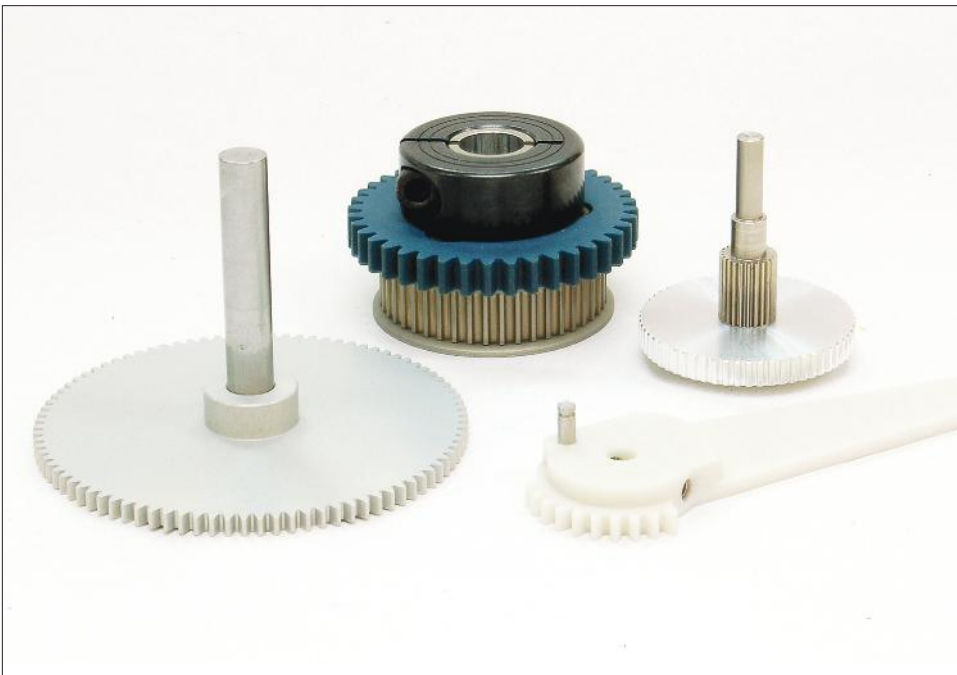

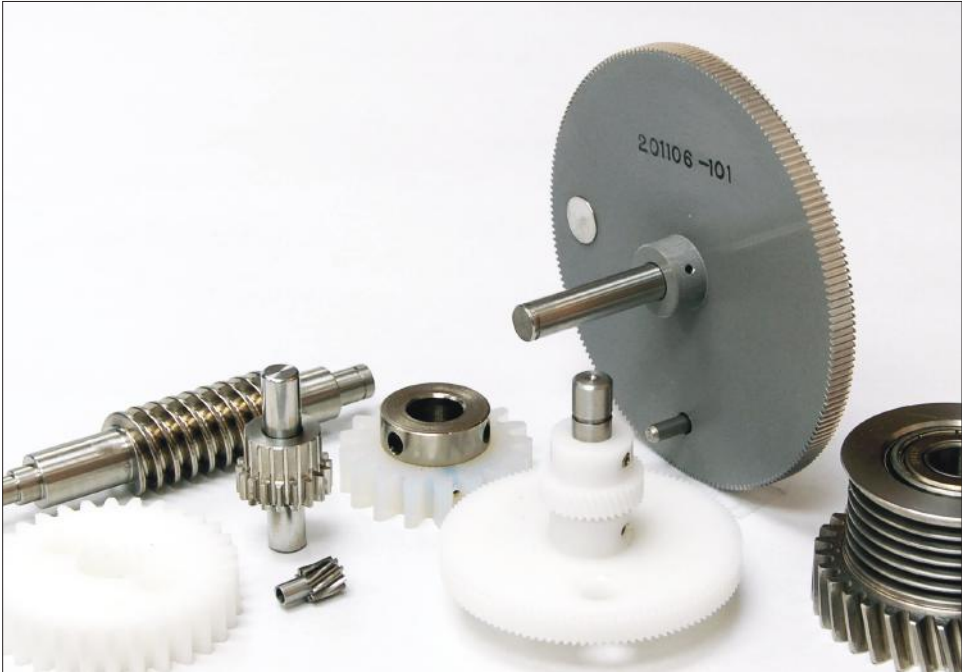

York also manufactures custom pulleys and complete assemblies
email: support@york-ind.com web: www.york-ind.com







YORK
INDUSTRIES
ISO 9001 : 2008

Quality Manufacturing since 1942

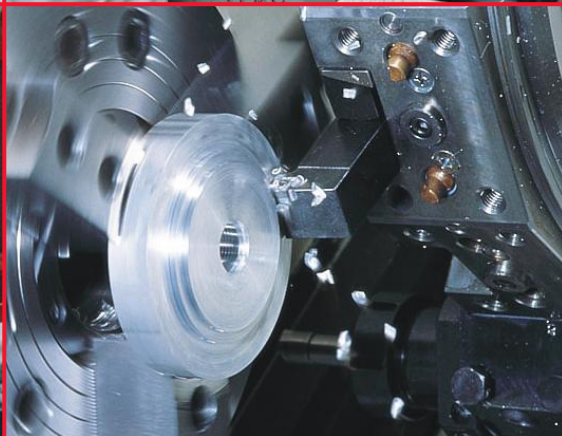
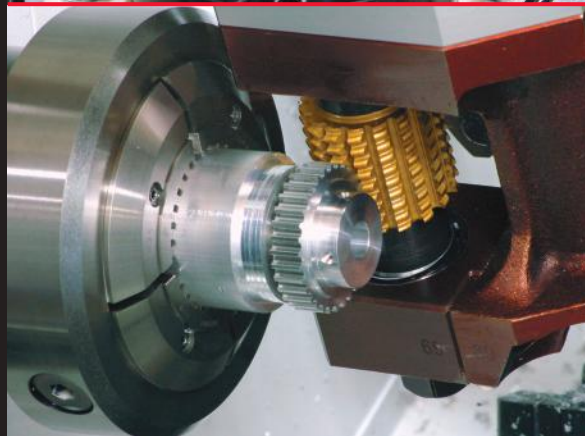
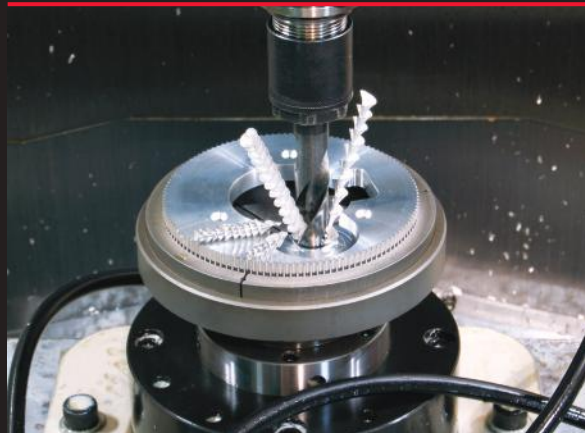

- **Manufacturer of Custom and Standard Timing Pulleys, Gears, Assemblies, Tensioners**
- **Supplier of Timing Belts**
- **Engineering Support**
- **One on One Customer Service**
- **Over 70 years of exceeding customer expectations**

303 Nassau Blvd., Garden City Park, NY 11040
toll free: 800-354-8466 • tel: 516-746-3736 • fax: 800-354-8485 • www.york-ind.com